

The Last Resort



The Last Resort

*Hints for Guerrillas, Terrorists, and
Concerned Citizens.*

2022 Edition – Expanded and Edited.

The Last Resort: Hints for Guerrillas, Terrorists, and Concerned Citizens. 2022 Edition – Expanded and Edited.

Compiled, edited and partly edited by a concerned citizen.

Published 01/01/2022.

This document can freely be shared, printed, sold and circulated without the given consent of the author(s).

Based on “The Last Resort” published 11/24/2021.

Published by Concerned Citizen Publishing.

Contact us!*

@concerned_citizen:matrix.org

*With an encryption and possibly a tor or anonymous proxy!

We check our matrix possibly once a week. Why contact us?

- Verify the information in our documents.
- Provide your own information to us.
- Give us new ideas for future documents.



Table Of Contents

- 9 – Measurements.
- 10 – Introduction.
- 12 – Before operations.
 - 12 – Preparing for the operation.
 - 15 – Characteristics of the urban guerrilla.
 - 20 – Lifestyle recommendations.
 - 23 – Avoiding suspicion.
 - 23 – Acquiring firearms in France.
 - 24 – Laboratory.
- 29 – Additional hints.
 - 29 – Secret meetings.
 - 31 – Dealing with law enforcement.
 - 33 – How to leave behind no evidence.
 - 38 – Manufacturing explosives – worth it or not?
- 39 – “Prepping” and base maintenance.
 - 39 – What to stockpile.
 - 39 – Food.
 - 41 – Water.
 - 43 – Avoiding fires.
 - 44 – Electricity.
 - 44 – Generators.
 - 46 – Storing off-grid electricity.
- 48 – Foreign volunteering.
 - 49 – What to expect in foreign warfare.
 - 51 – Fugitive.
 - 52 – Risks of volunteering.
- 53 – Technology and security.
 - 53 – Hardware.
 - 54 – Operating systems.
 - 55 – Other tech.
 - 57 – Tor.
 - 58 – Communications.
 - 65 – Cryptocurrency.
 - 65 – Dissemination.
 - 66 – Honey pots.
- 68 – Explosives.
 - 69 – Match-heads.
 - 69 – Nitroglycerin.
 - 70 – Dynamite.
 - 71 – TATP.
 - 72 – Mercury(II) fulminate.
 - 73 – DDNP.
 - 77 – HMTD.
 - 79 – Double salts.
 - 80 – Lead azide.
 - 81 – Chlorate mixture.
 - 82 – Black powder.
 - 82 – Fireworks.

- 83 – Picric acid.
- 87 – Nitrocellulose.
- 88 – Urea nitrate.
- 89 – Ammonal/Tannerite.
- 89 – ANFO.
- 90 – ANNM.
- 93 – How to make ANFO/ANNM more potent.
- 93 – Propane.
- 99 – Other chemicals.
 - 99 – Sulfuric acid.
 - 99 – Nitric acid.
 - 100 – Piranha solution.
 - 102 – Napalm.
 - 103 – Ammonium nitrate.
 - 106 – Purification.
 - 107 – Grinding.
 - 108 – Further hints.
 - 110 – Farming for AN.
 - 114 – PTFE (Teflon).
- 118 – Trigger mechanisms and bomb designs.
 - 118 – Detonator.
 - 120 – Fuse.
 - 120 – Decorative lamp detonator.
 - 121 – Mercury switch.
 - 121 – Tripwire switch.
 - 122– Door trap.
 - 124 – Time bomb.
 - 126 – Remote control bomb.
 - 132 – Mail bomb (push switch igniter).
 - 137 – Magnet bomb (electric wind switch).
 - 139 – Grenade ignition system.
 - 140 – Electric grenade ignition system.
 - 142 – Pipe bomb.
 - 144 – Car bomb.
 - 145 – Examples.
 - 150 – Hardness of materials.
- 152 – Ammunition.
 - 154 – Reusing ammunition.
 - 154 – Improvised ammunition.
 - 154– Bullets.
 - 161 – Poison bullets.
 - 163 – Armor penetration bullets.
 - 173 – Bullet sizing die.
 - 174 – Shell casings.
 - 177 – Primers.
 - 179 – Using blanks as primers.
 - 181 – Propellant.
 - 182 – Bullet seating equipment.
 - 182 – Assembling ammunition.
 - 187 – Full metal jacket.

- 187 – Shotgun ammunition.
- 192 – Round diagrams.
- 198 – Firearms.
 - 198 – Nomenclature.
 - 204 – Safety and handling.
 - 205 – Cleaning.
 - 207 – Handguns.
 - 209 – Shotguns.
 - 214 – Rifles.
 - 220 – Common firearms.
 - 226 – AR-15 to automatic.
 - 232– Gunfights.
 - 234 – Cover.
 - 234 – WW2 films.
- 236 – Improvised firearms.
 - 236 – Slamfire shotgun.
 - 237 – Flamethrower.
 - 237 – Online resources.
 - 238 – King Cobra .22.
 - 249 – Break-action shotgun.
 - 263 – K6-92.
 - 284 – MAC-10.
 - 306 – Milling machine considerations.
 - 320 – Semi-automatic rifle.
 - 333 – Improvised silencer.
- 335 – Specialized clothing.
 - 335 – Ballistic armor.
 - 336 – Camouflage.
- 340 – Sniper training.
 - 343 – Equipment.
 - 351 – Marksmanship.
 - 362 – Holdoff.
 - 364 – Ballistics.
 - 374 – Estimating range.
 - 378 – Data book.
- 381 – Poisons.
 - 382 – Nicotine.
 - 385 – Ricin.
 - 386 – Potassium cyanide.
 - 387 – Hydrogen cyanide.
 - 388 – Cyanide antidote.
 - 388 – Chlorine gas.
 - 389 – Gas masks.
 - 390 – Kidnapping drugs.
- 391 – Vehicles.
 - 391 – Vehicle security.
 - 393 – Getaway driving.
 - 409 – Ramming attacks.
 - 410 – Killdozer.
 - 411 – Car theft.

- 413 – Drones.
 - 413 – Software.
 - 414 – Loitering munition.
- 415 – Close-quarters combat.
 - 415 – Knives.
 - 420 – Other melee weapons.
 - 421 – Unarmed combat.
- 423 – Sabotage.
 - 423 – Vandalism.
 - 423 – Roadblocks.
 - 426 – Denial.
 - 427 – Arson.
 - 428 – Buildings.
 - 429 – Wildfires.
 - 430 – “Pillows”.
- 431 – Harassment.
 - 431 – Doxing.
- 434 – Mass-shooting operations.
 - 434 – Targets.
 - 435 – Armory.
 - 436 – Maximizing fatalities.
- 437 – Guerrilla organization.
 - 437 – Clandestine cell systems.
 - 440 – Front organization.
 - 442 – Recruiting.
 - 444 – Equipment.
 - 446 – Diplomacy.
- 447 – Guerrilla tactics.
 - 452 – Rescue of the wounded.
 - 453 – Examples.
 - 453 – Ambush.
 - 455 – Raid.
 - 457 – Disengagement.
 - 458 – Securing the rest area.
- 459 – Survival tips.
 - 459 – Starting fires.
 - 466 – Filtering water.
 - 466 – Emergency rations.
 - 467 – Backpack.
 - 468 – Shelter
- 479 – Medical field procedures.
 - 480 – Lifesaving measures.
 - 493 – Wounds.
 - 516 – Chemical, biological, and nuclear casualties.
 - 522 – Common emergencies.
 - 527 – Seasonal hazards.
 - 530 – Drug abuse and emotional problems.
 - 534 – Common drugs and their usage.
 - 536 – Nontraumatic disease.
 - 539 – Diseases of the skin.

- 549 – Disease of the musculoskeletal system.
- 554 – Diseases of the respiratory system.
- 562 – Diseases of the circulatory system.
- 568 – Diseases of the digestive system.
- 576 – Diseases of the genitourinary system.
- 582 – Diseases of the nervous system.
- 586 – Manifesto.
- 586 – Arming the people.
- 587 – Accelerationism.
- 587 – Nonsense.
- 587 – Last words.
- 588 – Letter by a special someone.

IMPERIAL

METRIC

LINEAR MEASURE (LENGTH/DISTANCE)

IMPERIAL	METRIC
1 inch	25.4 millimetres
1 foot (=12 inches)	0.3048 metre
1 yard (=3 feet)	0.9144 metre
1 (statute) mile (=1760 yards)	1.6093 kilometres
1 (nautical) mile (=1.150779 miles)	1.852 kilometres

SQUARE MEASURE (AREA)

IMPERIAL	METRIC
1 square inch	6.4516 sq. centimeters
1 square foot (=144 square inches)	9.29 square decimeters
1 square yard (=9 square feet)	0.8361 square metres
1 acre (=4840 square yards)	0.40469 hectare
1 square mile (=640 acres)	259 hectares

CUBIC MEASURE (VOLUME)

IMPERIAL	METRIC
1 cubic inch	16.4 cubic centimeters
1 cubic foot (=1728 cubic inches)	0.0283 cubic metres
1 cubic yard (=27 cubic feet)	0.765 cubic metres

CAPACITY MEASURE (VOLUME)

IMPERIAL	METRIC
1 (imperial) fl. oz. (=1/20 imperial pint)	28.41 ml
1 (US liquid) fl. oz. (=1/16 US pint)	29.57 ml
1 (imperial) gill (=1/4 imperial pint)	142.07 ml
1 (US liquid) gill (=1/4 US pint)	118.29 ml
1 (imperial) pint (=20 fl. imperial oz.)	568.26 ml
1 (US liquid) pint (=16 fl. US oz.)	473.18 ml
1 (US dry) pint (=1/2 quart)	550.61 ml
1 (imperial) gallon (=4 quarts)	4.546 litres
1 (US liquid) gallon (=4 quarts)	3.785 litres
1 (imperial) peck (=2 gallons)	9.092 litres
1 (US dry) peck (=8 quarts)	8.810 litres
1 (imperial) bushel (=4 pecks)	36.369 litres
1 (US dry) bushel (=4 pecks)	35.239 litres

MASS (WEIGHT)

IMPERIAL	METRIC
1 grain	0.065 gram
1 dram	1.772 grams
1 ounce (=16 drams)	28.35 grams
1 pound (=16 ounces =7000 grains)	0.45359237 kilogram
1 stone (=14 pounds)	6.35 kilograms
1 quarter (=2 stones)	12.70 kilograms
1 hundredweight (=4 quarters =112 lb.)	50.80 kilograms
1 (long) ton (=2240 lbs)	1.016 tonnes
1 (short) ton (=2,000 lbs)	0.907 tonne

METRIC

IMPERIAL

LINEAR MEASURE (LENGTH/DISTANCE)

METRIC	IMPERIAL
1 millimetre	0.0394 inch
1 centimetre (=10 mm)	0.3937 inch
1 decimetre (=10 cm)	3.937 inches
1 metre (=100 cm)	1.0936 yards
1 decametre (=10 m)	10.936 yards
1 hectometre (=100 m)	109.36 yards
1 kilometre (=1000 m)	0.6214 miles

SQUARE MEASURE (AREA)

METRIC	IMPERIAL
1 square centimetre	0.1550 sq. inch
1 square metre (=10 000 sq. cm)	1.1960 sq. yards
1 are (=100 sq. metres)	119.60 sq. yards
1 hectare (=100 ares)	2.4711 acres
1 square kilometre (=100 hectares)	0.3861 sq. mile

CUBIC MEASURE (VOLUME)

METRIC	IMPERIAL
1 cubic centimeter	0.0610 cubic inch
1 cubic metre (one million cu. cm)	1.308 cubic yards

CAPACITY MEASURE (VOLUME)

METRIC	IMPERIAL
1 millilitre	0.002 (imperial) pint
1 centilitre (=10 ml)	0.018 pint
1 decilitre (=100 ml)	0.176 pint
1 litre (=1000 ml)	1.76 pints
1 decalitre (=10 l)	2.20 (imperial) gallons
1 hectolitre (=100 l)	2.75 (imperial) bushels

MASS (WEIGHT)

METRIC	IMPERIAL
1 milligram	0.015 grain
1 centigram (=10 mg)	0.154 grain
1 decigram (=100 mg)	1.543 grain
1 gram (=1000 mg)	15.43 grain
1 decagram (=10 g)	5.64 drams
1 hectogram (=100 g)	3.527 ounces
1 kilogram (=1000 g)	2.205 pounds
1 tonne (=1000 kg)	0.984 (long) ton

Celsius to Fahrenheit Conversion Chart¹

°C	°F	°C	°F	°C	°F	°C	°F
50	122.0	27	80.6	4	39.2	-19	-2.2
49	120.2	26	78.8	3	37.4	-20	-4.0
48	118.4	25	77.0	2	35.6	-21	-5.8
47	116.6	24	75.2	1	33.8	-22	-7.6
46	114.8	23	73.4	0	32.0	-23	-9.4
45	113.0	22	71.6	-1	30.2	-24	-11.2
44	111.2	21	69.8	-2	28.4	-25	-13.0
43	109.4	20	68.0	-3	26.6	-26	-14.8
42	107.6	19	66.2	-4	24.8	-27	-16.6
41	105.8	18	64.4	-5	23.0	-28	-18.4
40	104.0	17	62.6	-6	21.2	-29	-20.2
39	102.2	16	60.8	-7	19.4	-30	-22.0
38	100.4	15	59.0	-8	17.6	-31	-23.8
37	98.6	14	57.2	-9	15.8	-32	-25.6
36	96.8	13	55.4	-10	14.0	-33	-27.4
35	95.0	12	53.6	-11	12.2	-34	-29.2
34	93.2	11	51.8	-12	10.4	-35	-31.0
33	91.4	10	50.0	-13	8.6	-36	-32.8
32	89.6	9	48.2	-14	6.8	-37	-34.6
31	87.8	8	46.4	-15	5.0	-38	-36.4
30	86.0	7	44.6	-16	3.2	-39	-38.2
29	84.2	6	42.8	-17	1.4	-40	-40.0
28	82.4	5	41.0	-18	-0.4	-	-

Economics:

US Dollars (USD/\$): <https://www.x-rates.com/table/?from=USD&amount=1>

Euros (EUR/€): <https://www.x-rates.com/table/?from=EUR&amount=1>

Bitcoin (BTC/ ₿): https://www.binance.com/en/trade/BTC_USDT

Monero (XMR): https://www.binance.com/en/trade/XMR_USDT

Introduction

The Last Resort is a compilation of texts with the expressed purpose of giving hints to anyone who seeks to maximize carnage on the status quo. Most other documents or compendiums of this kind are flawed, and The Last Resort attempts to make the most comprehensive body of knowledge relating to these sorts of texts. However, this document does not subscribe to any particular flavor of extremism. For this reason, the documents compiled have been edited to strip them of their political agenda; whether the source was jihadist, communist, fascist, or whatever. The instructions that are taken from these documents will also be edited, so see original sources if needed.

This compilation will contains instructions on how to manufacture explosives, firearms, and ammunition, guides for combat and guerrilla warfare, as well as guides for survival in the wilderness. It is highly likely that accessing this compilation in certain regions can be punished by law. It is thus highly advised to save this document with encryption or to access it online with Tor or an I2P bridge.

The recipes and instructions in this compilation are capable of severe damage to property and injury to person. It is highly advised be familiar with the recipes and instructions before attempting to carry them out. Misuse could lead to the injury or death of the reader. The reader should know the legal implications of the execution of the instructions contained within this document.

It is encouraged to distribute this compilation on the internet. This is especially the case if after or just before the execution of a successful attack. Distributors may not edit the original form of this compilation as to save its integrity and approachability, but they may attach other ideological documents separately.

The document may be split into separate parts and chapters excluded only if printed as to save space on the storage and to save paper. Paragraphs and sections may be posted on the internet as text messages or posts with credit to the original document. These guidelines are not enforced but should be followed for the reasons mentioned in the previous paragraph.

The author and compiler of this document is anonymous and will remain as such. I fully endorse the usage and or dissemination of the information given in this compilation and approve of any attempts to emulate the information given regardless of motive.

Unlike the earlier version this release will not have sources for every claim. The earlier version can be found here:

- <https://gofile.io/d/Y9tllt>
- https://anonfiles.com/382ea6X8u9/The_Last_Resort_pdf
- <https://archive.org/details/the-last-resort>
- <http://mbv5a7cc6756lkpqts6si5zcpwxvd43cyb4atbqzjgypktsdofthphyqd.onion/.media/67d203a4412dced3de0e3700e689963d023efc4c5edda3b5e820cecd8b7f7a8a.pdf>

CHAPTER I: BEFORE OPERATIONS

Preparing For The Operation

Note: This section was largely written by Anders Behring Breivik.

There are several things that should be done by the guerrilla before starting the process of planning and taking up armed struggle.

The first of which is to surround yourself (either online or in real life) with people who support your political ideology but who at the same time does not jeopardize your security in any way. You should therefore avoid any affiliations with known extremists or such groups as they are most likely flagged (individuals and groups who are monitored by your national intelligence agency on so called "watch lists"). The reason why you should surround yourself with "moderate sympathizers" is because you will need a minimum of moral support.

The second is to prepare to leave everyone else you know behind and prepare for a lonely, poor and potentially painful existence of hardship and uncertainty. As a guerrilla, you are a part of an indestructible network of cells, spread all around the world that functions without a central command.

The initial advantages of clandestine cells are:

1. We take the enemy by surprise.
2. We know the terrain of the encounter.
3. We have greater mobility and speed than the police.
4. We are in command of the situation, and demonstrate great decisiveness, which on the other hand will result in our enemy being stunned and incapable of acting.
5. We are prepared to die in order to complete our objectives.

The technique of surprise is based upon four essential requirements:

- a. We know the situation of the enemy we are going to attack, usually by means of precise information and meticulous observation, while the enemy does not know he is going to be attacked and knows nothing about us.
- b. We know the strength of the enemy we are going to attack, and the enemy knows nothing about our strength.
- c. We attack by surprise in single cells, independent of any hierarchical structure and are therefore saving and conserving our forces, while our enemy is unable to do the same, and is left at the mercy of events.
- d. We determine the time and place of the attack, decide its duration and establish its objectives. Our enemy remains ignorant of all of this information.

The guerrilla must dedicate all his efforts in order to be completely prepared before carrying out actions, for in this he cannot commit the slightest error. Any carelessness in research and learning tactics and their use invites certain disaster, as experience teaches us every day. Common criminals commit errors frequently because of their lack of tactics.

The revolutionary method of carrying out actions is strongly and forcefully based on the knowledge and use of the following elements;

1. Financing your operation.
2. Safe research and intelligence gathering.
3. Acquisition of weapons, body armor and other equipment.
4. Transportation (having a car/scooter available or rely on expropriation).
5. Safe storage in remote caches (The elimination of evidence).
6. Reconnaissance or exploration of the terrain.
7. Study and timing of routes.
8. Simulate the operation again and again (study and practice).
9. Success.

Certain individuals will already have enough capital to fund an operation. 10 000–20 000 Euro would be sufficient for assassinations/executions of key enemies. The range of funds needed varies from 10 000 - 200 000 Euro (depending on the nature of the operation). Here are a few guidelines if you are completely broke or even indebted:

12 months of hard work (sales and marketing) would allow you to save approximately 30 000-50 000 Euro in many Western European countries. Furthermore, you will be able to apply for various credit and loan arrangements (credit cards or other long term/short term credit solutions) netting you from 20 000-100 000 Euro. This should be sufficient for any low to medium scale operation. Keep in mind that additional funds would give you more leeway and allow for more operational flexibility.

If criminal activities is the only available option for you, know this; It is politically and strategically justifiable to "expropriate" resources if it finances the armed struggle. This the primary factor that separates urban guerrillas from common criminals. Criminals rob for their own benefit while guerrillas expropriate in order to serve their cause.

The Black Market

Travel to any major city. If you are a French citizen for example, keep in mind that you want to avoid any interaction with groups in your own city as your local police force might be able to identify you and cross reference you with watch lists. Your national police force has many informants among criminal networks so avoid your own country as base for acquiring equipment. You might consider avoiding your neighboring country as well (depending on your country of origin of course) as individuals can identify your nationality or identity. If your nationality is uncovered and the information passed on to the local police department, they can risk being identified (by using customs info/air line etc). If possible, purchase a fake id (passport, bank ID or drivers license) in your own country and use it if you need to deceive anyone abroad. Never carry both id's on you at the same time (during any arms transaction). Never travel byplane. Rent a car in your country and drive to your destination.

Approach criminal networks cautiously and try to locate a local black market arms dealer. Present yourself as a gun collector. You might want to use a middle man/straw man for the actual transaction (a local drug dealer or any suitable individual and compensate him with a fixed or percentage based fee). Attempt to complete a "test transaction", in order to verify your intermediary's level of trust. Be prepared for the worst, do not carry large cash amounts (many will have nothing to offer and will try to rob, scam you). Do not reveal your

political convictions. The criminals you are buying from could be white supremacist skinheads who would not take kindly to Communists, or Muslims and Latinos who would not take kindly to neo-Fascists.

Make for example 4 separate transactions:

1. Glock 17 + silencer.
2. Assault rifle.
3. Special ammo (armour penetration or hollow-point).
4. Splint grenades/shock grenades.

Diversify risk by dividing the operation into 4 phases

1. Research phase. Storing certain information electronically in shorter or longer periods is unavoidable during the research phase (logistical strategies and bomb/weapon schematics etc). This information is usually stored on the individuals PC while doing research. Keep in mind that the planning of military operations/attacks (under terrorism laws) is illegal. A schematic or vague indications of a plan are not considered solid evidence unless backed by either witness testimony or either weapons or explosive components together with verifiable affiliations to terror groups.

2. Logistics. Before you start the logistics phase you need to store all relevant research/information on a memory stick and get rid of it (bury it in a moist proof sealed container far away from your home or completely encrypt it, you will acquire it again in phase 3). The reason is that any written plans combined with weapons or explosives are considered solid evidence. Also, you need to clear your PC hard drive. Deleting the information is not sufficient. You need physically destroy it, submerge it in liquid and dump it on the other side of town, or use Bleachbit. You are now set to start the logistics phase. Acquire the necessary weapons, ammo, body armor and explosives. As the "shopping phase" can last up to 12 months you should divide the total list into 4 batches. As soon as you have bought 25 or 33% of the list, seal it in a container and bury far from your home/base. Find separate locations for the next caches. The essence is to avoid having weapons/armor (evidence) in your base/home as it will incriminate you.

3. Assembly phase. Before you start this phase, you should keep in mind that phase 4 will be executed shortly after assembly. You should therefore ensure that you have completed all practical assignments (or private issues) before you start phase 3. This is the most risky phase. You are vulnerable as you will have all the equipment (evidence) you have acquired readily available. Ensure that the assembly phase does not last longer than it should (7 days maximum).

4. Implementation/execution of operation. Assembly phase completed. You are now ready to start on your mission. Good luck and give them hell!

7 deadly mistakes to be avoided

1. Use single or duo cell system. Several larger hierarchical networks/groups have been uncovered and brought down in both Europe and the US due to crucial mistakes that could easily have been avoided. Typical mistakes can be affiliations with individuals on government watch-lists, if you add the people from your group on Facebook etc. If you even as much as give indications that you are up to something to people you know, you

are incriminating them (and thus, indirectly putting pressure on them to turn you in). A few years ago a large military nationalist network was brought down in the US (consisting of around 100 people). There was clear evidence that the individuals were linked (evidence from informants, phone logs etc) and they all received harsh sentences. The most rational approach would have been to create 50-100 cells and cutting contact with each other completely (12-24 months prior to the assaults). Instead this group worked as one big cell which made them very vulnerable. One key informant could bring down the whole network. Obviously, you are immune to informants/treason if you work alone.

2. The second mistake is inexperience. Assuming the enemy is stupid, underestimates the enemy's intelligence, thinks everything is easy and, as a result, leaves evidence that can lead to his apprehension. Because of his inexperience, he may also overestimate the resourcefulness of the enemy, believing them to be smarter than they really are. Allowing himself to be fooled by this presumption, he becomes intimidated and remains insecure and indecisive, paralyzed and lacking in audacity.

3. The third mistake is to select an overwhelmingly protected individual as a target for assassination. 12 failed attempts on an extremely well protected individual could have alternatively been 12 successful attacks on lesser targets executing more than 50 primary targets. Targets should still be influential. Obviously, focus on individuals who does not have armed body guards.

4. The fourth mistake is to boast about the actions you have undertaken or is about to undertake and to broadcast them to the four winds. It is good to have a strong sense of purpose but if you are afflicted by an excessive need to feed your ego, you are likely to trust sensitive information to individuals who will sell you out. If you are desperate for attention and for "love/appreciation/compliments" you are likely to take unnecessary risks that will end in your incarceration. Do not involve your ego by boasting about your success, operation or entering into a "competition" with other people. As a guerrilla, you are strictly prohibited from disclosing sensitive information to outsiders (whether they may sympathize with your core principles or not). I estimate that approximately 50% of all armed guerrillas in the west are arrested and incarcerated before they even get the chance to execute their mission due to their incompetence in relation to their total lack of discretion.

5. The fifth mistake is to overestimate your partners strength/conviction and to undertake actions for which you, as yet, lack sufficient equipment or competence.

6. The sixth mistake is rash action. You lose patience, suffer an attack of nerves, do not wait for anything, and impetuously throw yourself into action, resulting in a failed operation.

7. The seventh mistake is to fail to plan things THOROUGHLY, and to act spontaneously.

Characteristics Of The Urban Guerrilla

Note: This section was largely written by Carlos Marighella.

The urban guerrilla is a person who fights the military dictatorship with weapons, using unconventional methods. A revolutionary and an ardent patriot, he is a fighter for his country's liberation, a friend of the people and of freedom. The area in which the urban

guerrilla operates in the large cities. There are also criminals or outlaws who work in the big cities. Many times, actions by criminals are taken to be actions by urban guerrillas.

The urban guerrilla, however, differs radically from the criminal. The criminal benefits personally from his actions, and attacks indiscriminately without distinguishing between the exploiters and the exploited, which is why there are so many ordinary people among his victims. The urban guerrilla follows a political goal, and only attacks the government, the big businesses and the foreign imperialists.

Another element just as harmful to the guerrillas as the criminal, and also operating in the urban area, is the counterrevolutionary, who creates confusion, robs banks, throws bombs, kidnaps, assassinates, and commits the worst crimes imaginable against urban guerrillas, revolutionary priests, students, and citizens who oppose tyranny and seek liberty.

The urban guerrilla is an implacable enemy of the regime, and systematically inflicts damage on the authorities and on the people who dominate the country and exercise power. The primary task of the urban guerrilla is to distract, to wear down, to demoralize the military regime and its repressive forces, and also to attack and destroy the wealth and property of the foreign managers and the region's status quo.

The urban guerrilla is not afraid to dismantle and destroy the present economic, political and social system, for his aim is to aid the rural guerrillas and to help in the creation of a totally new and revolutionary social and political structure, with the armed population in power.

The urban guerrilla is characterized by his bravery and his decisive nature. He must be a good tactician, and a good marksman. The urban guerrilla must be a person of great cleverness to compensate for the fact that he is not sufficiently strong in weapons, ammunition and equipment.

The career military officers and the government police have modern weapons and transport, and can go about anywhere freely, using the force of their own strength. The urban guerrilla does not have such resources at his disposal, and leads a clandestine existence. The guerrilla may be a convicted person or one who is out on parole, and must then use false documents if possible.

Nevertheless, the urban guerrilla has an advantage over the conventional military or the police. It is that, while the military and the police act on behalf of the enemy, whom the people hate, the urban guerrilla defends a just cause, which is the people's cause.

The urban guerrilla's weapons are inferior to the enemy's, but from the moral point of view, the urban guerrilla has an undeniable superiority. This moral superiority is what sustains the urban guerrilla. Thanks to it, the urban guerrilla can accomplish his principle duty, which is to attack and survive.

The urban guerrilla has to capture or steal weapons from the enemy to be able to fight. Because his weapons are not uniform—since what he has are expropriated or have fallen into his hands in various ways—the urban guerrilla faces the problem of a variety of weapons and a shortage of ammunition. Moreover, he has no place in which to practice shooting and marksmanship. These difficulties have to be overcome, forcing the urban

guerrillas to be imaginative and creative—qualities without which it would be impossible for him to carry out his role as a revolutionary.

The urban guerrilla must possess initiative, mobility and flexibility, as well as versatility and a command of any situation. Initiative especially is an indispensable quality. It is not always possible to foresee everything, and the urban guerrilla cannot let himself become confused, or wait for instructions. His duty is to act, to find adequate solutions for each problem he faces, and to retreat. It is better to err acting than to do nothing for fear of making a mistake. Without initiative, there is no urban guerrilla warfare.

Other important qualities in the urban guerrilla are the following: to be a good walker, to be able to stand up against fatigue, hunger, rain or heat. To know how to hide, and how to be vigilant. To conquer the art of dissembling. Never to fear danger. To behave the same by day as by night. Not to act impetuously. To have unlimited patience. To remain calm and cool in the worst of conditions and situations. Never to leave a track or trail. Not to get discouraged.

In the face of the almost insurmountable difficulties in urban guerrilla warfare, sometimes comrades weaken and give up the fight.

The urban guerrilla is not a businessman in an urban company, nor is he an actor in a play. Urban guerrilla warfare, like rural guerrilla warfare, is a pledge which the guerrilla makes to himself. When he can no longer face the difficulties, or if he knows that he lacks the patience to wait, then it is better for him to relinquish his role before he betrays his pledge, for he clearly lacks the basic qualities necessary to be a guerrilla.

The urban guerrilla must know how to live among the people, and he must be careful not to appear strange and different from ordinary city life. He should not wear clothes that are different from those that other people wear. Elaborate and high-fashion clothing for men or women may often be a handicap if the urban guerrilla's mission takes him into working class neighborhoods, or sections where such dress is uncommon. The same care has to be taken if the urban guerrilla must move from the South of the country to the North, and vice versa.

The urban guerrilla must make his living through his job or his professional activity. If he is known and sought by the police, he must go underground, and sometimes must live hidden. Under such circumstances, the urban guerrilla cannot reveal his activity to anyone, since this information is always and only the responsibility of the revolutionary organization in which he is participating.

The urban guerrilla must have a great ability for observation. He must be well-informed about everything, particularly about the enemy's movements, and he must be very inquisitive and knowledgeable about the area in which he lives, operates, or travels through.

But the fundamental characteristic of the urban guerrilla is that he is a man who fights with weapons; given these circumstances, there is very little likelihood that he will be able to follow his normal profession for long without being identified by the police. The role of expropriation thus looms as clear as high noon. It is impossible for the urban guerrilla to exist and survive without fighting to expropriate.

Thus, the armed struggle of the urban guerrilla points towards two essential objectives:

1. the physical elimination of the leaders and assistants of the armed forces and of the police;
 2. the expropriation of government resources and the wealth belonging to the enemy, with small expropriations used for the sustenance of the individual guerrillas and large ones for the maintenance of the revolutionary organization itself.
- It is clear that the armed struggle of the urban guerrilla also has other objectives. But here we are referring to the two basic objectives, above all expropriation. It is necessary for every urban guerrilla to always keep in mind that he can only maintain his existence if he is able to kill the police and those dedicated to repression, and if he is determined—truly determined—to expropriate the wealth of the rich enemies.

Technical preparation

No one can become an urban guerrilla without paying special attention to technical preparation. The technical preparation of the urban guerrilla runs from a concern for his physical condition to a knowledge of and apprenticeship in professions and skills of all kinds, particularly manual skills.

The urban guerrilla can have a strong physical constitution only if he trains systematically. He cannot be a good fighter if he has not learned the art of fighting. For that reason, the urban guerrilla must learn and practice the various forms of unarmed fighting, of attack, and of personal defense. Other useful forms of physical preparation are hiking, camping, the practice of survival in the woods, mountain climbing, rowing, swimming, skin diving and training as a frogman, fishing, harpooning, and the hunting of birds and of small and big game.

A knowledge of various types of ammunition and explosives is another aspect to consider. The use of incendiary bombs, smoke bombs, and other types is also indispensable prior training. To know how to improvise and repair weapons, prepare Molotov cocktails, grenades, mines, homemade destructive devices, how to blow up bridges, tear up and put out of service railroads and railroad cars, these are necessities in the technical preparation of the urban guerrilla that can never be considered unimportant.

The shot: the urban guerrilla's reason for existence, the basic condition in which he acts and survives, is to shoot. The urban guerrilla must know how to shoot well, because it is required by this type of combat.

In conventional warfare, combat is generally at a distance with long-range weapons. In unconventional warfare, in which urban guerrilla warfare is included, combat is at short range and often very close. To prevent his own death, the urban guerrilla must shoot first, and he cannot err in his shot. He cannot waste his ammunition because he does not possess large amounts, and so he must conserve it. Nor can he replace his ammunition quickly, since he is a part of a small team in which each guerrilla has to be able to look after himself. The urban guerrilla can lose no time, and thus has to be able to shoot at once.

One basic fact, which we want to emphasize completely, and whose importance cannot be overestimated, is that the urban guerrilla must not fire continuously, using up his ammunition. It may be that the enemy is responding to this fire precisely because he is waiting until the guerrilla's ammunition is all used up. At such a moment, without having the opportunity to replace his ammunition, the guerrilla faces a rain of enemy fire, and can be taken prisoner or killed.

In spite of the value of the surprise factor, which many times makes it unnecessary for the urban guerrilla to use his weapons, he cannot be allowed the luxury of entering combat without knowing how to shoot. And when face-to-face with the enemy, he must always be moving from one position to another, since to stay in one place makes him a fixed target and, as such, very vulnerable.

The urban guerrilla's life depends on shooting, on his ability to handle his weapons well and to avoid being hit. When we speak of shooting, we speak of accuracy as well. Shooting must be practiced until it becomes a reflex action on the part of the urban guerrilla. To learn how to shoot and have good aim, the urban guerrilla must train himself systematically, utilizing every practice method shooting at targets, even in amusement parks and at home.

Shooting and marksmanship are the urban guerrilla's water and air. His perfection of the art of shooting may make him a special type of urban guerrilla—that is, a sniper, a category of solitary combatant indispensable in isolated actions. The sniper knows how to shoot at close range and at long range, and his weapons are appropriate for either type of shooting.

Sometimes the urban guerrilla may have to organize in groups when carrying out an operation.

A team of no more than four or five is called a firing group. A minimum of two firing groups, separated and insulated from other firing groups, directed and coordinated by one or two persons, this is what makes a firing team.

Within the firing group, there must be complete confidence among the members. The best shot, the one who knows best how to handle the weapon of choice, and the one who is a good leader is the person in charge of operations.

The firing group plans and executes urban guerrilla actions, obtains and stores weapons, and studies and corrects its own tactics.

When there are tasks planned by the strategic command, these tasks take preference. But there is no such thing as a firing group without its own initiative. For this reason, it is essential to avoid any rigidity in the guerrilla organization, in order to permit the greatest possible initiative on the part of the firing group. The old-type hierarchy, the style of the traditional revolutionaries, doesn't exist in our organization. This means that, except for the priority of the objectives set by the strategic command, any firing group can decide to raid a bank, to kidnap or execute an agent of the status quo, a figure identified with the reaction, or a foreign spy, and can carry out any type of propaganda or war of nerves against the enemy, without the need to consult with the general command.

No firing group can remain inactive waiting for orders from above. Its obligation is to act. Any single urban guerrilla who wants to establish a firing group and begin action can do so, and thus becomes a part of the organization.

This method of action eliminates the need for knowing who is carrying out which actions, since there is free initiative and the only important point is to greatly increase the volume of urban guerrilla activity in order to wear out the government and force it onto the defensive.

The firing group is the instrument of organized action. Within it, guerrilla operations and tactics are planned, launched and carried through to success. The general command counts on the firing groups to carry out objectives of a strategic nature, and to do so in any part of the country. For its part, the general command helps the firing groups with their difficulties and with carrying out objectives of a strategic nature, and to do so in any part of the country.

The organization is an indestructible network of firing groups, and of coordinations among them, that functions simply and practically within a general command that also participates in attacks—an organization that exists for no other purpose than that of pure and simple revolutionary action.

Lifestyle Recommendations

Before the guerrilla can defeat the enemy, he must first defeat the enemy within himself. Doing so will make the guerrilla an even more powerful force when carrying out the operation.

The guerrilla should eat 3 or 4 times a day with little or nothing in between and may fast in a simple 18/6 routine to build discipline. Eat healthy food if possible; no fast food, no candy (although high cocoa dark chocolate is acceptable), and no snacks. It is acceptable for the items mentioned to be eaten in celebration or if there is nothing else. They should also avoid consuming alcoholic beverages (which may worsen their performance or give them hangover the next day) and caffeine (which will over time make the drinker more dependent on it). Nutritional vegetables, meat, fish, and fruits. Research how many carbs, proteins, fats, and vitamins are in the foods you eat and do not overeat unless to gain bulk for bodybuilding.

Go to the gym or start a body weight routine. Having supportive friends at the gym can help to build motivation. Motivation will not last forever however, and must be solidified into discipline through hard work. Do not neglect cardio, go for a morning run. Take a cold shower if needed. Get 7-9 hours of good quality sleep every night, avoid stimulants in the late afternoon. Become a morning person and get up early. The guerrilla should ideally weigh anywhere from 70 kg to 95 kg (depending on their height) and should not be underweight or obese. Being overweight can be acceptable.

If you know what you are doing, taking anabolic steroids could help in becoming stronger. Beware of any side effects after long term use. It is advised for those sent on suicide missions to take anabolic steroids.

Avoid destructive habits such as overeating, wasting yourself on alcohol, smoking, consuming drugs, having sex with prostitutes, and excessively watching pornography

(read this for help: <https://easypeasymethod.org/>) or other garbage produced for consumerists who sit around all day. This is especially the case just before carrying out an operation. The guerrilla must be resilient during the mission. Pick up other better habits instead, such as reading books, philosophizing, and developing better plans. If frustration builds up, the gym can cool you down. Exercise takes out frustration and strengthens the guerrilla.

The terrorist must develop “one-point concentration.” Do not be overburdened by many conflicts. Execute each conflict by each conflict. Do not be hopeless about the “long road.” Think of the now. Do not be destroyed by losing to primal urges. Get back up and continue the process of ascension. The runner does not stop running when they stumble. The runner stands up after falling and continues running. Do what is right. Not what is easy.

During the operation: Are you ready to hold an ideal and or virtue so strongly that you are willing to suffer yourself for it? Are you even ready to spill your own blood and die for it? There is a high probability of you being killed in action, being imprisoned for many years or life and punished in other cruel manners as a guerrilla. You will also have to consider the actions you perpetrated for the rest of your life if you survive. The guerrilla must have a resilient mindset during the operation. Remember: Who, if not you? When, if not now? Show the status quo exactly what you think of them. Not by words. By knife. By bullet. By bomb. Only die after you have done your best.

How to stay motivated for longer periods

Note: This section was largely written by Anders Behring Breivik.

Being against the status quo is not for everyone. You are normally required to plan absolutely everything alone; fight alone to see your mission through and you are likely to die alone with half of your city’s system protectors hunting you. However, I have never in my life felt that I have done anything more meaningful than what I am doing now regardless of the lack of moral support from my founding brothers or other guerrillas. Support from our extremely distributed and anonymous “non-hierarchy” out there would be nice but I have managed to cope through mental discipline to become what I am today; a self driven and highly effective manifestation of an independent cell. I have managed to stay focused and highly motivated for a duration of more than 9 years now. I feel really happy about my current course. In fact, I have never been happier than I am today and I do not find it problematical hide my true ideological agenda from everyone else. To all I know I am a moderate right-winger and not a resistance fighter. It isn’t easy to reach this level of mental comfort and focus while at the same time working on something so important and serious. You have to overcome difficult initial psychological challenges and perform a slight subsequent mental check every single day until the operation is complete. This shouldn’t be underestimated as it is perhaps the most important aspect of being a part of an cell network where you rely on being able to motivate yourself. Embracing martyrdom is not something you suddenly decide to do, but it is a process that takes time and requires effort and self contemplation. This is a factor that a majority of resistance fighters ignore and is why a majority of novices become demotivated after a certain period. They are not doing what is required of them due to lack of training, knowledge and eventually lose the will to fight due to lack of motivation. I do a mental check almost every day through meditation and philosophizing. I simulate/meditate while I go for a walk,

playing my iPod in my neighborhood. This consists of a daily 40 minute walk while at the same time philosophizing ideologically/performing self indoctrination and the mental simulation of the operation while listening to motivational and inspiring music. I simulate various future scenarios relating to resistance efforts, confrontations with police, future interrogation scenarios, future court appearances, future media interviews etc. or I philosophize about certain articles in the book. This daily mental exercise or ritual keeps me fully motivated and charges my batteries. And I'm sure it can work for other people as well.

Learning the ability/rituals to motivate yourself and being able to follow this ritual on a daily basis is perhaps the most essential aspect of our armed resistance effort. One of the reasons why Muslims are so effective at guerrilla warfare is that they keep themselves motivated by praying five times a day and reciting motivational Suras from the Quran. Even the irreligious guerrilla must find motivation in ritual behavior.

Certain measures can and should be taken to balance/revitalize your psychological state of mind in situations when you feel completely demotivated and down during the various planning phases. At the end of the day; you are your own worst enemy, and demotivation leading to psychological breakdown and eventually to a scenario where a resistance fighter chooses to abandon the ideological cause is one of the most recurrent causes for individuals who lacks competence in revitalizing and balancing his psychological state of mind. It is absolutely essential that you learn and practice efficient rituals and various methods to maintain high moral and motivation. It is permitted and even encouraged that you seek whatever solutions that works for you including enjoying good food, sexual stimuli with a loved one, meditation and any and all methods that will contribute to keep your moral and motivation up.

These methods are considered as a quite efficient psychological stimulus which has the potency to boost your serotonin production and help you overcome any situation where you feel drained, scared, insecure, confused or demotivated. As overcoming continuous and often daily personal psychological barriers is at the very core of our challenges, using these tactical psychological methods and similar approaches should be considered an integral part of the planning phases to ensure that you remain in a balanced state of mind. A balanced state of mind (especially for single or duo cells) is required for any military operation which last over a longer period. You may be prevented from communicating and receiving a much needed "pat on the back" or encouraging comments from other cell members as you may be in a single or duo cell, relying on your own self-encouraging measures. Ensuring that you maintain a stable, motivated and focused mind is anything but absurd. Yes, for certain religious members, certain measures are obviously in violation to their religion's teachings but the amount of grace and divine goodwill generated at the point where you sacrifice everything (in the martyrdom operation) will provide you with an abundance of it, which will more than nullify any minor or serious sins committed prior to operation.

Becoming and maintaining the position as a self sufficient resistance sleeper cell involves the capability to motivate/indoctrinate yourself over a prolonged period of time. Self-financed and self-indoctrinated single individual attack cells, is the backbone of the movement against the status quo. The importance of the ability for single cell commanders to be able to keep their spirits and morale up through self-indoctrination and motivation by using specific motivational techniques has been stressed on multiple occasions.

I have previously stated that taking long walks/work out while listening to select music is a very efficient way of sustaining your needs in this regard. 3-5, 40-90 min walks/workouts per week has sustained my high morale, confidence and motivation for several years. When you combine this "ritual" with reading the occasional resistance blog you gain all the motivation you will ever need. Repeat these routines on a weekly basis and you will sustain your motivation and moral for as long as is needed. Keep in mind that from the initial planning of your operation to the actual effectuation of it, the time passed can exceed 2 years. The key to stay focused and motivated without taking the unacceptable risk of communicating with other revolutionaries, is to employ successful motivational techniques on your own.

Avoiding Suspicion

Note: This section was largely written by Anders Behring Breivik.

Present a "credible project/alibi" to your friends, co-workers and family. Announce to your closest friends, co-workers and family that you are pursuing a "project" that can at least partly justify your "new pattern of activities" (isolation/travel) while in the planning phase.

Some good cover stories may be growing a strong interest in online gaming, writing a book, programming, fishing, hunting, and many other activities done alone. Activities that will justify somewhat why you are not answering your phone over long periods.

Using social taboos is an extremely effective method from preventing people who know you well from digging too much or ask too many questions about your activities that weekend or that year. It is also an extremely effective method for manipulating them into protecting your cover. It is shameful to be addicted to gaming or to be an active homosexual, and tell people that you yourself are ashamed of it and you don't want to talk any more about it. Make them swear to not tell anyone! You will have a cover story for being alone.

Avoid exposing your political conviction. Appear politically correct or at least moderate, dress normally. Try to limit your rhetorical activities. Avoid excessive forum posting. Excessive forum activity might get you "flagged" by your national government. These are all cynical and manipulative strategies but extremely effective. Lying to and manipulating other people is generally a bad thing and should be avoided if possible. However, the severity of our operation often requires us to be cynical, manipulative and pragmatical. We don't have to like it, but we occasionally have to do it.

Acquiring Firearms In France

Taken from a guide written here:

https://amagicalplace.fandom.com/wiki/Sticky#How_to_get_guns_when_you_are_a_baguette_.28French.27s_law.29

France is very draconian when it comes to laws regarding weapons. You do not even have the right to carry pepper spray in your bag! That's not a joke! So, if you don't want to desert

during the ever-encroaching civil war, here is how to do so. For readers in regions with similarly strict laws, see the website linked below page for the specific laws where you live. The laws could be even stricter or slightly lighter. Just remember that in most regions, you need a medical certificate for getting a license.

Learn more about your region's gun laws: <https://www.gunpolicy.org/firearms/region/>

Category D: Free access for 18+ individuals. You need no license for these. The most powerful thing you can buy and carry (only at home) is a black powder weapon made before 1900. These are most often in .44 or .36 (this one is better for penetration) caliber. One of the best guns you can buy is a Remington 1858 with maybe a .36 caliber and ogival paper-made cartridge. The worse issue is that black powder doesn't come with ammunition, you need to make it yourself. You take black powder, light paper for smoking and a fire-making component (amorçe). You can have the lower price for 300€, do not buy the "laiton" case, it's too weak, buy the steel one!

Category C & B: Try to act normally when visiting the medic. If you want a "real" gun, you will need to get a license. Some licenses have additional meaning to them. For example, getting a hunting license and then never hunting or getting a shooting license and then never attending the range may have the license taken away from you. Just spend some extra off time on those activities.

- 60€: Ball-trap license (cat. C)
- 50€+100€: Hunting license (cat. C)
- 200€: Shooting license (cat. C + B)

Category C: you have the following calibers only in bolt-action: .22LR, .222, .308 Winchester, 30-06 Springfield, and the most powerful one, .338 Lapua. Do not forget that it's only bolt-action and a maximum 9-rounds + 1 cartridge holder! The most interesting thing on category C: the shotgun! Actually it's not a real shotgun because the barrel is made like a carbine (it's rifled). Here are some good 'shotguns': Remington 870 Express, Mossberg Maverick 88, and Fabarm STF12 (but it's really pricey ~1300€).

Category B: It is the beginning of serious stuff here. The stuff that could get you armed to the teeth. So here, you can get handguns in 9mm, .45 ACP, .357 Magnum, and all that stuff. You can get a semi-automatic rifle, 7.62x39 and 5.56, all those "war calibers".

Laboratory

Note: This section was largely written by Anders Behring Breivik.

You can probably survive using kitchen ware but considering the low cost of laboratory glass ware, I really recommend investing in the following items. The primary reason is because laboratory grade glassware is specifically designed for heating, while kitchen glass ware may break if heated directly on a hot plate with potentially fatal consequences. DO NOT under any circumstances use an open flame heater. Always use an electrical heater, preferably a hot plate stirrer. A majority of accidents relating to explosives involves open flames or individuals dropping explosive materials on the floor so be careful.

Many individuals make the mistake of using their urban apartment as a lab. Firstly; if anyone (neighbors, friends, family) sees you wearing a respirator face mask/hazmat suit they will notify the system protectors. If they accidentally find any of your equipment they may notify the system protectors. If anyone smells chemical odors in your block they will also notify the system protectors. Don't be an idiot and take unnecessary risks. Rent a small cottage/farm in an isolated place. If you can't afford to, then you shouldn't be working with explosives anyway and should consider limiting your operation to one which only requires guns.

- Rent a cottage in the rural parts of your country for this purpose. The cottage needs to have electricity and running water. Cost: 100-500 € per month. You probably need the place for at least 3 but up to 6 months depending on the quantity of explosives you intend to manufacture.
- Camouflaging your lab: invest in "fog stickers" to temporarily put on all windows, or use curtains. You may have to open 1-2 windows to ensure proper ventilation so make sure no one can look directly in by placing panels or something else to cover the lines of sight. Cost: 20-50 €.

Hardware, regulators, glassware, solvents, dry chemicals, acids, etc. stored in the laboratory must be isolated from each other in separate cooling bath to prevent breakage and to avoid other undesirable interactions.

Electrical equipment including varices, stirrers, vacuum pumps, etc. must not be powered by extension cords or frayed line cords. Grounded plugs must be used without exception; existing ungrounded plugs must be changed immediately (this will be too costly to avoid, shouldn't be a problem with good ventilation).

Carefully check glass vessels for star cracks, scratches or etching marks before each use. Cracks can increase the likelihood of breakage or may allow chemicals to leak into the vessel.

Seal glass centrifuge tubes with rubber stoppers clamped in place. Wrap the vessel with friction tape and shield with a metal screen. Alternatively, wrap with friction tape and surround the vessel with multiple layers of loose cloth, then clamp behind a safety shield.

Glass tubes with high-pressure sealers should be no more than 3/4 full. Sealed bottles and tubes of flammable materials should be wrapped in cloth, placed behind a safety shield, then cooled slowly, first with an ice bath, then with dry ice. Friction tape (electrical tape): The rubber based adhesive makes it an electrical insulator and provides a degree of protection from liquids and corrosion. In the past, friction tape was widely used by electricians, but PVC electrical tape has replaced it in most applications today.

When working with sensitive electrical components or volatile materials (such as papers/powders/flammable liquids) sparks and electrical discharge can cause catastrophic failure in sensitive electrical components and ignite volatile substances. Take steps to eliminate them: How to prevent static electricity: Hair, clothes and shoes are well known producers of static electricity. Ground the static by touching a grounded appliance, wiring a ground circuit, or by applying a neutralizing charge. Static accumulates in areas where the charge cannot escape.

Here are some methods to eliminate static electricity and/or buildup:

- Wire work surfaces to grounding points. Resistant "Touch Me First" grounding pads let users drain off any static charge they've accumulated without causing a spark or a shock. Wear static control wristbands, which are wired to grounding points (Do NOT wear them when working on CRT [Cathode Ray Tube] televisions or computer monitors. More than a few people have been killed when the strap touched a main capacitor).
- If nothing else is available, touch a grounded metal object once in a while to remove any charge from your body. Touching a water tap works extremely well. (as does touching a corner of a wall where there is metal stripping under the plaster) These molding strips are not always grounded!
- Professional devices are available that control static electricity by use of alpha emitting devices containing Polonium.

Sparks from electrical equipment can serve as an ignition source for flammable or explosive vapors or combustible materials. Ensure that you have acceptable ventilation to prevent "explosive fume" buildup near powered electrical equipment. All electrical cords should have sufficient insulation to prevent direct contact with wires. In a laboratory, it is particularly important to check all cords before each use, since corrosive chemicals or solvents may erode the insulation. Damaged cords should be repaired or taken out of service immediately, especially in wet environments such as cold rooms and near water baths.

When it is necessary to handle equipment that is plugged in, be sure hands are dry and, when possible, wear non-conductive gloves and shoes with insulated soles. If it is safe to do so, work with only one hand, keeping the other hand at your side or in your pocket, away from all conductive material. This precaution reduces the likelihood of accidents that result in current passing through the chest cavity.

Minimize the use of electrical equipment in cold rooms or other areas where condensation is likely.

If water or a chemical is spilled onto equipment, shut off power at the main switch or circuit breaker and unplug the equipment.

Plug only equipment with three-prong plugs should be used in the laboratory. The third prong provides a path to ground for internal electrical short circuits, thereby protecting the user from a potential electrical shock.

Circuit protection devices are designed to automatically limit or shut off the flow of electricity in the event of a ground-fault, overload or short circuit in the wiring system. Ground-fault circuit interrupters, circuit breakers and fuses are three well-known examples of such devices.

Fuses and circuit breakers prevent over-heating of wires and components that might otherwise create fire hazards. They disconnect the circuit when it becomes overloaded. This overload protection is very useful for equipment that is left on for extended periods of time, such as stirrers, vacuum pumps, drying ovens, Variacs and other electrical equipment.

The ground-fault circuit interrupter, or GFCI, is designed to shutoff electric power if a ground fault is detected, protecting the user from a potential electrical shock. The GFCI is particularly useful near sinks and wet locations. Since GFCIs can cause equipment to shutdown unexpectedly, they may not be appropriate for certain apparatus. Portable GFCI adapters (available in most safety supply catalogs) may be used with a non-GFCI outlet.

Equipment

- Bucket of cold water: 5 € (any kitchen store).
- Fire extinguisher: 100 € (various stores).
- Hazmat suit. For example: Lakeland DuPont HazMat Suit Tychem: 11-50 USD (Ebay). A hazmat suit with boots and hood isn't necessarily needed for making explosives. It is however needed for handling potent poisons. Considering how inexpensive it is, you might as well use one while creating explosives.
- 3M 6800 full face respirator with appropriate filters (choose Organic Vapor/Organic Vapor- Acid/Organic Vapor-Acid-Gas filters) depending on the chemicals you will be working with. You can buy this face-mask with filters from Ebay for as low as 100 USD.
- Freezer: 50-100 € (second hand item, don't put chemicals in your food freezer, to avoid contaminating your food, you need a separate one). Most freezers are able to go as low as -30 °C.
- Refrigerator: 50-100 € (second hand item, don't put chemicals in your food refrigerator, you need a separate one)
- Hot Plate Stirrer: 200 € (second hand or new item). I would really recommend investing in a hot plate stirrer. It's a magnetic stirrer with adjustable stirring speed and adjustable heating so that you may heat up certain compounds (in beakers or conical flasks) without the dreadful task of stirring for 1-2 hours straight. Check Ebay and choose a Chinese supplier. I got mine for 200 Euro, shipping included (found the supplier on Ebay). European versions cost 500-1000 € in comparison.

Glass ware and other basic lab equipment:

- 1 x Funnel, glass 70 mm: 5 €.
- 1 x Funnel, glass 50 mm: 4 €.
- 4 x Funnel, plastic 100 mm: 8 € (purification through coffee filter x 4).
- 1 x Plastic funnel PP 45 mm: 2 €.
- 1 x Thermometer -40-+110: 4 € (for oven).
- 2 x Thermometer -10-+110: 4 € (20 cm long glass variant).
- 1 x Graduated Cylinder 500 ml: 18 € (for measuring liquids).
- 1 x Crystallization cup 140-400 mm: 14-50 (a lasagna glass dish is a cheaper alt).
- 2 x Glass Beaker 2000 ml: 47 €.
- 2 x Glass Beaker 1000 ml: 27 €.
- 4 x Glass Beaker 600 ml: 24 €.
- 2 x Glass Beaker 250 ml: 12 €.
- 1 x Beaker-tongs: 7 (tongs to grab boiling hot beakers).
- 1 x Conical Flask (Erlenmeyer Flask) 1000 ml: 14 €.
- 1 x Conical Flask 500 ml NN (narrow neck): 8 €.
- 1 x Conical Flask 500 ml WN (wide neck): 8 €.

6 x Pharmaceutical Bottle, glass (dark brown) 200 ml: 8 € (storage of detonator. charge/primary explosive underwater).
2 x Pharmaceutical Bottle, glass (dark brown) 500 ml: 4 € (storage of primary explosive).
3 x Pharmaceutical Bottle, glass (dark brown) 1000 ml: 7 € (storage of primary explosive).
1 x pH-paper 0-14, 100 strips: 11 €.
1 x Porcelain Dish 80 mm: 2 € (for boiling on top of conical flask).
2 x Glass rod, stirring rod 6 x 200 mm: 2 €.
5 x Drop counter: 5 €.
1 x Acid resistant gloves: 6 €.
100 x Latex Gloves: 11 €.
1 x Lab-apron: 9 €.
1 x Mortar w. Pestle 100 mm: 11 €.
2 x Pipette bottle, plastic 100 ml: 2 €.
2 x Plastic box, storage, square 500 ml: 6 €.
1 x Plastic box, storage, square 250 ml: 2 €.
1 x Plastic box, storage, square 100 ml: 2 €.
1 x Spoon with spatulas, 150 mm: 2 €.
1 x Spatulas 21 cm: 049610 – 14 – 2 €.
1 x Cleaning brush: 4 €.
1 x Beaker brush 21 cm: 3 €.
1 x Tube brush 400 mm: 5 €.
2 x Plastic container 31 x 43 x 15: 19 € (for evaporation of liquids).
25 x Syringe and needle, 1 ml: 6 € (for injecting pure nicotine into hollow bullets).
100 x Filter paper 125-200 mm: 3 € (fits into large funnels).
1 x Single electrical cooking plate: 23 € (in case you need an extra).

There was a minimum order of 10 for certain items from the supplier I selected. Therefore, I had to buy more glass beakers and conical flasks than needed. Still, I have only listed the required amount of equipment and not the surplus amount I bought. Conical flasks are often better than beakers due to the ease of using funnels etc. in them, + the liquid inside doesn't evaporate as quickly due to the narrow neck of the conical flask.

End note: I tried to contact three international suppliers of second hand lab ware (one German, one British and one US) but they all advised me to just order from a national/local supplier, as glass ware is usually bought locally/nationally due to their relatively low cost. So just contact for example the local supplier in your country who supplies high schools and colleges/universities or alternative suppliers.

CHAPTER II: ADDITIONAL HINTS

Secret Meetings

Note: This section was largely written by Cpl. Vernon Itas.

A security service like the FBI can only achieve its objectives by intercepting communication between people. This means you can beat the security service if you can deny them the ability to overhear your meetings with your contacts. Of course, this guide is to be interpreted not through an American lens but with the correct local political dynamics in mind.

This section teaches you how to check for surveillance before you meet with a clandestine contact. You'll learn a protocol that will beat security services like the FBI, BATF, DEA, and others. The method is particularly effective against standard police surveillance. It also works against the so-called inspection teams of the IRS.

Tradecraft origins: The method described in this article was originally devised in 1943-1944 by countersurveillance expert Anthony Blunt for Britain's MI.5. Unfortunately for the British, Blunt was a deep-cover agent for the KGB. Six years later, Blunt taught the protocol to his new KGB controller, Yuri Modin. Together they perfected the technique as it is known today. They successfully thwarted MI.5 surveillance for three years, sometimes even meeting daily to exchange information and top secret documents. In effect, Blunt was using his inside knowledge of MI.5's surveillance techniques to beat them at their own game.

Proliferation: This countersurveillance method has since been adopted by Israel's Mossad, Germany's BND, Russia's KGB (now the SVR), the American CIA, and many others. The protocol is taught by intelligence agencies to their controllers - these are the intelligence officers who manage and meet with deep cover agents in foreign countries. The method is also being used today by resistance movements and urban guerrilla groups.

When this countersurveillance protocol is methodically applied, it is extremely difficult for a security service to breach your security.

Here's a hypothetical situation. Assume that you and I wish to meet clandestinely. We wish to ensure that our meeting is not observed by a surveillance team. You and I have previously agreed upon a place, date, and time. In addition, we are familiar with each other's appearance - we can recognize each other on sight.

Step 1: You and I independently arrive at the previously agreed-upon general location. Rather than fixing a specific location, we agree to be only in the general vicinity. This is an important principle. This might be a large park, a residential district, etc. The location must be outdoors and free of video surveillance cameras. It should also be selected with the intention of thwarting telephoto lenses. You and I should each know the area well. The location should provide reasonable cover for each of us being there - strolling in the park, walking through a residential area to a bus stop, convenience store, etc.

Step 2: You and I will eventually make eye contact at some distance from each other. We do this discretely, so others are unaware. I use a pre-arranged signal to alert you that I have spotted you. Perhaps I'll throw my jacket over my shoulder, or remove and clean my sunglasses, etc. The signal must be a natural movement that does not attract unwanted attention. Safety first: Even though you and I have seen each other, we do NOT approach each other. This is an important safety valve. If either of us has grown a tail we do not want to compromise the other person.

BACKGROUND: The phrase grown a tail is spy-talk for being under surveillance. The phrase is somewhat inaccurate, because they don't just follow you, they often surround you.

Step 3: When you see my signal you simply walk off. Then I follow you in order to ensure that you're not being watched. I carefully check for the presence of a floating-box foot surveillance team. I check for agents at fixed observation posts. I also watch for drive-by support from a floating-box vehicle surveillance team.

BACKGROUND: In particular, I may follow you, I may walk parallel to you, I may occasionally walk ahead of you. The goal is simply to be nearby so I'm in a position to detect surveillance around you. I always remain at a distance from you, of course, never approaching too closely.

Step 4: When I have satisfied myself that you are clean, I again signal you. Perhaps I re-tie my shoe laces.

Step 5: Now we reverse roles and this time it is I who simply walks off. You begin to follow me in order to ensure that I'm not being watched. You check for floating-box foot surveillance, fixed observation post foot surveillance, and drive-by support by a vehicle surveillance team. What to look for. You carefully watch for persons who are pacing me or moving parallel with me. You check for persons loitering at positions with a good line-of-sight to my location. You watch for an ongoing pattern of people coming and going that results in someone always being in a position to monitor me. You watch for vehicles dropping someone off ahead of me.

Step 6: When you are satisfied that I am clean, you signal me that I'm not being watched. (On the other hand, if you suspect that a surveillance team is in the vicinity, you simply abort the operation and walk away.)

BACKGROUND: You must trust your instincts, because if something seems not quite right it's better to be safe than sorry. Many people are surprised to learn that it is not difficult to detect a surveillance team watching someone else. This is the subtle elegance of Blunt's countersurveillance system. And the goons are helpless against it.

Step 7: You and I can now approach each other and meet. After our discussion we agree upon the date, time, and location of our next clandestine meeting - as well as two backup plans in case the meeting is thwarted by surveillance. If we are unable to meet at the first venue we will use our fallback position and we will meet at the same time and place one week later. If we are unable to make that meeting happen, we will shift to a previously agreed-upon failsafe plan and we will meet at a different location at an agreed-upon date

and time. Neither you nor I writes down the particulars of our next meeting. We commit the details to memory.

BACKGROUND 1: If you have any documents to give me, I will not accept those documents until the final moments of our meeting. I will have already started making my getaway when I accept the documents. This reduces the chance of discovery and arrest by a surveillance team that has managed to elude our countersurveillance protocol. If the security service acts too quickly, they will have no evidence against me, because the documents have not yet been passed to me.

BACKGROUND 2: The best agents never mix discussion and documents. If a document is to be passed, no discussion occurs. The entire contact takes only a moment - the perfect brushpass. The principle is simple. It is foolhardy to stand around holding incriminating documents.

Dealing With Law Enforcement

Note: This section was largely written by Cpl. Vernon Itas.

Golden Rule: Ask for a lawyer immediately upon contact and say nothing. Do not fall for the tricks which enemy law enforcement (LE) may play. Nothing you say can help you. Law enforcement officers are not in a position to offer you a plea deal, only the prosecution is, and even then you are guaranteed a politicized verdict for having opposed the status quo. Judges do not need to accept the plea bargain either. Law enforcement use various techniques to try and get a confession. They will try to minimize your behavior and make it seem wise to agree with them. This is a trick. An in-depth guide to law enforcement interrogation techniques is not required, because all of their techniques can be countered by refusing to speak and asking for a lawyer.

“So LE knocked on my door and asked to talk to me. They say that they know I have been up to no good, and that it will be better for me if I talk to them. What should I do?”

You should under no circumstances talk to LE. They are not your friends, although they may pretend to be. Anything you say can and will be used against you in court. In fact, anything you say will be twisted to put you in the worst possible light. Even if you think you are saying something innocent, LE can twist it against you. So it is best to say absolutely nothing. Don't try to outsmart them in an interrogation, this is not a game, if they think you are the sort of person that sees things as a game they will try and make you feel smarter than them when they question you, but in reality they are just getting you to talk more. When questioned by LE, you should immediately request to talk to your lawyer, and nothing more. Everything you say to LE should be said through a lawyer, in all cases.

Additionally, remember that destruction of evidence is a crime in many places (like the United States). Turning your computer off is not destruction of evidence, even if you are using whole disc encryption (and thus having the computer turned off makes the data inaccessible to the investigators); hitting your computer with a hammer, shooting it with you gun, or throwing it into your swimming pool when you see the police walking to your door is destruction of evidence, and you could be sent to prison for it (even if you are found "not guilty" of the crime itself). You can face a destruction of evidence charge even if the investigators manage to recover the evidence you tried to destroy. If you have

incriminating evidence on your hard drive, you should be using encryption, not relying on your ability to destroy your computer.

“So it is looking like I am going to be doing a bid in prison, but I am being offered a deal if I turn states witness. Should I do this?”

It is true that you can in some cases get reduced sentences by becoming a confidential informant. But would you rather spend five years in prison getting abused and spit on, possibly killed, or spend ten years in prison being left alone for the most part? Snitches are despised more than anyone else in prison, and some of the people you will be locked up with have nothing to lose. Guards are known to reveal information on inmates to other inmates, so don't think you are going to keep your snitch status secret. Even if you are kept in protective custody you will not be safe, when prison riots happen the first thing that happens is the inmates kill everyone in protective custody. In addition to putting your life in serious danger, helping the enemy makes you a coward and a hypocrite. Keep in mind that even if you take a deal to snitch, that has no legally binding power, your sentence is still up to the judge. Although the mandatory minimum is erased when you take a deal, you can still get the maximum sentence if the judge says so, even after you already snitched. This has been known to happen. Even if you get put in the witness protection program and given a new identity, people in witness protection can be traced. Snitching is never worth it and it is never the right thing to do. Don't do the crime if you can't do the time without snitching.

“So I got pulled over, or got a knock on my door, and LE is requesting to search my house or car. What should I do?”

Tell them no. Never consent to be searched or have your vehicle or house searched. Make them get a warrant. Even if you have nothing on you and your vehicle and house are clean, you should make them get a warrant. You don't want to make their job easier. If you don't consent to a search and they search anyways with no warrant then any evidence they gather can not be used in court. If you consent, they don't even need a warrant.

“So I got arrested and am being interrogated, what do I do? They say if I don't cooperate they are going to make things hell for me and put me in a holding cell with a bunch of gang members! But if I confess they will make things very easy for me.”

Ask for your lawyer. If they don't immediately stop questioning you, continue asking for your lawyer. You don't ever want to say anything to cops. Even if they put you in a holding cell full of gang members, it is probably better to be there for a day than to confess and get sent with the same gang members for ten years. Anyways, most gang members are unlikely to mess with you if you just keep to yourself and don't cause any trouble with them. Keep in mind: police lie, secret service lie, they want you to confess, confessing or giving any information up is going to hurt you it is under no circumstances going to ever help you.

“If I ask a cop if they are a cop, they have to tell me right?”

No, cops do not have to tell you they are cops, neither do secret service. Undercover cops lie all the time. So do confidential informants. Be careful who you trust, even friends you have known your entire life can turn.

“But what about smoking weed or using other drugs? Can they do this too?”

Undercover cops can smoke weed, and I am sure they will have no issues using other drugs either. Someone using drugs does not mean that they are not a cop or secret service agent. It also doesn't mean they are not a confidential informant.

“But I am non-important / don't do anything wrong / am small time!”

Even if you do nothing wrong, most LE wants to screw you. The majority of them are not trying to protect and serve, but are trying to meet some alpha male requirement they subconsciously have. They feel important when they bring you down. Also, people tend to minimize what they do, so you are probably bigger than you would like to admit. Be proud but silent of your achievements for the revolution.

“When I talk online I like to say SWIM (someone who isn't me) instead of me or I. This keeps me safe right?”

No, this offers you no protection at all. People who say SWIM are just fooling themselves. People tend to like to have "security blanket security" where they convince themselves they are safe as long as they do some simple ritual (as opposed to taking actual security precautions, which are a bit more difficult). Security blanket security is dangerous, as it doesn't offer real security but makes you act as if you are secured.

Follow these precautions and law enforcement will have a harder time incriminating you. These precautions were written for an American audience and may be adapted to suit other regions. Some regions have lighter laws and some regions have stricter laws. Also, do not follow the advice espoused by 'sovereign citizens'. Police do not care about obscure laws and will break your car windows if you attempt to bring them up.

How To Leave Behind No Evidence

After some operations, the guerrilla or terrorist may not want to be caught or killed in struggle. It is thus important to leave behind as little evidence as possible. Doing so may also allow the guerrilla to participate in another operation and the terrorist to make an even more effective attack against the status quo.

Firstly, we have the preparation phase. Destroy the hard-drive used or clean it using Bleachbit when everything has been set. Burn any paper documents about your plans. Do not tell anyone about your plans. They may become alibis siding against you. It is important to have a cover story for every item that was used in the operation. Do not buy all materials in one store immediately. Buy them over time, like a person who actually has uses for those things would do. You could force yourself to have actual reasons to buy these items aside from the operations, which would make it much more convincing. Also do not use large amounts of these items. Use small amounts. It is much easier to explain how 20 kg of fertilizer disappeared after a pressure-cooker bombing ('I used it on my crops') than 1 ton of fertilizer after a car bombing. One of the largest concerns for us are CCTV cameras. One method would be to avoid them. Map out the locations of security cameras at the target location and along the way on the target route. Also note what cameras are being used. Simple one way cameras? 180° cameras? 360° cameras? Draw the general area they will monitor on a piece of paper. As described before, this paper will

be burnt after the operation. You could visit the target location a month or so earlier to see where the cameras are. Place some dashcams around your car so that you do not have to act suspiciously by taking pictures of all cameras.

Sometimes, you must go through areas with security cameras to reach the target, or maybe the target itself has security cameras. Try to avoid this if possible. Whatever you do, do not let the cameras record your car license plate if you are driving to the target. You could have a fake license plate if your car is very common. You could also use a stolen car or a car bought in cash with no paper work. Just ensure that the car will be destroyed and have no traces of you after you have dumped it. One way would be to park it in a parking lot (without security cameras), cover its insides with gasoline, and plant a time-firebomb. Set the firebomb to maybe 30 minutes later or a couple hours at most. In some operations, the cameras could be shot at.

If you will be seen in person, do everything you can to mask yourself. Wear thick clothes you do not usually wear that cover your entire body. Cover as much skin and hair as possible. Leave as little room in your clothing exposed to air as possible. Tuck your trousers into your boots, jacket and shirt into your trousers, and shirt sleeves into your gloves (jacket could lay over untucked) and tuck them well. Ensure that hairs and skin flakes will not be able to fall through the clothing. Wear shoe covers and mirror sunglasses if possible. You could also be opportunistic. During outbreaks of diseases such as coronavirus and flu, wear a face-mask. Wear mute or dark colored clothing. For maximum safety, buy the clothes in cash outside of large stores. This way, the buying of the clothes will never be registered. I would advise checking out flea markets in another city. Remember to clean the clothes very well before the operation. You should never commonly wear the clothes used.



Clothing worn by an unidentified man who planted a pipe bomb (which was defused) in Washington D.C. on January 5, 2021.

Good choice of clothes:

- Sweatshirt.
- Long-sleeved shirt.
- Beanie under the hood.
- Face and neck covering(s).
- Mirror sunglasses.
- Durable gloves.

- Durable trousers.
- Rubber boots or thick and durable shoes.

Pick a durable material that will not tear or let through particles, something where you can not even smell your own scent.

The more distinctive clothing may be burned or destroyed in piranha solution after the operation. You could also place pillows under the clothing to look fatter, or color your skin darker or lighter if any of it is exposed. Remember to not look too suspicious. Maybe execute the operation during weather when such clothing would be appropriate like when it is cold outside.

When the operation's goal is to assassinate someone with a firearm, numerous factors have to be taken into account to not leave behind evidence after the shot has been fired. Remember ballistics research. Law enforcement can identify the bullet and calculate the approximate distance, barrel length and angle of the shot. It is advised to use a common firearm or (even better) a firearm not connected to you. For example, the Beltway snipers (John Muhammad and Lee Malvo) used a stolen Bushmaster XM-15, an AR-15 style semi-automatic rifle. Another thing the Beltway snipers did was make a traveling sniper's nest in the trunk of their car. This way they could stay hidden, leave almost no evidence behind, and quickly drive off after each shooting.

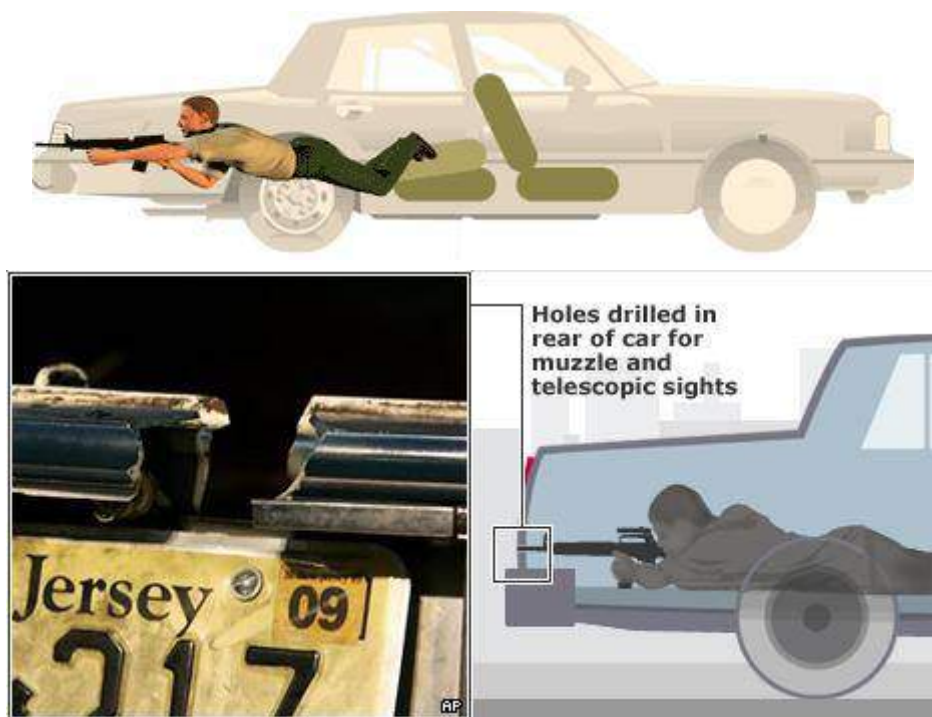

The Beltway snipers were eventually caught due to several reasons. They kept the same stolen rifle with them at all times and never cached it. They also communicated and attempted to extort the police. At later scenes of crimes the shooters left handwritten notes sealed inside plastic bags, including a rambling one that demanded \$10,000,000 and threatened the lives of children in the area. A telephone call from the shooter(s) was traced to a pay telephone at a gasoline station in Henrico County, Virginia. Police missed the suspects by a matter of a few minutes.

On the phone call, the sniper, boasting of his cleverness, mentioned a previous unsolved murder in "Montgomery". This was identified as the September 21 shooting at a liquor store in Montgomery, Alabama. On October 17 authorities said they matched Malvo's fingerprint found at the Benjamin Tasker Middle School site with one lifted from the Montgomery liquor store scene. After confirming the link between these two crime scenes, the FBI was able to link these fingerprints to Malvo due to his fingerprinting during a previous arrest in Washington state. After further research into Malvo's background, the police found he had close ties to John Allen Muhammad. Soon, both were arrested.

The police will play stupid and lie to you during communications, so it is best to avoid communicating with law enforcement. A good example is that of Dennis Rader, a serial killer who managed to evade police from 1974 to 2005. He communicated with the police by letter. In his letters to police, Rader asked if his writings, if put on a floppy disk, could be traced or not. The police answered his question in a newspaper ad posted in the Wichita Eagle saying it would be safe to use the disk. On February 16, 2005, Rader sent a purple 1.44-Megabyte Memorex floppy disk to Fox affiliate KSAS-TV in Wichita. Police found metadata embedded in a deleted Microsoft Word document that was, unknown to Rader, still stored on the floppy disk. The metadata contained the words "Christ Lutheran Church", and the document was marked as last modified by "Dennis." An Internet search determined that a "Dennis Rader" was president of the church council.

Law enforcement could also study the grammar and mannerisms in your communications. Ted Kaczynski evaded police from 1978 to 1996 while perpetrating numerous bombings all across the USA. In 1995, Kaczynski mailed several letters to media outlets outlining his goals and demanding a major newspaper print his 35,000-word essay *Industrial Society and Its Future*. Friends of Kaczynski recognized the ideas in the essay, and the writing style was suspiciously like his. Kaczynski was soon arrested after police raided his home and found homemade bombs inside.

When stealing or extorting money, there are many considerations to be taken. Money should never be extorted as is. Extort it through Monero. Law enforcement have been known to provide cash to extortioners which will tip off banks when the cash is attempted to be put in. This problem isn't concerning if you are attacking a CIT van. What will have to be avoided are dye packs. Dye packs are commonly used to safeguard currency against bank robberies in this manner; when such a pack is taken out of the bank, it releases an indelible dye that stains the money with a conspicuous bright color, making it easy to recognize as stolen. In most cases, a dye pack is placed in a hollowed-out space within a stack of banknotes, usually \$10 or \$20 bills. This stack of bills looks and feels identical to a real one, but usually subtly marked in a way that is only privy to selected bank employees. The development of flexible dye packs makes it virtually impossible to detect by persons handling the stack.

Another factor is to be careful. Treat every operation as if it was the first. Growing careless after getting away with numerous robberies and murders is what often causes bank robbers and serial killers to be caught. Jeffrey Dahmer for example kept the body parts of his victims inside his own home, and in July 22, 1991 was put off guard and had one of his victims escape after the victim punched Dahmer in the face. Jeffrey Dahmer had played around with the victim instead of killing them as soon as the chance arose.

Genetic evidence

Spit, hairs, tears, snot, sweat, skin-flakes, fingerprints and blood are genetic evidence. Avoid having any of these from you end up on the target location and any from victims end up on the equipment you bring back. There are acceptable circumstances where slight genetic evidence can be left. If walking through a parking lot, store, street with homeless people or any other place that experiences crowds now and then, then the genetic evidence is unlikely to be notable. Police would have to have to consider every person that walked that path. Desolate areas are much more risky. Dogs can also be employed to find the path you took in a desolate area, but not an often crowded area.

Avoid leaving genetic evidence in bombs too. There is always the risk that the bomb fails to detonate, is defused, or half-detonates. This could leave your genetic imprint on the bomb material. Wear the appropriate clothing while preparing the shell and shrapnel of the bomb.

If kidnapping and killing someone, get a large plastic bag and place the corpse in the bag. Then clean the room they were in. Genetic evidence can be destroyed with hydrogen peroxide, bleach, and ammonia (separately). Avoid shooting or stabbing the victim, as that will make the cleanup process much more tiring.

Now a process for the most jaded. To dispose of the body by utterly destroying it, pick a room and cover the entire floor in plastic. Place the bag with the body in the middle. Wear a hazmat suit and latex gloves. You will need something to cut the body apart. A machete or kitchen knife will do. Cut the body apart. The parts should fit inside the largest Pyrex glass containers available. Synthesize piranha solution in the containers and put the parts in. The same solutions of piranha can be reused multiple times. When the entire body has been destroyed, neutralize the piranha and begin cleaning the room. The plastic bag and the plastic on the floor can also be destroyed in the piranha solution. The hazmat suit could be cleaned with water first to be easier to handle and then with other chemicals to destroy all genetic evidence. Clean the cutting tool or dispose of it. Clean the entire room afterwards to remove the smell.

Another less horrific process would be to put the body in a barrel (of the appropriate material) and then use large amounts of hydrofluoric acid or more preferably sodium hydroxide (which is a base, not an acid, so it will have to be neutralized differently). This process would however take days, would emit an odor during the entire process, and require lots of heat. Another less reliable method would be to burn the body as much as possible and then dissipate the ashes and bones, or to feed the flesh to crocodiles or alligators.

To put it another way, avoid having to destroy corpses. This can be avoided by killing the target with a firearm assassin-style or walking up behind them at night with no one around and killing them with a hammer.

Manufacturing Explosives – Worth It Or Not?

Note: This section was largely written by Anders Behring Breivik.

Everyone should be aware of the fact that Western intelligence agencies have successfully uncovered and apprehended 200-300 Jihadi cells on European soil since 9/11. 95%+ of them were in the process of creating explosives. Imagine if these individuals had ignored explosives altogether and instead focused on small arms operations. If they had, they would have successfully murdered more than 1000 infidels by now. These were all Mujaheddin though with an apparently rigid mentality.

All guerrillas must ask themselves; should I manufacture explosives or just stick to firearms? This decision really boils down to what you expect to accomplish. A well planned assault with an assault rifle may kill 30 people, while an unsuccessful explosive manufacturing process might result in 1 dead guerrilla and thus 0 enemy executions. Also, there is a 30% chance of being apprehended during an explosive manufacturing process (for a non-blacklisted person with no criminal record) which doubles for every person involved. For a blacklisted individual (blacklisted by the intelligence agency) there is less than 10% chance for success with the manufacture of explosives. If he includes 3 other blacklisted individuals this 10% chance is reduced to 3%.

So the question remains; is it really worth risking your life for a military operation with only 3% success rate? It is probably worth it if you have a realistic chance (50%+) of successfully creating a 500 kg truck bomb, which has the capability to destroy a medium or large building, thus instantly executing many enemies depending on how crowded the building is. However, if your bomb is only likely to have the capacity to kill 1-15 individuals, you are probably better off focusing on perfecting a small arms operation if you are bound to be found out. Those sorts of bombs can be used for operations that the guerrilla will get away with. Small arms operation should result in 10-30 executions for single cell operations, 20-60 executions for duo cell and 30-90 executions for triple cell. So before you decide whether you want to incorporate an explosive component to your operation; be pragmatic and always choose a realistic option which reflects your capabilities. Never choose operations which has a lower than 50% success rate, unless the payoff is exceptionally high. Be ambitious but at the same time; don't be naive. The manufacturing of explosives is not for anyone and should NOT be the goal for everyone. A successful mission MUST be the ultimate goal for any and all guerrillas, and for the most part; this will include limiting your operation to small arms shock attacks of undefended concentrations of enemies.

CHAPTER III: “PREPPING” AND BASE MAINTENANCE

“Prepping” is an activity guerrillas should practice. It prepares the guerrilla for survival in revolution and disasters and helps the guerrilla contribute less to the status quo. The guerrilla becomes more autonomous. Total autonomy may not be possible and the guerrilla does not have to stress over the possibility. Be as autonomous as your time, motivation and wallet will allow. Do not do foolish actions because of attempting to reach the optimal “prepping”.

What To Stockpile

Storms, floods, nearby battles, sieges, etc. There are many reasons why a base could become isolated for a long period without any supply lines connected to it. The base will have to stockpile on those supplies in advance. The base will also have to stockpile materials for easier living and defense. But what to stockpile? Here is a brief guide:

- Food and water is what will be most stockpiled. Store in cool, dry places away from sunlight.
- Medicinal items are very useful especially during revolution. Otherwise it is advised to acquire medicinal items from hospitals.
- The importance of firearms and ammunition is overstated. The important thing is to have a reliable firearm that everyone present will know how to operate. Store far away from children.
- Tools are good to stockpile in case anything needs to be repaired.

Catalog inventories. Note how much of what there is.

There are many useful skills to know for “prepping”:

- Car repairing.
- Cooking.
- Gardening.
- Knitting.
- Sewing.
- Woodworking.
- Welding.

Food

Food is the most important resource to stockpile. Stocking up now on the right non-perishable food items will help you in disaster situations with less stress. Fueling your body during an emergency is very different from your everyday diet. (Think of how an emergency fund functions differently than a savings account.) Because you’ll probably expend more energy than you normally would during your emergency plan, you should eat high-energy, high-protein foods. If the emergency is disease-related (as in the coronavirus pandemic), it is especially important to eat nutritious foods that will help you maintain good

health. And because you'll have a limited supply in your emergency preparedness kit, the higher-quality foods you eat—and the fewer of them—the better.

It is highly advised to learn how to properly can the stockpiled foods so that they can last for longer. Canning foods protects them from bugs, germs, light and deterioration from water. There are many canning guides for different foods. Generally what is needed is a jar, food, preservatives, canning liquid and a canner. Remember to wash your hands before executing the process.

These non-perishable food items (or close to it) have lengthy expiration dates, so you can stash them away for long periods of time. Make a list of everything in your stockpile and check expiration dates every six to 12 months to keep things fresh. And don't forget to have a can opener on hand at all times—all that food won't be of any use if you can't open it. Some long-lasting foods are peanut butter, whole-wheat crackers, nuts and trail mixes, cereal, fruit bars, high-cacao chocolate, honey, dried fruits, dry meats (beef jerky) canned meats, canned vegetables, canned soups and chili, dry pasta and pasta sauces, powdered milk, and spices like salt (read next 2 paragraphs) and pepper. Store the food somewhere cool, dry, and away from sunlight. Keep around a couple propane or charcoal stoves for cooking. Even during emergencies, keep a diverse diet.



Shelves of different canned foods.

Pure salt does not become spoilt as foods do traditionally. Foods spoil due to bacteria & other microorganisms, but most of these won't grow at all in salt. Moisture is the primary enemy of salt, as it will cause it to harden after clumping up, thus dissolving the crystals. The more the water presence in salt, the less effective it becomes for its intended purpose.

The perfect container to store salt in has to be airtight & watertight. However, it should not be a metal container as salt is corrosive. The ideal containers have to be plastic, glass,

vacuum-sealed bags, or mylar bags. Whatever the container used, you have to remove as much air as you can with a vacuum cleaner after washing the container.

Water

Of all the supplies we stockpile for emergencies, storing water is the most difficult. The biggest problem is the sheer volume of water that we need to stockpile in order to ensure that we will have enough to see us through an emergency. We use more water than any other single consumable. This means that our water storage needs more space than even our food storage. Yet, most people don't store enough of it.

Let's start by looking at how much water the average person needs for survival. Pretty much any survival instructor you find will tell you that the average person needs one gallon of clean, purified water per person, per day for drinking and cooking. That's fine if you live in a temperate climate. But if you live in the Southwest, in southern Florida or southern Texas, it might not be enough. In the high temperatures and blazing sun of those areas, you can sweat out a gallon per day.

But drinking and cooking aren't the only ways in which we use water. We use it to wash our clothes, our bodies, our dishes, and our homes. In addition, we use it to flush our toilets, brush our teeth, and water our gardens. All in all, the average American family of four uses about 400 gallons of water per day.

Obviously, we won't be able to do that in a survival situation. However, we won't be able to fully ignore those other needs, either. Those of us who are gardening to augment our food stocks can't and shouldn't stop watering our gardens, just because we don't have tap water. We also need to maintain at least a minimum level of cleanliness, just to maintain our health.

So, I would say that for most families, a figure of three to five gallons of water per person, per day is a much more realistic figure. Of that, the only part that needs to be purified is what we use to drink. Even then, we're going to have to be very careful about how we use that water. Washing machines and automatic dishwashers will be totally out, as will nice long baths and showers. You'll have to flush the toilet with grey water or not at all.

"Where should my water come from?"

You can buy purified water in the grocery store and stockpile it for emergencies, but that's not the most cost-effective way of stockpiling water. At about one dollar per gallon, you'll end up spending a lot of money to have enough water. It's even worse if you buy bottled water because you are paying for the individual bottles.

The advantage of buying pre-packaged, purified water is that it is probably purified to a more stringent standard than that which comes out of the faucet. However, there are ways of making it pure yourself. Two popular purifiers on the market, the Berkey and the Sawyer, will both purify water for much less than it costs to buy purified water from the store. In fact, they are even cheaper than buying your purified water from the corner water kiosk.

Purifying your own water may seem like a lot of extra work, but if you're putting the purified water into some sort of tank, it's really not that bad. I've done this for years and it really doesn't take all that much time.

"Should I bother with purified?"

However, you don't even need to purify your water before storing it. If your tap water is good enough to drink, then why wouldn't it be good enough to use in a survival situation? For that matter, about three-fourths of the water you need in a survival situation doesn't need to be purified, so purifying everything else is a waste of time.

You can store non-purified tap water for a prolonged period of time, just like the expensive bottled water. About the only difference is that you do stand a risk of algae growing in the water, especially if you keep it somewhere that sunlight can get to it. So do not keep it near sunlight! However, this problem is easily (though desperately) solved by adding a very small amount of bleach. Avoid doing this if possible.

I keep most of my water stockpile in 750-liter tanks. That's about the biggest size you can carry in a pickup truck, which is how I ended up picking that size. Every six months or so I add eight drops of bleach per gallon of water to the tanks. Since the standard for measurement is 20 drops per cubic centimeter, that works out to 80cc of bleach. That's enough to kill any bacteria or algae which have gotten into my water.

"What about containers?"

Besides the space, the biggest problem with storing water is finding containers that allow you to store it efficiently. My 750-liter tanks work well, but I buy those in Mexico. That's a little far for most people to drive. However, you can buy what are known as "intermediate bulk containers" used and for a very reasonable price. These are used for transporting a wide variety of chemicals and typically will hold 275 gallons of water. While new ones are \$400 to \$550, used ones range from \$30 to \$50.

The risk in using these containers is that there may be residue from the chemicals which were in the tank before you bought it. Therefore, it is very important to know what chemicals were transported in the container beforehand and how to clean them out thoroughly.

You can find information about the chemicals online, simply by searching for the chemical by name. That will tell you the properties of the chemical, whether it is poisonous and what works as a solvent for it. Armed with that information, you should be able to clean the tank out thoroughly.

Many people use 55-gallon plastic drums instead of the intermediate bulk containers. Not only are they easier to find, but they are also easier to store, as they will fit through a doorway to get them in the basement. If you can find white 55-gallon drums, rather than the more common blue ones, it indicates that the drum is "food grade." That means it was probably used to ship



55-gallon drum.

something edible, like cooking oil or corn syrup. Those are the safest bulk containers you can buy used.

Avoiding Fires

Protecting your house or base from fire becomes a priority if you live in fire-prone regions. However, preparations against fire are not limited to houses in these regions only. The National Fire Protection Agency reported that domestic fires in America have been on a steady rise since the 90s. One may be forgiven for thinking that people would be more equipped to protect their homes from fire due to the several technological tools for early detection and fire suppression. But this is not the case. We still have a lot to learn.

Like most house owners out there, I'm assuming you have smoke alarms installed already. Also, there's a fire extinguisher on your kitchen wall to kill those little kitchen fires before they go rogue. These are surely good steps, but they are little ones in the right direction. The casual fire extinguisher you have at home will only put out small fires and only if applied on time. More so, these are merely the basics for killing a fire that starts inside. What's your plan for putting out a fire that starts outside your house? How do you intend to deal with wildfires?

According to the National Oceanic & Atmospheric Administration, America has been hit year after year by devastating wildfires, and every successive season turns out worse than its predecessor. For instance, over 40 million acres have burned since 2017. In California alone, more than 10,000 structures have been damaged from over 9,000 wildfires.

Protecting your home from wildfires has to be taken very seriously, even if you live where you believe to be very safe. You are not 100% excluded even if there's a green belt surrounding your region. Fire may fall from the sky if a nearby area is burning. It's hard to put out a fire burning at 1,500° with an extinguisher, don't you agree?

I should mention that the strategies below do not guarantee absolute protection from fires. However, they greatly reduce the risk of occurrence and cut down on the damage these fires may cause.

Set up a residential sprinkler system. Installing a sprinkler system for your residence has to be one of the first steps you take when preparing against fires. It is recommended that you incorporate it in the building process of your home. In cases where you or the constructor did not, the responsibility falls on your pockets, and I must say it can be white hefty. If you would rather not spend so much on an afterthought sprinkler system, you can opt for DIY projects and certain kits designed for the purpose. However, these systems don't look very appealing.

Set up a natural fire breaker barrier. The presence of a green belt around your home may not guarantee you absolute protection, but it remains one of the most effective and inexpensive setups for protecting your home from fires that start outside. A natural fire breaker barrier is a space that you leave between your structures and the woods (or any other combustible material), and other houses nearby.

The main purpose of this is to make it difficult for the fire to get to your home. Some states recommend that your fire breaker barrier is at a foot radius of 30-100 around your home.

Note that the wider your fire breaker, the harder it is for a wildfire to get to you. Fires burn uphill, so you must know the slope of your home first. An upward slope helps the fire to climb. So, if your property has a great slope, the bigger the fire breaker to set up.

With your natural breaker in place, it is necessary to control the shrubbery and trees surrounding your home. You have to be smart with your designations. There are plants that aid fires and others that slow them down. Go for plants that shed fewer leaves and with a lot of moisture. The former means there isn't a lot of natural fuel for fire to build on, and the latter ensures some resistance to the fire. Plants like these are described as fire-proof, and the commonest ones include wintergreen, moss phlox, ninebark, wild geranium, nannyberry, bearberry, and columbine. When planting trees, only select those with rough bark and low sap or resin content. You can consult with your local landscapers to make the appropriate choices here. When shrubbery and trees are controlled, it becomes necessary to maintain them too.

For interior fires, use foams and gels. Foams are useful for putting out interior fires. They do so by making a thick blanket that sucks oxygen out of the fire, thereby putting out the fire. These foams last for 16 hours on surfaces as they are absorbed by construction materials. However, I'm not referring to ordinary foams. They are EPA-approved and biodegradable. Foams make good fire-protection tools as they do not stain or damage your structure, nor do they kill plants. You can spray foams with a garden hose or a mechanical pump. You don't even have to clean up after using foams.

Fire-retardant gels are also a substitute for these foams, but they bring quite the mess, and cleaning up after them costs a fortune. Also, gels will last for only five years, but foams take up to 20. Also, opt for buy-retardant paint and additives when constructing your house or doing some repairs. These materials are available for interior and exterior usage. They help in keeping fire from spreading.

ELECTRICITY

Electricity is very important. It not only gives an electric current to run the lights and electronics but also the heat of the house and the power to the refrigerator that stores food. Power outages could be caused by disasters or sabotage and the guerrilla or concerned citizen must be prepared.

Generators

In the short-term, a power failure is an inconvenience. In the longer term, food begins to spoil, the cold from outside makes its way indoors and doing anything after the sun goes down is next to impossible without light. This a problem that needs fixing and to do so means thinking ahead. Time your home gets its very own backup generator.

The two main types of generators are portable and permanent, standby styles. If you want to produce electricity for a few lights, and perhaps a furnace and a refrigerator, you can manage with a portable, less expensive model. However, if your needs are greater — for instance a well pump, a freezer or air conditioning — you will need a standby generator, which automatically turns on when the power goes off.

Whichever type you decide to use, you will need to match its size to your home's power requirements. If the generator is too small for your usage, not only will it break down sooner, but it can ruin appliances that use more current than a smaller model can deliver. Sizes are measured in kilowatts (1kW = 1,000 watts). A 5-kilowatt portable generator should provide electricity for a refrigerator, furnace fan, a few lights and a laptop. To calculate the size you need, refer to your appliances' specifications label.

To find its wattage, add the amounts together, and double the total to allow for the surge some appliances, like refrigerators or air conditioners, caused when they cycle on. Also, be sure the generator you choose will deliver the 120 volts a typical home's circuitry requires. A too high of voltage, or output variation during heavy load times can cause some appliances and electronics to run hot. That will determine your minimum wattage during an emergency.

Generator fuels

Permanent, standby generators tend to run on existing fuel lines, either propane or natural gas while portables predominantly run on gasoline. But portables can run on a wider variety, including natural or propane gas, and diesel or biodiesel. Your choice of fuel will depend on the use you require from the generator, as well as what is most available in your locality.

1. Gasoline: Less expensive models use gasoline, which itself is cheaper and more readily available than diesel or propane. The disadvantages are that gasoline-powered models operate at a higher RPMs, which shortens their lifespan and makes them extremely noisy. Storage is another issue — you cannot store the fuel in closed areas for safety reasons. Gasoline also has a shelf life of about six months, so you cannot really keep large amounts in case of emergency.

2. Propane: Propane generators have considerable advantages over gasoline by way of their longevity and cleaner operation. The propane comes in filled cylinders, which are easily connected and switched out for full ones. A 45-gallon cylinder tank can, depending on the generator itself, power an 8-kilowatt model, providing electricity for several appliances for 24 hours. The disadvantage is propane is the most costly of the liquid fuel options but it does not have a limited shelf life like gasoline and diesel.

3. Diesel models tend to be available as permanent, standby types versus them being found as portables. They are more efficient and will last longer than their gasoline-powered counterparts, if they are properly maintained. Diesel models also operate much quieter and they run at a lower RPM speed, prolonging the life of the generator. However, diesel generators are significantly more expensive than other types, and can be harder to find. Storing diesel, as with gasoline, is problematic as it is prone to degradation due to algae growth.

4. Solar and wind-powered: Photovoltaic portables can run and portables can run, while not the traditional type of generator considered when thinking of emergency power, are viable alternatives to fuel-based models. Both systems are designed to produce electricity (solar during daylight hours and if there is wind, the wind turbine will produce) which is stored in batteries and converted to AC power for your home use. These might not be used in hidden bases as they are easily spotted by planes, drones and helicopters.

Fuel-powered generators consist of an engine, an alternator that converts energy from the engine into electricity, plus an output/control panel housing circuit breakers, outlets and switches, all held together by a frame. Diesel and gasoline-powered generators also have a fuel tank. Engines can be air cooled or liquid cooled, the air-cooled ones are cheaper, and better quality generators have overhead valves (OHV) — these run smoother and quieter, and produce less emission.

Connecting

Smaller portable generators that produce enough power for a few appliances can be connected with extension cords. Make sure you use a heavy-duty cord that will not cause excessive drop in voltage, especially if they are connected to larger appliances like refrigerators, freezers and air conditioners. A poor-quality cord is dangerous as it can overheat becoming a fire hazard.

A potentially safer alternative is a transfer switch. A transfer switch is a special electrical panel that is installed as a subpanel off the main circuit-breaker panel. This way, even with a portable generator, you can provide electricity for entire circuits in the house, not just individual appliances. This option does require an electrician to install.

Storing Off-Grid Electricity

Going “off the grid” means more than simply getting some or even all of your power from the sun and/or wind. It means having a means to store this power so that it can be used when the sun is not shining and the wind is not blowing. Thankfully, there are a wide range of battery energy storage system options available on the market, with some affordable models costing less than \$100 per battery. Even so, those who have a limited budget and/or a large family (which would require the purchase of a number of batteries) may be tempted to wonder if the expense of buying and maintaining an electricity storage system is really worth it. Following are some points that outline why such a system is not just a good idea but also a necessity.

Thankfully, there are a wide range of battery energy storage system options available on the market, with some affordable models costing less than \$100 per battery. Even so, those who have a limited budget and/or a large family (which would require the purchase of a number of batteries) may be tempted to wonder if the expense of buying and maintaining an electricity storage system is really worth it. Following are some points that outline why such a system is not just a good idea but also a necessity.

The United States is a first world country and electric blackouts are not nearly as common here as they are in Asia or Africa. Even so, it is important to be aware that you can easily lose power with little or no warning. A freak storm, for instance, can cause a blackout for a few days or even a week, as can a malfunctioning or broken part at an electricity plant. It is also important to be aware that there are much more serious potential threats to our power grid system.

An EMP, for instance, could knock out electricity in the entire country in a matter of seconds. Solar flares can also wreak havoc on the electric grid; what is more, the odds of such a flare hitting earth are much higher than many people realize. In fact, a senior member of the House Homeland Security Committee noted less than a year ago that the

likelihood of a severe geomagnetic event damaging the electric grid currently stands at 100%. A terrorist attack could also cause significant damage to the grid.

Given the fact that electricity is a must for essential home appliances (i.e. refrigerator, stove, and certain types of medical equipment), a battery system can save you a lot of money, hassle and even prevent you from getting sick. In the event of a long-term power blackout, having an electric battery storage system can mean the difference between life and death.

“Is it Really Your Job?”

Some would question whether providing electricity for their family is really their job. Such individuals often place a great deal of faith in the state and federal government, counting on these institutions to restore power in a timely manner, regardless of what the problem is. Unfortunately, this faith is often misplaced. In the event of a freak storm that knocks out power for millions of people, it could take days or even up to a week (or longer) for power to be restored in your area.

In the event of an EMP, solar flare or terrorist attack, you could be without power for well over a year. The reason for this is the fact that the components that electric companies rely on to provide power are not made in the United States but overseas. These components are custom made on request; there is no ready-made stock to order from should a power outage occur. Even if parts were ordered right away, it would take anywhere from 12 to 18 months for them to arrive in the United States.

Given the above-mentioned facts, two things are very clear. First, it is all too easy for the electricity to go off when you least expect it. Second, the government may not be able to bail you out as quickly and/or as effectively as you would like. Given these facts, it is clear that having your own electricity storage system is the only way in which you are guaranteed to have the power you need, when you need it.

CHAPTER IV: FOREIGN VOLUNTEERING

Here are some armed organizations:

Organization	Ideology	Size	Can I join?	Power
Ahrar al-Sham.	Sunni Jihadism.	20,000.	Yes.	Moderate.
Al-Qaeda.	Sunni Jihadism.	40,000.	Yes.	Strong.
Azov Battalion.	Nationalism.	1,000.	Probably not.	Moderate.
Donetsk Republic.	Nationalism.	25,000.	Possibly.	Strong.
Hamas.	Sunni Jihadism.	25,000.	Possibly.	Strong.
Hezbollah.	Shia Jihadism.	100,000.	Possibly.	Strong.
Islamic State.	Sunni Jihadism.	100,000.	Yes.	Strong.
Leon Sedov Brigade.	Communism.	200.	Possibly.	Weak.
Liwa Fatemiyoun.	Shia Jihadism.	15,000.	Probably not.	Moderate.
LRA.	Christian extremism.	?	No.	Weak.
Luhansk Republic.	Nationalism.	15,000.	Possibly.	Moderate.
Naxalites.	Communism.	20,000.	Probably not.	Moderate.
NRF.	Anti-Taliban?	8,000.	No.	Weak.
Philippine Communists.	Communism.	?	No.	Weak.
Shining Path.	Communism.	4,200.	Probably not.	Moderate.
YPG.	Far-left.	135,000.	Yes.	Strong.

*The possibility for a foreign volunteer to join the organization.



British volunteers of the YPG.



Volunteers of the Islamic State.



Volunteers of the Azov Battalion.

There are many flavors of extremism and anti status quo action, as these images illustrate. Pick the organization you will be joining wisely. Join the group with the ideas most like yours. If you are a fugitive, you will be spending a long time with these people, so you will need to learn their culture, manners, and language.

What To Expect In Foreign Warfare

Note: This section was largely written by Mukhtār Ḥassan. He has many anecdotes from his time with Al-Qaeda in Afghanistan and Iraq.

Knowing what to expect when volunteering for foreign warfare is vital in order to avoid confusion, shock, and even depression. The psychological state of mind one is required to have in warfare is far removed from what we see in propaganda videos. In simple language, it's not all about the shooting and ambushing of the enemy; rather it is much greater than this. Here, we will be covering numerous points throughout this text. The transition in mindset is what one needs to focus on when reading through these points.

Language and culture

When coming to any war-zone, it is important to be able to speak the local language fluently. If one doesn't, they will have great difficulty in getting around and communicating with the fellow guerrillas. The biggest problem with this is not being able to talk, to hold a proper conversation, nor expressing oneself. At first, it doesn't bother one for some time as long as they know some basic expressions and words to get around. However, after weeks pass and time goes on, it starts to have an effect on the heart. One will start to realize the importance of socializing because they will be left out of discussions and will not know what's going on except when directly addressed to do something. One would begin to miss their homeland, the comforts, the easiness in life and so on.

A friend of mine who went for jihad in Afghanistan told me he was depressed for some time even though he had a translator at all times. When I inquired as to why, he told me that there was nobody he could really express himself to. This brings me to the next point.

Part of being able to express yourself properly is by helping a close and trustworthy friend of yours to join you in the war. He should be a friend that understands you, and whom you trust. In war, as we will see later, there will be long periods of downtime; so to have a companion is essential in staying steadfast and remaining patient. Of course, if you are unable to bring a companion, that doesn't excuse you from joining!

One should study the culture well before coming to the land. They should be aware of the dos and don'ts as well as the cultural practices which are impermissible in whatever ethical system the locals follow. In Yemen for example, one will see the people chewing khat nearly everywhere he goes. This is different from most other Muslim cultures, which consider doing so haram – forbidden. In addition, it's important to know how they dress, the dialect they speak and the local customs (such as how they conduct wedding celebrations, hand movements, etc.); this is so that you don't stand out as a foreigner entirely.

What to bring

Now on what to bring and not to bring. When in war, one has to bear in mind that they will have to pack light since one will be constantly moving from one place to another and it wouldn't be practical to carry large suitcases everywhere one goes, especially if the car ride is tight. What I recommend is bringing a solid, well-built backpack that can last in any

weather condition. Bring two to three pairs of clothes; don't worry about them getting dirty, since in nearly every base, you should be able to clean the clothes.

Bring your essential bodily cleaning items and associated gear appropriate to the weather, a water resistant wrist watch, flexible boots (bring an additional pair of sandals or flippers if going to a hot region, as walking around in boots all day will not be comfortable), a vest jacket with many pockets, a few books, a dictionary to understand the locals or signs, and a secured laptop. There will be some outlets for electricity in most war-zones, but they will not be as common as in the homeland.

Bases

The bases vary throughout the region. Some of the rules for most bases include not traveling outside the base whatsoever, speaking in a low voice, not shooting your gun, and not using the cell phone. In some cases, there are bases that forbid the use of electronic equipment.

When living in the base, make your time useful. The day will go by slowly. If you can speak the local language, try to benefit from the company of the guerrillas. If you are not assigned to any obligations, do your best to spend a good portion of the time reading and studying. Get accustomed to reading books as they are the best of companions; it never bothers you; it is always available when you need it, and it will further your comprehension in any matter you are interested in. There is so much to do in your free time. Here are some more activities:

- Spend quality time with your new friends.
- Exercise.
- Practice fighting moves and various military strategies.
- Study military manuals.
- Research medicine and field healthcare.
- Watch beneficial documentaries.
- Learn to cook food.

And if all else, you could go wash everyone's clothes and clean the place of study.

You will begin to realize the importance of having free time when you lose it. So take advantage of your free time, and spend that time wisely.

Living outdoors will be the most difficult of bases to stay. In some bases, it won't be too bad since the guerrillas will erect tents and there might be some basic comforts. It is possible though that there will be times where none of this will be available and you will have to sleep on straws on the ground. They may or may not have blankets and sleeping bags available.

As for the weather, you should do some research into the country before arriving as to know what it's like during the day and night, especially in deserts, mountainous regions and forests so that you come prepared. Also, the type of weather should help you determine what kind of footwear to purchase. Remember to take good care of your feet and wash them properly. As a guerrilla fighter, you will be on your feet most of the time.

Downtime

Not witnessing battle for extended periods of time is what many of us go through. In Iraq, there was a group of mujaheddin who stayed inside a house for three months straight and witnessed no fighting even though the fighting was hot and active on a daily bases. Also a mujaheddin from Afghanistan who told me that he remained there for a year and only took part in an operation once. These are not unique cases; this is completely normal. In the lands of warfare, you get to taste the fruits of struggle. The downtime in jihad is a blessing and not a negative aspect. It gives a chance to perform righteous deeds, gain knowledge and correct the soul's intention.

Warfare tips

Drones are used as weapons in some regions. If you hear a wizzing sound over your head, run and find cover. It's a drone. It will drop a bomb soon. You will not be able to see it with your eyes, and when you do, you're probably too late. The Islamic State employs these kinds of drones in Syria and Iraq.

Beware of other aerial attacks too. Bombings from US and IDF missiles in the West Bank, Syria, Iraq, Yemen and northern Pakistan will be much more powerful than the bombs dropped from Islamic State drones. These bombs can make craters 10 to 20 meters wide and 5 to 10 meters deep. Spy planes that are impossible to see will be sent over the bombed areas to see if there is anything left. Hide until reinforcements arrive and pray as much as you can to whatever god you believe in while and after the bombardments occurred. Bombings from US and IDF missiles are only a worry if you are against the US or IDF militantly. Bombings and drone attacks may occur in Ukraine against Ukrainian targets such as the Azov Battalion but less frequently.

Fugitive

You have committed a very brutal operation and are certain that law enforcement will identify and arrest you. What now? There are three choices. You could be arrested and spend your life in jail, or until you are saved if there is a powerful organization. You could die in combat with police or die by suicide. Or you could become a fugitive. Beware that Interpol have you wanted for years.

It is best if you go to another region, but staying may work in larger regions. Yaser Abdel Said, an Egyptian-American murderer, managed to evade law enforcement from 2008 to 2020. He had stayed in the USA with the aid of his 2 sons who rented him apartments. A person at one of the apartments recognized Yaser in 2017, and he was captured in 2020 as police had began 24-hour surveillance on a home in Justin, Texas. There they captured Yaser.

One could become a fugitive in another region. There are many organizations that would gladly let you join after killing some of their enemies, if you hold similar beliefs to them.

The life of a fugitive is not to be viewed as easy though. You will have to be a militant for the organization you join. You might be kept out of a couple battles if you executed a particularly effective operation as the organization will keep you around for propaganda

reasons (see Jihadi John). It is best to begin building a solid reputation in the organization to disincentivise other members from collaborating with Interpol.

There are numerous ways to get to the locations operated by the organization that will protect you as a fugitive. Possibly the best technique would be to fly to the target organization. Consider this plan:

1. Detonate car bomb against powerful institution. You are certain to be found out.
2. Take numerous safety precautions to slow the investigation.
3. Use that spare time to fly to another region occupied by the organization.
4. Quickly join the organization.
5. Live far off while defending yourself from Interpol.

Ensure that the airports will not be closed after the operation has been executed. This can be done by not targeting airports or places near to airports. In case of failure, save a backup plan. Maybe go to another airport, or attack another target and die as a martyr or be captured.

Risks Of Volunteering

1. The most obvious risk of volunteering in foreign warfare is death or injury. Getting shot, bombed, hit by shrapnel, executed, ill or tripping off a cliff are all things that could happen. What prevents the people you are shooting from shooting back?
2. Risks associated with transportation to the target region are to be considered. An entire party of young and very religious Muslims going for “vacation” to Syria or Iraq will be questionable to law enforcement. Do not smuggle goods to the region. You are to be as clean and innocent-appearing as possible when in transportation.
3. Transportation failure can prolong the time spent in the region for longer. Transportation methods might be slowed down by different variables such as weather, bureaucracy and interception by bandits.
4. The risk of being found out can be dangerous if you were in an organization which is militantly against a powerful state. This is especially the case if your homeland is ruled by the state directly or indirectly. The powerful state could also send Interpol to kidnap you like Abdullah Öcalan or execute an operation to assassinate you like Osama bin Laden. Even if you change identities this will be possible like with Adolf Eichmann.
5. Confusion. It could happen that people you know or law enforcement believe that you have joined an organization against a powerful state when you have not. This could happen if secretly going to Syria to join the YPG. They might confuse the activity for Islamic State activities. The matter will be settled in court if police care.

CHAPTER V: TECHNOLOGY AND SECURITY

Note: This chapter will almost certainly be outdated in by the year 2025.

Hardware

The electronic hardware used will have to be considered. Inappropriate hardware could cause an operation and location of the device to be exposed. The options possible must be trusted and reliable. Most of the measures detailed in this section will not need to be taken by the average guerrilla.

Computers

Computers are very privacy respecting. Here are the basics to make it even more secure. Laptop computers are the ideal hardware for communications and storing information. The computer does not have to be very good but still durable. Optimally it should be cheap also. Avoid Mac computers as they reach none of the requirements. The computer should be built from separate parts if a stationary computer will be used as it will become cheaper.

PC Part Picker is a good website for buying computer parts: <https://pcpartpicker.com/>

Other items will also be needed for stationary computers. Monitors, computer mice, keyboards and speakers. Microphones and cameras can also be bought but will not serve much use. Laptops come with a keyboard, speaker, monitor, microphone and camera by themselves. A computer mouse could be bought with the laptop because they are more comfortable to use than trackpads.

The only concern about computers are proprietary boot firmware such as Intel ME and AMD PSP. This kind of software may have the capability of executing surveillance on the computer user. They are very difficult to remove or mitigate without specialized software. There are measures that can be taken to avoid this.

Libreboot is an alternative boot firmware that is free and open source. Libreboot can be used on specific Intel and AMD 86x computers. Most of the computers that can use Libreboot are cheap laptops which is good for guerrillas. Good laptops that can use Libreboot include the Lenovo Thinkpad X200, X60 and T400. All are very cheap and durable. A Gigabyte GA-G41M-ES2L can be Librebooted to make a stationary computer.

Get Libreboot here: <https://libreboot.org/>

Parts from AMD from and before the 15h architecture (Bulldozer) lacks AMD PSP from the start. From Intel 5 (i5) forwards Intel parts have the modern Intel ME. Old Intel ME is easy to disable with Libreboot. It will still be Librebooted for security. This hardware is from the early 2010's. There are other options if Libreboot is not used. Another option would be to buy a laptop by System76. This would be very expensive but would acquire a high quality and modern yet secure laptop.

Mobile phones

Mobile phones should not be used by guerrillas. They lack privacy. Mobile phones can monitor their surroundings even when turned off. Store mobile phones in aluminum foil if a recruit arrives with one during revolution or warfare. Aluminum foil blocks magnetic signals. Experiment: You will need a bluetooth speaker, a mobile phone and some tinfoil. Stream something from the mobile phone to the bluetooth speaker. Cover all of the mobile phone with aluminum foil. The signal to the bluetooth speaker will drop.

Do so even with Pinephones and Librem 5 mobile phones because of the SIM card. The only reason for guerrillas to have mobile phones would be to communicate during an operation from a distance with ease. The phones should be disposed of after the operation. They should be Android phones bought used from a stranger and then degoogled and rooted to make them less connected to the guerrilla.

Degoogling and rooting Android phones will make them much more secure. Do not degoogle or root the mobile phone with WiFi enabled or any connection to any Windows or macOS device.

Here are some websites for how to do that:

- https://old.reddit.com/r/MicroG/comments/hngcjq/guide_degoogle_any_device_and_install_microg/
- <https://forum.xda-developers.com/t/guide-degoogle-any-device-and-install-microg.4058743/>
- <https://www.xda-developers.com/root/>

And two forums if you are confused:

- <https://old.reddit.com/r/degoogle/>
- <https://www.reddit.com/r/androidroot/>

Operating Systems

The computer the guerrilla uses will run free and open source GNU/Linux operating systems. Never use proprietary operating systems such as Windows or macOS. GNU/Linux will be tedious to learn for Windows and macOS users but will be useful to know. GNU/Linux has many different variants called distributions or “distros”. These distros have different uses and themes. There are many distros that can be used. The writer of this document personally recommends Linux Mint as a daily-driver as it is easy to install, use and is very popular. It is acceptable to use other distros such as QubesOS, Fedora, Arch, Gentoo, and many more if you want to. QubesOS is security focused and may be experimented with. Just do not use Ubuntu. It has proprietary code.

To download and install GNU/Linux can be different depending on the distro utilized. The guide written in this section is for Linux Mint. You will need a computer running Windows, a USB flash drive, an ISO file of Linux Mint and Etcher.

Get Linux Mint: <https://linuxmint.com/>

Get Etcher: <https://www.balena.io/etcher/>

Connect the USB flash drive to the computer. Use Etcher with the Linux Mint ISO file and flash it to make a bootable USB flash drive. The ISO file is the “image”. This USB flash drive can be used multiple times to install Linux Mint. Restart the computer with the USB flash drive still connected. Repeatedly click the Escape, F1, F2, F8, F10, F11, F12 or Delete one at a time while the computer is restarting. The BIOS configuration screen will appear when doing so. Boot Linux Mint by selecting it and pressing enter.

Installing GNU/Linux will remove all of Windows. Make a backup of important files from Windows on a USB flash drive or a hard disk. Test the live session to ensure that the operating system runs acceptably. To install Linux Mint double click install Linux Mint. Choose the settings that you want and connect to the internet.

WARNING: Encrypt the new Linux Mint installation for security refers to full disk encryption. At this stage of the installation your keyboard layout wasn't yet selected so it is set to en_US. If you decide to use this option, keep this in mind when entering a password. Note that there are issues with this option and some NVIDIA drivers. If you are new to Linux use home directory encryption instead (you can select it later during the installation).

When the settings are finished the computer will be restarted. Remove the USB flash drive and use Linux Mint.

Another distro may be used if you prefer doing so. This distro is the daily-driver. The distro Tails will be used for more important information such as communicating operation plans and inventories with other guerrillas and researching illegal information. Tails will run a session and then wipe all information when the session ends. It comes in a USB flash drive that is booted into. Use etcher to flash a USB flash drive with the Tails ISO to prepare the operating system.

Get Tails: <https://tails.boum.org/>

Some people who do not know better recommend running Tails in a virtual machine. This is wrong. Tails run in a virtual machine will cause the activity on Tails to leave traces on the computer hard disk which it should not do. Virtual machines can be used for experimenting with operating systems. A good virtual machine is the free and open source Virtual Box.

Get Virtual Box: <https://www.virtualbox.org/>

Other Tech

There is lots of software, services and tips that can be used to make using a computer more comfortable and secure. All of the software written about here is open source unless specified otherwise.

Remember to use long and secure passwords and a different password for every service.

There are many browsers for viewing and interacting with websites on the internet. There are two browsers that the writer of this document would recommend: LibreWolf (based on Firefox) and ungoogled Chromium (based on Chromium). LibreWolf is automatically hardened Firefox. Ungoogled Chromium is Chromium without the properties that would allow surveillance. Enable HTTPS only mode on the browser.

Get LibreWolf: <https://librewolf.net/>

Get ungoogled Chromium: <https://github.com/Eloston/ungoogled-chromium>

You will need to use CRX extractor to get extensions on ungoogled Chromium. Here are three extensions that would be useful to add to the browser:

Get uBlock Origin: <https://ublockorigin.com/>

Get I don't care about cookies: <https://www.i-dont-care-about-cookies.eu/>

Get LocalCDN: <https://www.localcdn.org/>

Get extensions on ungoogled Chromium: <https://crxextractor.com/>

A search engine will be used in the browser. The most commonly used private search engine is DuckDuckGo. It is however rather clunky. Google users might use Startpage. It is a mirror of Google. Searx is another search engine. It is technically a metasearch engine: it compiles the results from other search engines. It is also fully open source and can be hosted by anyone. The link provided is a list of public instances. Some instances run the fork SearXNG which is also open source and good.

Use DuckDuckGo: <https://duckduckgo.com/>

Use Startpage: <https://www.startpage.com/>

Use Searx: <https://searx.space/>

Consider using secure software for other websites. Invidious is similar to Searx in that it has many instances and similar to Startpage in that it is a mirror of YouTube. Another site to consider is Anonym, which hides what website a user comes from. When clicking on a link the website will receive information about what the earlier website the user came from was. All that is done to use it is to take the link (<https://anonym.to/>) and then put the link of the website after it (<https://anonym.to/https://api.invidious.io>). This problem could also be avoided by opening a new tab and copy and pasting the link directly into it.

Use Invidious: <https://api.invidious.io/>

Use Anonym: <https://anonym.to/>

Most computers and USB flash drives the guerrilla handles should be encrypted in case they are stolen. VeraCrypt can encrypt hard disks, portions of hard disks like folders and USB flash drives. It also provides on-the-fly encryption. Encrypting a hard disk is not considered destruction of evidence in the USA.

Get VeraCrypt: <https://www.veracrypt.fr/en/Home.html>

BleachBit will be used after each operation if the status quo has not collapsed or if evidence must be destroyed. It will clean the entire machine and host. Check all all the checkboxes except for the "freospace" checkbox when doing so.

Get BleachBit: <https://www.bleachbit.org/>

GIMP, Krita, Tenacity, Blender and Shotcut can be used for producing propaganda. These programs are mostly useful if you are a propagandist. Note that Blender can be used as video editing software that is more complex than Shotcut.

Get GIMP: <https://www.gimp.org/>
Get Krita: <https://krita.org/en/>
Get Tenacity: <https://github.com/tenacityteam/tenacity>
Get Blender: <https://www.blender.org/>
Get Shotcut: <https://www.shotcut.org/>

Tor

Tor is a Firefox-based browser that highly anonymizes the user. It hides the user's IP. It should be used when researching or handling information that law enforcement and surveillance would note. It should be used at the safest protection level whenever possible. Tor is not useful for browsing websites such as YouTube. Many websites block Tor access. Tor can also access .onion websites. .onion domains are free to register and can be used to make secure websites for the guerrilla.

Tor works by using at least three Tor relays utilizing "onion routing". Each relay is independent of another, located in different regions and run by different people. Each relay the information goes through will peel off one layer of encryption. That is where the name "onion routing" comes from. The information is first encrypted with 3 layers of encryption. It then passes through the guard relay which knows the IP address of who sent the information but not what the information is. It peels off one layer of encryption and sends it to the middle relay. The middle relay peels off one layer of encryption and then the information either stays in the Tor network or enters the common internet. If the information is sent to a normal website (not .onion) it will be sent through the exit relay and peel off the final layer of encryption. The information will be fully unencrypted so that it can be read on the normal internet. It is advised to avoid sites on the normal internet when on Tor.

Tor can be used to host .onion domains. .onion domains are free but electricity and server maintenance will cost. Ensure that no important metadata is saved in the files that are uploaded to the .onion website. There are in depth instructions for how to set up a .onion service on the Tor website.

Get Tor: <https://www.torproject.org/>

Tor is very secure but has one major disadvantage: the exit node problem. As you can see, the information sent by 'Alice' in the image stays safe and encrypted just until the very end when it reaches 'Bob'. There is thus a minor risk for the deanonymizing of Tor users by the owner of an exit node. This is very dangerous when researching illegal information. Of course, the user could be outside at a bar or metro connected to a public WiFi while encrypted, but that will still leak an IP address to the general range of the user's home.

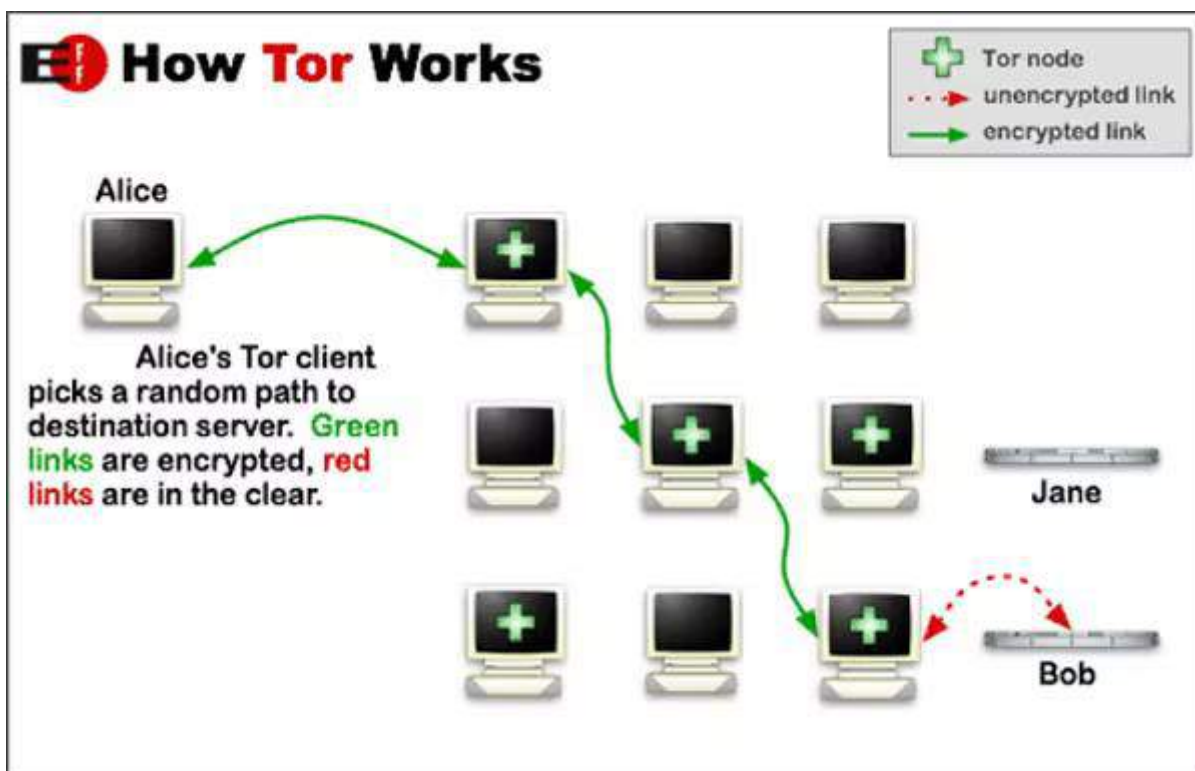

It is advised to instead get a VPN. If the exit node problem happens when using VPN → Tor, the hacker will get the IP to the VPN service's servers. The user then stays anonymous. The VPN used must follow these 5 rules:

1. The VPN does not store logs.
2. The VPN is not operated out of the USA. VPN services in the USA must give logs if police ask. Research the laws of other regions.
3. The VPN has a killswitch if the connection from the VPN drops.
4. The VPN has DNS leak protection.
5. The VPN can be paid for with cryptocurrencies.

A VPN that follows all of these rules is Mullvad, which costs 7 dollars a month. Mullvad can be paid for with Bitcoin, which is not very good and easily traceable. If possible, trade Monero for Bitcoin in a new wallet instead of buying Bitcoin directly. Monero is a much more preferable cryptocurrency with many more security features.

Get Mullvad: <https://mullvad.net/en/>

Communications

Communications facilitated with digital technologies are the quickest and most effective there are. They are also easily compromised if the guerrilla is not knowledgeable. This section will make the guerrilla knowledgeable in digital communications.

Do not use any common service for communication. They do not respect security. Guerrillas have multiple alternative options. The options that will be written about in this section Signal, Matrix, XMPP and Briar. Email will also be mentioned.

Signal

Instant messaging, voice calling and video calling. End-to-end encrypted. Free and open source. Easy to use. Hides who you talk to. The Signal foundation is able to retrieve information about account join date and last login. This is all information they will be able to give to law enforcement. The server software is mostly open source but the anti-spam component is proprietary. Uses standard cellular telephone numbers as identifiers. Registration requires a mobile phone but Signal client can be used on computers.

Get Signal: <https://signal.org/>

Matrix

Instant messaging, voice calling and video calling. End-to-end encrypted. Free and open source. Easy to use. Hides who you talk to. There are multiple clients that can be used for Matrix. Element is the most popular client. Server software is completely open source. Guerrillas should run their own isolated Matrix servers if possible. The official Matrix.org server can be used but not for guerrilla activities. Beware that metadata will accumulate after communications. The Matrix server should be reset sometimes. Warn every member about this in advance.

Fun fact: In April 2019, matrix.org suffered a security breach in which the production servers were compromised. This breach was not an issue with the Matrix protocol and did not directly affect home servers other than matrix.org.

Get Matrix: <https://matrix.org/>

XMPP

Instant messaging. End-to-end encrypted. Free and open source. Difficult to use. Hides who you talk to. There are multiple clients that can be used for XMPP. Server software is completely open source. Beware that metadata will accumulate after communications. The XMPP server should be reset sometimes. Warn every member about this in advance. Much older and has a stronger reputation than Matrix.

Get XMPP: <https://xmpp.org>

Briar

Instant messaging. End-to-end encrypted. Free and open source. Slightly difficult to use. Hides who you talk to. Briar requires no servers as it is peer-to-peer. It can be used without an internet connection with other signals. The limitation Briar has is its strongest reason to use: peer-to-peer communications. There can not be large server communities. People can only communicate when online. Messages can not be sent when the target is offline.

Get Briar: <https://briarproject.org/>

Here are two guides for setting up servers with Matrix and XMPP. They are slightly complex. Ensure that the guerrilla force has people competent with electronics.

Matrix servers

What you'll need to follow this tutorial:

- A self-hosted server DOH
- Docker and docker-compose (or use your own container runtime engine)
- Your own way of dealing with Let's Encrypt certificates and proxying. I am using traefik.
- A mail server
- DNS A Record: matrix.my.host: IP.OF.YOUR.SERVER
- DNS SRV Record: _matrix._tcp.my.host: 0 10 443 matrix.my.host

This is the docker-compose.yml I am using to run synapse, the matrix homeserver:

```
version: '3.3'
```

```
services:
```

```
  app:
```

```
    image: matrixdotorg/synapse
```

```
    restart: always
```

```
    volumes:
```

```
      - /var/docker_data/matrix:/data
```

```
    labels:
```

```
      - "traefik.frontend.entryPoints=http,https"
```

```
      - "traefik.port=8008"
```

```
      - "traefik.backend=matrix_app"
```

```
      - "traefik.frontend.rule=Host:matrix.my.host"
```

The image I am using is: matrixdotorg/synapse.

But before you can fire up this docker-compose file you'll need to first generate a configuration, as explained in their README.md

```
docker run -it --rm -v /var/docker_data/matrix:/data -e
SYNAPSE_SERVER_NAME=matrix.my.host -e SYNAPSE_REPORT_STATS=yes
matrixdotorg/synapse:latest generate
```

After generating the configuration, you can modify it at your will. Just go to /var/docker_data/matrix/homeserver.yaml and get your \$EDITOR going.

At last, fire up your instance with docker-compose up -d

Done? Not quite. Well the first thing I was missing after heading to https://matrix.my.host is a way to register my username.

Two ways of doing that:

- Set enable_registration: true in your homeserver.yaml and docker restart matrix_app_1

- `docker exec -it matrix_app_1 register_new_matrix_user -u myuser -p mypw -a -c /data/homeserver.yaml`

If setting `enable_registration` to true is used, be sure to set it back to false after registering your user if you do not want people to register on your homeserver.

Now go register a user on your preferred client.

Well this should work out of the box right? Well not exactly. We need federation to work, so we are able to join other channels on other homeserver and chat privately with people using other homeserver.

As explained in the docs, federation works by connecting to your homeserver through port 8448. But we do not want to make port 8448 publicly available, what now?

Also we are using a subdomain to make our matrix homeserver available (`matrix.my.host`) but we want our username to look like this: `myuser@my.host` and not like this: `myuser@matrix.my.host`.

Well there is a solution for these two problems:

In some cases you might not want to run Synapse on the machine that has the `server_name` as its public DNS hostname, or you might want federation traffic to use a different port than 8448. For example, you might want to have your user names look like `@user:example.com`, but you want to run Synapse on `synapse.example.com` on port 443. This can be done using delegation, which allows an admin to control where federation traffic should be sent. See `delegate.md` for instructions on how to set this up.

Taking a look at `delegate.md` explains quite a lot:

The URL `https://.well-known/matrix/server` should return a JSON structure containing the key `m.server` like so: `{ "m.server": "[:]" }`

Okay, so we set up a static file on our `matrix.host` under `.well-known/matrix/server` giving this JSON back:

```
{ "m.server": "matrix.my.host:443" }
```

and we are good.

The last thing we will need to do is start from scratch. Yes, we will delete all data under `/var/docker_data/matrix` and change the `base_domain` in our generate command:

```
docker run -it --rm -v /var/docker_data/matrix:/data -e  
SYNAPSE_SERVER_NAME=my.host -e SYNAPSE_REPORT_STATS=yes  
matrixdotorg/synapse:latest generate
```

This is needed, as we need to recreate keys and also users. Of course you could start right away with this, but I wanted to show all the modifications I had to do to get this thing

running. If you do not need federation however, and want to chat only to users from your homeserver, this step is of course not needed.

I also wanted to verify my mail address. I thought this would be fairly easy, just set up a mailaccount for matrix and configure it in your homeserver.yaml:

email:

```
smtp_host: mail.my.host
smtp_port: 587
smtp_user: "matrix@my.host"
smtp_pass: "thisisapassword!"
require_transport_security: true
notif_from: "Your Friendly %(app)s homeserver <noreply@my.host>"
```

Well not quite. There is a bug. Synapse only tries to use TLS1.0 and some mailservers may reject that, like mine. There is already an open issue to this problem. So I thought to myself: "Why not use a workaround?"

Just set up a second container, with a postfixforwarder in it, who will connect to my mail server using TLS > 1.0 and deliver the mails. Synapse can then connect to this docker container without auth and without TLS.

But please, be sure this container runs on the same server and is only accessible through the container network. We do not want to make port 25 of this container publicly available.

I used [juanluisbaptiste/postfix](#) for this.

After modifying my docker-compose.yml:

```
version: '3.3'
```

services:

```
app:
  image: matrixdotorg/synapse
  restart: always
  volumes:
    - /var/docker_data/matrix:/data
  labels:
    - "traefik.frontend.entryPoints=http,https"
    - "traefik.port=8008"
    - "traefik.backend=matrix_app"
    - "traefik.frontend.rule=Host:matrix.my.host"
```

postfixfwd:

```
image: juanluisbaptiste/postfix
restart: always
environment:
  - SMTP_SERVER=mail.my.host
  - SMTP_USERNAME=matrix@my.host
  - SMTP_PASSWORD=thisisapassword!
```

- SERVER_HOSTNAME=postfixfdw.my.host

and of course the homeserver.yaml:

email:

```
smtp_host: matrix_postfixfdw_1
smtp_port: 25
# no authentication needed
#smtp_user: "matrix@my.host"
#smtp_pass: "thisisapassword!"
#require_transport_security: true
notif_from: "Your Friendly %(app)s homeserver <noreply@my.host>"
```

I just had to restart synapse again and after that fire up the postfix forwarder container:
docker-compose up -d

Now I was able to send mails through my matrix server and verify my mailadress.

I am the only user on my matrix homeserver, but am able to join matrix.org chat rooms. I recently started chatting with appservice-irc:matrix.org too. This bot enables you to join IRC chat rooms on the freenode.net network.

Some useful commands there:

```
!help
!join #myroom
!listrooms
```

This is very useful, as I can easily follow up on IRC with my smartphone.

XMPP servers

The server I'll be discussing today is Prosody. It's very minimal so it won't take up much space and you'll be able to get it set up in under 10 minutes. For all of the steps you can check out my video (<https://invidio.xamh.de/watch?v=67QxJSI-ZMs>) for further explanation.

So the first thing you'll need is a domain name and a server. Once you know that your domain is pointing to your servers IP address you can install the Prosody package. I'm on Ubuntu so I'll be using APT but check the documentation for whatever OS your server is running. If you're on Ubuntu like me simply run the below instruction.

```
sudo apt-get install prosody
```

Next you'll need an SSL certificate for your domain. If you have HTTPS already then you can skip this. Simply install Letsencrypt and run the command to set it up.

```
sudo apt-get install letsencryptsudo letsencrypt -d <Your Domain Name>
```

Next you'll need to add both the key-chain and the private key to a single file. Then the prosody CLI will be able to handle it. To do this simply run the below command.

```
sudo sh -c 'cat /etc/letsencrypt/live/<YOURDOMAIN>/privkey.pem
/etc/letsencrypt/live/<YOURDOMAIN>/fullchain.pem > key-and-cert.pem'
sudo prosodyctl --root cert import key-and-cert.pem
sudo rm key-and-cert.pem
```

That's the bulk of your setup done. The only other thing to do is to edit a line in the config file and add your users. The config file is at the location `/etc/prosody/prosody.cfg.lua` and you'll need to change VirtualHost "example.org" to your domain.

```
VirtualHost "YOURDOMAIN.com"
```

Then you can finally add your user using the CLI command. The format is you need to specify your `username@yourdomain` .

```
sudo prosodyctl adduser me@example.com
```

There you have it. In just a few commands you'll have your very own private chat server and you'll be able to re-use the domain for your website. To connect simply download an XMPP client for your phone or computer. If your on Android you can use the app "Conversations" and if you're on IOS you can use "Monal".

Email

Email should not be used for communications but can be used for registration. Ensure that communication executed via email is encrypted with GnuPG. Throwaway emails are a useful tool for making communities online.

For general purpose usage Tutanota is the best free email. It is end-to-end encrypted and is very reliable. The software used to run Tutanota is open source. Tutanota can only be used on its website and can not be used with email clients. Always post with encryption. Be active with Tutanota. Remove inactive accounts.

Sign up on Tutanota: <https://tutanota.com/>

Gmail is very good for registering accounts. It is free and accepted by every website. It is also easy to make accounts with. One account can be used to make multiple accounts for the user's "children". These accounts are slightly limited but can be used for registrations on most websites. Gmail should never be used for communications.

Create a fodder email address: <https://mail.google.com/mail>

Temporary email addresses can also be used on smaller websites. Temporary email addresses are also a secure method to communicate in short sessions with news media or to make a bomb threat. Refreshing the page creates a new email address and removes the earlier address. Guerrillamail is the most reliable and trusted temporary email service.

Use Guerrillamail: <https://www.guerrillamail.com/>

Cryptocurrency

Cryptocurrencies are a good alternative for fiat currencies on the internet and can be bought and sold for profit similarly to the stock market. Popular cryptocurrencies such as Bitcoin and Ethereum are not private enough. Monero is recommended. Interactions made with Monero are untraceable as of 2021. The United States Internal Revenue Service (IRS) has posted bounties for contractors that can develop monero tracing technologies. None have made effective and reliable methods.

Monero can be used for buying items and services anonymously, securely demanding ransoms, hiding the amount of wealth of a guerrilla from surveillance and tax agents, securely transferring large amounts of money and securing that the identities of citizen supporters who donate to the guerrilla organization remain anonymous and secure from law enforcement.

Learn more about Monero: <https://www.getmonero.org/>

Dissemination

This section will concern how to disseminate files and other information to the public over the internet. The majority of dissemination will not be executed by guerrillas. It will instead be handled by the unarmed supporters of guerrillas such as propagandists, influencers and (if the guerrilla movement becomes powerful enough) scholars. The most powerful demographic are supportive citizens. They will influence their friends, family and coworkers for free and without the struggles of the propagandist. Supportive citizens may send each other relevant files and information over social media, internet forums and messaging applications.

Propaganda and information disseminated on social media should be of a lighter tone than that disseminated in small forums. Websites such as YouTube, Facebook, Twitter and Instagram which are populated by potential target communities are actively censored by their administrators and law enforcement. People uneducated about the guerrillas' cause may also be shocked by the information supporting assassinations and warfare against the status quo. The average person has been educated that violence is never acceptable against the status quo and that ideologies against the status quo are evil. How does the average person think of your ideology? Not very favorably.

The main communities that should be targeted are those filled with people who are alienated by society but show the capability of proper work and intelligence. People who are alienated by society but do not have any abilities should be swayed out of the community. This includes public sexual deviants, drug addicts and hyper-consumerists. These individuals may be accepted into the community proper if they change their ways. Online video games are semi-reliable but many people there have no abilities. The best communities to target from are small hobby and interest groups which require a higher intellect and embrace autonomy.

It is advised to not recruit converted individuals from the internet. They should instead be advised to start recruiting people themselves from small real life groups if groups need to be formed. These intimate groups will be much harder to infiltrate and will prop up all

around the nation if internet activity is effective. These groups may operate their own servers for communications. There are multiple good websites that will store most files:

- <https://anonfiles.com/>
- <https://archive.org/?noscript=true>
- <https://dropmb.com/>
- <https://gofile.io/>
- <https://www.justbeamit.com/>
- <https://mega.io/>
- <https://sendfileonline.com/>
- <https://www.swisstransfer.com/>

Another option is to torrent the files. The magnet link to the torrent will provide the file as long computers of the file seed. Any computer with an internet connection and the file can seed. The problem is that the seeding computer's and the leeches' (the people who torrent the file but do not seed it) IP addresses will be revealed. This can be avoided by using a VPN.

Honeypots

Law enforcement hates the concerned citizen and especially hates the guerrilla and will make traps to catch them. These traps are honeypots. Honeypots are programs, services and contacts that would be of interest to a set group but is used to for the surveillance of that group. Honeypots have been used to identify terrorists, hackers, pedophiles and you yourself if you do not think about what you will be using!

Before using something that could be a honeypot ask yourself these three questions:

1. Is it popular? Popular things have extensive documentation and communities interested in the topic.
2. Is it open source? Open source things can be analyzed for malicious code and open source projects that are popular will have this code exposed very quickly if there is such code.
3. Who is the target audience? Most privacy respecting things are targeted to privacy concerned individuals. Honeypots are often targeted directly to hackers, criminals, etc.

An example would be ANOM:

1. No. ANOM was unheard of before the crackdown.
2. No. ANOM was proprietary.
3. Criminals.

ANOM lead to a crackdown which arrested 800 suspects in 16 countries along with 40 tons of drugs, 250 firearms, 55 luxury cars and 148 million dollars in currencies and cryptocurrencies. Do your research! Here is an example of an internet user who researched ANOM before the crackdown and exposed it as a scam:

<https://web.archive.org/web/20210610004653/http://webcache.googleusercontent.com/search?q=cache%3Ahttps%3A%2F%2Fanomexposed.wordpress.com%2F2021%2F03%2F29%2Fanom-encrypted-scam-exposed%2F>

LAST TIP: Disable auto-update features on all software. Only update after researching the new update. Hackers and law enforcement could hijack the software developers. Thus also avoid modern video games (which may be tools of surveillance) and applications such as Steam which are proprietary. Steam should not be used on the private computer used for communications and important information. If you really want to have video games on the private computer then use emulators and safe ROMs.

CHAPTER VI: EXPLOSIVES

First some basic safety rules:

- 1) Don't smoke! (don't laugh- an errant cigarette wiped out the Weathermen). Avoid open flames, especially when working with flammable liquids or powdered metals.
- 2) Grind all ingredients separately. It is alarming how friction sensitive some supposedly safe compositions really are. Grinding causes heat and possibly sparks, both of which can initiate an explosion.
- 3) Start with very small quantities. Even small quantities of high explosives can be very dangerous. Once you have some idea of the power of the explosive, you can progress to larger amounts. Store high explosives separately from low explosives, and sensitive devices, such as blasting caps, should be stored well away from all flammable or explosive material.
- 4) Allow for a 20% margin of error. Never let your safety depend on the expected results. Just because the average burning rate of a fuse is 30 secs/foot, don't depend on the 6 inches sticking out of your pipe bomb to take exactly 15 seconds.
- 5) Never underestimate the range of your shrapnel. The cap from a pipe bomb can often travel a block or more at high velocities before coming to rest- If you have to stay nearby, remember that if you can see it, it can kill you.
- 6) At the least, take the author's precautions. When mixing sensitive compounds (such as flash powder) avoid all sources of static electricity. Work in an area with moderate humidity, good ventilation, and watch out for sources of sparks and flame, which can ignite particles suspended in the air. Always follow the directions given and never take shortcuts.
- 7) Buy quality safety equipment, and use it at all times. Always wear a face shield, or at the minimum, shatterproof lab glasses. It's usually a good idea to wear gloves when handling corrosive chemicals, and a lab apron can help prevent life-threatening burns.
- 8) Understand explosive categories: primary explosives can be set off by friction, shock, or fire. Secondary (booster) explosives need primary explosives as detonators. Tertiary (bulk) explosives need secondary explosives as booster to be detonated.

The best way to mix two dry chemicals to form an explosive is to do as the small-scale fireworks manufacturer's do:

Ingredients: 1 large sheet of smooth paper (for example a page from a newspaper that does not use staples), and the dry chemicals needed for the desired compound.

- 1) Measure out the appropriate amounts of the two chemicals, and pour them in two small heaps near opposite corners of the sheet.
- 2) Pick up the sheet by the two corners near the powders, allowing the powders to roll towards the middle of the sheet.
- 3) By raising one corner and then the other, roll the powders back and forth in the middle of the open sheet, taking care not to let the mixture spill from either of the loose ends.
- 4) Pour the powder off from the middle of the sheet, and use it! If it must be stored use airtight containers and store away from people, houses, and valuable items.

Match-heads

Match-heads are highly flammable, but not technically explosives. They are also very sensitive to friction, so it is not advised to use match-heads. Powdered match-heads can be mixed with some powdered sugar to make them slightly more powerful. Powdered match-heads are powerful enough to use for pipe bombs, although they will absolutely not be ideal.

The match-heads will have to be crushed into a fine powder for the most optimal detonation. From time to time, a match tip will burst into flame while you are in the process of cutting off the match-head. When that happens, as it will, it is important that only the one tip ignites – that it doesn't fall into a pile of others previously removed.

To crush, place three to five tips on a sheet of paper on a hard surface. Make three piles. In one corner, keep the tips you have not yet started to crush. That's your raw material. In another corner, keep the crushed-up powder you have just made. That's your finished goods. The actual crushing takes place in the center, one tip at a time. That's your work-in-progress.

In crushing, use the cutting edge of a knife to cut each tip in half, then in quarters, then dice into a fine powder. From time to time a match tip will ignite, especially on the first cut when the pieces are still large. If you work with three piles – raw material, finished goods, and work-in-progress – the worst that can happen is that one tip ignites and burns a hole in the paper. The other way to do it, crushing several tips at once, is asking for trouble.

Use small pieces of paper for funnels, scoops, and pushers. When dealing with a very fine powder, some problems will be encountered with static electricity. Some individual particles will be repelled and you will have to chase them around to pick them up.

The modern strike anywhere match contains a small quantity of phosphorus trisulfide at the very tip. This is a primary explosive, sensitive to both friction and impact. When the match tip is lit, it ignites, in turn, the main body of the match head.

The phosphorous trisulfide tip (the white part in Diamond brand matches; the light blue part in Ohio Blue Tip) is important because it can be used in detonators. The rest of the strike anywhere match-head is ill-fit for detonators or primers.

Nitroglycerin

Nitroglycerin is an extremely sensitive primary explosive and one of the most powerful explosives all in all. It must be stabilized and diluted for safety reasons. Sulfuric acid can be concentrated by boiling it for a while so that the other stuff evaporates.

Other than nitric acid, the only tricky material to get a hold of is glycerin (also known as glycerol). It can be bought in pharmacies and grocery stores as 'skin protectant' and in beer breweries as the 'thickening agent'. Most ideal is pure glycerin, which can be bought in some pharmacies. Buying it online from certain wholesalers however is cheaper. Pharmacies sell glycerol at a mark up like with many other pharmaceutical products.

Materials Required:

- Nitric acid.
- Ice.
- Concentrated sulfuric acid.
- Thermometer.
- Sodium bicarbonate.
- Glycerin.

Note: the amounts of each material listed is the suggested amount by a university. More materials should be used when properly manufacturing nitroglycerin.

1. Cool 13 mL of nitric acid using the ice created by the refrigerator.
2. After it has cooled, add to 39mL sulfuric acid (99% H_2SO_4), mixing very slowly.
3. Cool the new mixture to 10-15°C, which we can measure with the thermometer already in it.
4. Slowly add enough glycerin to cover the entire surface of the acid, or more. The glycerin will be nitrated and turned to nitroglycerin soon.
5. Keep the solution below 30°C.
6. Stir gently for ten minutes, then the nitroglycerin will form as a layer on top of the acid solution, while the sulfuric acid will absorb the excess water.
7. Filter out the nitroglycerin and place it in sodium bicarbonate, which will neutralize much of the acid remaining. This will help to stabilize it. The acid solution may be reused.
8. Now slowly and carefully remove the nitroglycerin from the bicarbonate. The usual test to see if nitration has been successful is to place one drop of the nitroglycerin on metal and ignite it. If it is true nitroglycerin it will burn with a clear blue flame.

The chemical reaction going on here is: $\text{C}_3\text{H}_5(\text{OH})_3 + 3\text{HNO}_3 + \text{H}_2\text{SO}_4 = \text{C}_3\text{H}_5(\text{NO}_3)_3 + 3\text{H}_2\text{O} + \text{H}_2\text{SO}_4$.

Acetone added to nitroglycerin operates in a desensitizing manner. The following table summarizes the change in sensitivity for various nitroglycerin / acetone mixtures, given in detonation drop height, for the 2 kilogram weight used in the Bureau of Mines impact test:

Nitroglycerin.	Acetone.	Impact height.
100%.	0%.	16 cm.
90%.	10%.	23 cm.
80%.	20%.	41 cm.
75%.	25%.	60 cm.
73%.	27%.	64 cm.
70%.	30%.	100 cm.

Dynamite

Dynamite is an explosive made of nitroglycerin, an adsorbent (usually diatomaceous earth, which is sold as 'insect killer') and various stabilizers. It is the first high explosive developed, and it replaced gunpowder in many applications. It is the most stable use of nitroglycerin, although a detonator will be needed to detonate dynamite, unlike normal nitroglycerin (which is a primary explosive).

Dynamite can be prepared by carefully adding nitroglycerin to powdered diatomite and allowing it to slowly adsorb in the diatomaceous earth. Working with dynamite will result in absorbing nitroglycerin liquid/vapors, which, being a strong vasodilator, will result in severe headaches. Wear the proper attire! Dynamite is best stored in cool places. It can only be stored safely for about 1 year. Over time, it will "sweat" nitroglycerin, which is very dangerous.

Dynamite is usually rated by "weight strength" (the amount of nitroglycerin it contains), usually from 20% to 60%. For example, 40% dynamite is composed of 40% nitroglycerin and 60% "dope" (the absorbent storage medium mixed with the stabilizer and any additives).

TATP

Triacetone Triperoxide (TATP), often referred to as "acetone peroxide," was the primary explosive used in the Brussels attacks which killed 35 and injured over 300 in 2016. It is relatively simple to make from commonly-available ingredients. It is an entropy burst explosive, releasing massive amounts of fast-moving gas as its internal structure collapses.

TATP is very popular among Jihadi terrorists and probably the easiest compound to manufacture (although Hydrogen Peroxide is increasingly harder to acquire due to EU anti-terror laws). I only found one single UK supplier on Ebay for the 30% liquid. However, it is highly advised to not manufacture TATP as it is EXTREMELY unstable (sensitive to friction and shock). It is a 40% probability that you will end up blowing yourself up.

- Acetone (sold as paint thinner).
- Hydrogen peroxide (hair bleach type – 15 volume or higher – hair/cosmetics store, preferably 30% liquid).
- Sulfuric acid (concentrated; if you use battery acid, boil until white fumes appear to remove all of the water).
- Thermometer.
- Ice.
- Salt.

Note: the amounts of each material listed is the suggested amount. More materials could be used when manufacturing TATP if you are feeling suicidal.

Combine 30 milliliters of acetone and 50 milliliters of hydrogen peroxide into a glass container and mix thoroughly.

The container must now be put into ice/salt water and cooled to below 5 °C. The easiest way to do this: take a coffee can, put in water and salt to about half full, put container (empty) into can, put plastic lid on can to keep container from floating, put can in freezer, when water is frozen, take out, remove lid, proceed. This will provide excellent cooling and also keep container from floating.

Now, put a thermometer in the mixture. When it is below 5 °C, start putting in the sulfuric acid, one drop at a time. Keep stirring and watching the thermometer. Adding the acid

produces heat; if it gets up to 10 degrees, stop adding acid and wait for it to cool. You need to add a total of 2.5 milliliters of sulfuric acid, one drop at a time.

What happens if the temp gets significantly higher than 10 degrees? I don't know, because I never let it happen. Keep the temperature down. Also watch the acid, as it tends to splatter.

Keep stirring for a couple minutes after adding all the acid. Put the container in the fridge (not freezer) and let it sit overnight. When you get it out the next morning, there will be a white precipitate on the bottom.

Pour the solution through a coffee filter, paper towel, or other filtering paper. This will collect the precipitate. Pour a couple of spoonfuls of ice-cold water through the towel to remove acid. Now set the paper out to dry. The resulting powder/crystals are a very powerful primary explosive. Keep away from shock, friction, and flame.

This material can be loaded into a 2.5 inch length of brass or copper tubing and pressed down to make blasting caps. The pressing may be hazardous. This type of blasting cap will detonate most homemade explosives without a booster explosive: TATP is a very powerful initiator and can be used by itself as the main filler when making homemade detonators.

This is the explosive of choice — called the “Mother of Satan” by some terrorists — of those who are attacking targets in Europe. All of its ingredients are easily obtained, and the process of making it is simple and (relatively) stable. In other words, the European law enforcement and intelligence cannot stop it from happening.

Mercury(II) Fulminate

Mercury fulminate is a primary explosive that had its industrial beginnings in 1867. Alfred Nobel took out a British patent on the blasting cap, its use and makeup. His first blasting caps were simple ones very similar in many ways to the one in this book. Mercury fulminate was chosen out of a field of explosive fulminating compositions. This was mainly due to the stability that could be obtained and the ability to lend its self to commercial manufacture at that time. Of course, the primary explosives used today are much superior to mercury fulminate. Mercury fulminate is not good for storage at elevated temperatures over 6-12 months. Five years in the magazine could disable caps. It is a good choice for clandestine manufacture. It would also be a very good choice for electric cap manufacture. The drawbacks would be the poor elevated temperature storage and the toxic nature of mercury and subsequent problems in loading.

Very popular among recreational users. This compound is noticeably more stable than TATP but still carries a relative risk as it is unstable and sensitive to friction, shock and even to static electricity. 5 times more safe than TATP.

Note: the amounts of each material listed is the suggested amount. More materials could be used when manufacturing mercury(II) fulminate if you are feeling suicidal.

- Distilled water.
- Elemental mercury.
- Nitric acid.

- Everclear (90%).

In a pint large mouth fruit jar or 500 ml beaker place either 2 ml water and 10 ml 90% + nitric acid. Water first of course. If 70% nitric acid is available then place 11.5 ml of it instead of the 90% in the pint jar. Add 1 1/4 gram of elemental mercury.

CAUTION: Mercury fulminate manufacture generates fumes that are poisonous and this whole procedure should be done with very good ventilation.

CAUTION: The fumes produced are poisonous and flammable and they should be avoided as well as flame should be kept away as fumes are highly flammable too!

The mercury in the bottom of the jar should begin to bubble. If not add water drop wise to the solution until it does. A vigorous effervescent reaction takes place and red fumes are produced. They should be avoided as they are very poisonous. The mercury will all dissolve in the solution. If not heat gently but from a remote position until it does. After it is dissolved let it cool somewhat. Warm 90 cc of ethanol (90%+, "Everclear") in a quart jar. Add the solution to this ethanol. The reaction should start within 5 minutes. The fumes put off by this mixture should be avoided. When the reaction is complete the fumes will have subsided and a gray powder will have settled to the bottom. That powder is mercury(II) fulminate.

CAUTION: The mercury(II) fulminate is to be kept away from shock, friction and flame or heat! Contact with the crystals should be avoided as the free mercury still poses a health problem!

Filter the gray powder out of the liquid. These gray mercury(II) fulminate crystals should be washed with 60 ml ethanol. Allow the crystals to dry by spreading them out gently. These dry mercury(II) fulminate crystals are then ready to use. This explosive can safely be stored under water and these crystals could be mixed with 200 ml distilled water and stored until needed.

DDNP

When creating a blasting cap it is recommended that you choose DDNP (diazodinitrophenol) as it is significantly less sensitive than mercury(II) fulminate and TATP, yet still sensitive enough to effectively initiate all boosters and many secondary explosives. It still carries HIGH risk as it is unstable and sensitive to friction, shock and to a degree static electricity. 10 times more safe than TATP. The charge however must be a minimum of 6 grams and confined in order to detonate properly.

If I had to choose a compound in which to produce I would select DDNP first, then either mercury(II) fulminate or HMTD.

The diazodinitrophenol must be dried before it will explode. Drying will take 24 hours if done at room temperature, or in 2 hours if the crystals are placed in a beaker suspended in hot water. The diazodinitrophenol must be stored in a sealed glass container. Storing the explosive moist, about 25% water, will increase safety. Dry immediately before use. Do not store this material dry for long periods of time. For storage, store submerged in water-free

kerosene in tightly sealed amber glass bottles away from light. DDNP is desensitized by immersion in water.

It decomposes when exposed to direct sunlight and explodes violently when heated to 150 C. Detonates easily by sparks, fire, percussion or friction. It can be compressed substantially without detonation or decomposition and compressed samples can still be easily detonated. DDNP is less sensitive than mercury fulminate and has a greater detonating velocity.

4 guides for synthesizing DDNP will be written about.

Guide 1: DDNP or dinol, which stands for Diazodinitrophenol, has a reputation of being one of the best primaries out there when it comes to performance. Its synthesis is often disregarded because few people have gotten it to work. It has a very high stability considering it's a primary. The only downside to this is that some of the chemicals needed for the procedure are hard to find or must be synthesized. The synthesis actually has a lot of reactions going on throughout it. It is mainly two parts; preparation of sodium picramate, then diazotation of picramic acid. I have actually gotten this procedure to work, and I am satisfied with my product.

$C_6H_3N_3O_7 + NaOH \rightarrow C_6H_2N_3O_7Na + H_2O$ (Picric acid neutralized to sodium picrate).

$S + NaOH \rightarrow Na_2S_x$ (Sodium Polysulfide)

$C_6H_2N_3O_7Na + \text{Reducing compound} \rightarrow C_6H_4N_3O_5Na$ (Sodium picrate reduced to sodium picramate).

$C_6H_4N_3O_5Na + H_2SO_4 \rightarrow C_6H_5N_3O_5 + NaHSO_4$ (Sodium picramate acidified into picramic acid).

$C_6H_5N_3O_5 + HNO_2 \rightarrow C_6H_3N_4O_5$ (picramic acid diazotized).

Materials:

- Picric Acid (see the table of contents, as there is another guide for making picric acid which is required for DDNP).
- Sodium Hydroxide (compound which you will create from sub-materials).
- Glass funnel.
- Sulfur 1000ml beaker.
- Sulfuric Acid Ice bath and equipment.
- Sodium Nitrite - 200ml evaporating dish.
- Acetone (150 ml per batch, so 500-1000 ml should be enough), used to mix with semi pure DDNP, and then filter, and then evaporate in dish to create pure DDNP. 250ml beaker.

1. Into a 600ml beaker, pour 100mls of water and heat up to ~70-80 °C.

2. Add 9 grams of finely powdered picric acid to this and swirl it a little bit. It will not all dissolve however, so don't assume you're getting anywhere by swirling it for 24 hours.

3. Now we add 1.5 grams of sodium hydroxide to this. Swirl this mixture around until everything inside dissolves. Yes it will all dissolve just keep swirling. The solution will turn to an orangish color. This is a sodium picrate solution. Keep this on low heat and add water as it evaporates.

4. In another beaker, pour 300mls of water and 8.0 grams of sodium hydroxide. Bring the solution to a rolling boil.

5. Measure out 7.5 grams of pure sulfur, and crush it finely. Sieve it into the boiling sodium hydroxide solution making sure to get as little sulfur on the sides of the beaker as possible. Let this boil for 60-120min (1 to 2 hours), adding water as necessary. After this amount of time, most if not all of the sulfur should be dissolved. If you sit and watch it the whole time, you will notice a color change from clear to green to blue, to puke green, to pea green, then to a very dark color and once all the sulfur dissolves it will be a very very dark red color. Set this on a towel or similar device and let it cool down until it stops boiling. The reason for the towel is so that it doesn't come in direct contact with any room temperature (or colder) surface.
6. Once it stopped boiling (but is still hot) add it to the sodium picrate solution in the other beaker, in 4 portions.
7. Once all of it is added, place the beaker in a refrigerator (about 4 °C) until its cold. There should be a healthy amount of red crystals in the bottom of the beaker.
8. Filter the whole solution into the 600ml beaker that was used in the last step. Discard the filtrate and clean that beaker out.
9. Pour 300mls of water in it and bring it to a boil. Add the red crystals in the filter (and everything else) to the boiling water and boil it for 2-3 minutes. While it is still boiling clean out the other 600ml beaker which should be empty.
10. Filter the boiling solution into the clean 600ml beaker. Discard the filter and its contents and let the filtrate cool to room temp. This is now a sodium picramate solution.
11. When the sodium picramate solution is at room temp, drip concentrated sulfuric acid in there with stirring. Keep dripping it in there until it just barely tests acidic on litmus paper. This will take 1-2ml. You will also notice that the color has changed from a deep red color to a sort of rusty color. There is also a precipitate in the beaker (and a lot of it). This is picramic acid.
12. Measure out 7.5 grams of sulfuric acid and add it to this beaker. Mix the beaker up, then pour it into a 1000ml beaker. Add another 100ml of water to this.
13. Place this beaker in an ice bath and bring the temperature down below 5 °C.
14. In another 600ml beaker, pour 250ml of water and add 5.4 grams of sodium nitrite. Swirl it until its dissolved.
15. Now, slowly add this solution to the picramic acid solution in the 1000ml beaker, keeping the temperature below 5 °C. Be sure to stir almost constantly during this part. You can stop stirring if you're not adding anything if you need a break though. Once all of it is added, continue stirring for a couple more minutes then remove it from the ice bath. Let it slowly warm up to room temperature. You will see a brown precipitate (the shade of brown varies sometimes).
16. Once it is up to room temperature, filter the solution out. There is a lot of DDNP crystals in here, so use two different filter papers. Try to even the amounts of DDNP on each filter paper when filtering.
17. Once all the crystals are filtered out, run 60ml of cold water through each filter to wash out some of the very soluble products. Remember, DDNP is slightly soluble in water so make sure it's cold.
18. Scrape the DDNP on the filter papers into a 250ml beaker. Add acetone to this, 100-150ml should be fine to dissolve all the DDNP. Swirl it around good to dissolve as much as possible. There will be a significant amount of impurities that are undissolved which should be yellow; the solution should be brown.
19. Filter this solution out into a 200ml evaporating dish. Discard the filter and the contents of it. Place the 200ml evaporating dish on top of a 1000ml beaker with boiling water in the bottom of it. Keep boiling the water so that the steam boils away the acetone (do this

outside or with good ventilation). Eventually you will be left with a brown crystal in your evaporating dish. This is pure DDNP.

DO NOT SCRAPE THIS STUFF OFF THE EVAPORATION DISH. Get as much as you can of the loose crystal, but don't scrape at the layer stuck to the evaporating dish because this compound is friction sensitive. The yield I achieved was 3.7 grams. This is a poor yield mainly because I lost a lot during purification because a filter paper ripped open (I know, I know; excuses excuses).

Guide 2: Chemicals:

- Sodium hydroxide.
- Picric acid.
- Sulfur.
- Sulfuric acid (concentrated).
- Potassium or sodium nitrite.
- Distilled water.

Materials:

- 4 x 500 ml glass beakers.
- 2 x Glass stirring rod.
- Filter papers.
- Heating source.

MANUFACTURE:

1. Mix in a beaker 90 ml warm water and 1.5 grams of sodium hydroxide until all NaOH is dissolved.
2. Stir in carefully 9 grams of picric acid in the above solution. Name it solution 1.
3. In the second beaker fill 300 ml water. Stir in 7.5 g of Sulfur and 7.5 g of Sodium Hydroxide/NaOH. Boil this solution over a heating source. After a few minutes of boiling, the solution turns red. Allow to cool. Name it solution 2.
4. Add solution 2, under stirring, in three portions to solution 1 and allow to cool.
5. Filter the solution through coffee filter. Small red crystals should form. Discard the liquid.
6. These red crystals are added to 180 ml of boiling water. Filter hot. Discard the crystals collect in filter paper, and name the liquid solution 3.
7. Slowly and drop by drop add concentrated sulfuric acid to solution 3 until the solution turns orange-brown.
8. Add to the orange-brown solution 7.5 g of sulfuric acid.
9. In 2nd beaker dissolve 5.4 g of potassium or sodium nitrite in 240 ml of water. Name it solution 4.
10. Solution 4 is added in one portion to soln. 3 under well stirring.
11. Let mixture sit for ca 10 minutes. Filter the now brown solution (pure DDNP) through a paper. The crystals left are washed with 60 ml water. Let dry for 24 hours. DDNP is best stored with 25% water. Load moist in detonator.

Guide 3: Picric acid 6 g.

Sodium Hydroxide 6 g (Lye – caustic soda).

Sulfur 5 g.

Sulfuric acid 120 ml.

Sodium nitrite (not nitrate).

Distilled water.

Boiling water.
Distilled ice water.

Diazodinitrophenol is a greenish yellow to a brown crystal and is superior to mercury(II) fulminate as a detonating agent. To make it:

1. Dissolve 1 g of sodium hydroxide in 65 ml of distilled water
2. Then add 6 g of picric acid to the lye solution.
3. In another container put 10 ml of distilled water and add 5 g of Sulfur to the water.4. Now add 5 g of sodium hydroxide to the sulfur/water. Boil this mixture until it turns bright red. Let the solution cool off.
5. Add the sulfur/lye to picric acid solution in four portions letting the picric solution cool down in between additions. Stir the solution while adding the sulfur/lye.
6. Let the mixture cool off then filter out the red particles.
7. Dissolve the red particles in 130 ml of boiling water. Filter the solution and discard any precipitate, save the solution.
8. Add 80% sulfuric acid to the solution drop by drop until it turns an orange-brown color then add 15 ml more sulfuric acid. Let the solution cool down to room temperature.
9. Dissolve 3.75 g of sodium nitrite (not nitrate) in 150 ml of distilled water.
10. Add the nitrite solution to the orange-brown solution all at once while stirring. Let the solution stand for 10 - 15 mins. The solution should be a brown color.
11. Filter out the particles of DDNP and wash them with 100 ml of distilled ice water. Store the DDNP under a small amount of water until use.

Guide 4: Its preparation is very simple, needing only picramic acid, sodium or potassium nitrite, and some dilute hydrochloric or 85%+ sulfuric acid. Obtaining the picramic acid will be impossible for most, so I included how it can be prepared in the synthesis section. Diazodinitrophenol is prepared by a diazotization reaction, this happens when an amine substituent, NH₂, on an aromatic ring, loses its hydrogen atoms and forms a triple bond with another nitrogen atom.

1. Place 120 mL of 5% hydrochloric acid in a 250-mL beaker
2. Then immerse the beaker in a salt-ice bath. Place the ice bath on top of a magnetic stirrer and drop a spin bar in the beaker.
3. Slowly add 10 g of picramic acid to the acid solution while stirring rapidly, monitor the temperature with a thermometer. Be sure there is no sudden rise in temperature. If you do not have a magnetic stirrer, use a stirring rod and stir like the wind.
4. Dissolve 3.6 g of sodium nitrite in 10 mL of water.
5. After the picramic acid has dissolved, add the sodium nitrite solution all at once and continue stirring for 20 minutes.
6. Filter the solution to collect the dark brown crystals that should have formed and wash them with cold water. The diazodinitrophenol thus formed can be used as is, or it can be purified by dissolving in hot acetone then precipitated by adding a large volume of ice water while rapidly mixing the liquid. This treatment will convert the diazodinitrophenol into bright yellow crystals. You will need a graduated cylinder for measuring liquids.

HMTD

HMTD (Hexamethylenetriperoxidediamine) is a high performance primary explosive. It is one of the better initiating explosives but has some definite drawbacks. HMTD is not stable

at even slightly elevated temperatures. Room temperature will even cause a decrease in performance with storage time. As one would imagine, due to the extreme excess of oxygen, the corrosion of metals in contact with the peroxide is a problem. The metals that will cause problems are aluminum, zinc, antimony, brass, copper, lead and iron. These metals in contact with the HMTD even when dry, will cause corrosion. With water present, in the HMTD, the corrosion would more quickly disable an improvised blasting cap that could be made with this material. Spraying the inside of your copper tubing with urethane plastic would most likely reduce greatly, if not completely stop, this corrosion problem. To manufacture HMTD, use one of the processes below.

Process #1: Obtain 6% hair bleaching peroxide which is available from any beauty salon or beauty supply store. This is a 20 volume hydrogen peroxide. Place 9 teaspoons of this 6% peroxide in a one pint canning jar or 500 ml beaker. In three portions dissolve by stirring 2-1/2 teaspoons of powdered hexamine (Crushed U.S. Army ration heating tablets, See "Kitchen Improvised Plastic Explosives" chapter 2, "Urintropine" etc.). This is stirred until all the hexamine dissolves. The solution should then be chilled in a ice water bath for 1/2 hour. To this chilled solution add, in four portions, 4-1/2 teaspoons of powdered citric acid. Citric acid is readily available and should be found with canning supplies or in a pharmacy. With each addition the solution should be stirred until the citric acid dissolves in the liquid before another addition is made. When all the additions have been made continue stirring the liquid. The beaker or jar containing the solution should remain in the ice bath. The solution will become cloudy. With the completion of the 1/2 hour stirring the liquid is placed in a refrigerator. This will speed the process. If a refrigerator is not available let the solution stand for 24 hours. Filter the solution through a paper towel or coffee filter. The white substance is the explosive.

CAUTION: HMTD is sensitive to shock, impact, friction, heat and open flame. Extreme care should be exercised. HMTD will detonate from any of these stimuli even when soaked with water.

These white crystals are washed with 45 ml of distilled water. Tap water can be used if necessary, but will yield a compound of lesser purity. They are then washed with 75 ml methanol alcohol. These crystals are allowed to dry in a cool dry place. If a 30% technical grade ("Superoxol") of hydrogen peroxide is available it should be used instead of the 6%. If 30% is used the proportions are as follows to use in the same process as above are:

HYDROGEN PEROXIDE. "Superoxol" (30% d. 1.11 G/cc)- 185 G HEXAMINE (Crushed ration heating tablets) 56 G CITRIC ACID (tech. grade or food grade) 84 G.

These are used in the procedure given above. Simply "plug in" the amount immediately above for the spoon wise proportions given in the 6% hydrogen peroxide process and the washing would be done with 150 ml cold water. Of course in the procedure if 35% or 40% is the only type hydrogen peroxide available, then simply calculate the actual weight of hydrogen peroxide. We know that 185 G. of peroxide are used above. This is 30% hydrogen peroxide. $185 \text{ G.} \times .30 = 55.5 \text{ G.}$ We know that we need 55.5 G. hydrogen peroxide. Suppose we have some 40% peroxide. We take our 55.5 and divide by .40 thus $55.5 / 0.40 = 138.75$. Simply use 139.0 G. of this 40% hydrogen peroxide in the procedure above. The yield of this process with 30% hydrogen peroxide is much greater than is the use of 6% hydrogen peroxide. But with the 6% being the easier of the two to obtain it still would hold possibilities.

Process #2: This second process is one of very easy acquisition of the main ingredients. Yield is not as high as the procedure above with either strength peroxide. This process makes use of the easy formation of hexamine and the parallel formation of a slightly acid solution. This acid is liberated from the ammonium sulfate salt. It is, of course, sulfuric acid. This acid performs the function of the citric acid in the procedure above. This is after the free ammonia and the formaldehyde form hexamine. Yield will be relatively low with this procedure but the materials are readily available and cheap. Since this procedure takes place at an elevated temperature there will be some loss of product to this subsequent heat and the decomposition that will accompany it. This process will work and could be used if necessary.

Five hundred grams of 3% hydrogen peroxide are placed in a quart jar or 1000 ml beaker. Three percent hydrogen peroxide is available as an antiseptic solution in grocery stores, etc... To this is added fifty grams ammonium sulfate. Ammonium sulfate is available as common fertilizer. This is stirred until dissolved. This liquid should be heated in a water bath to 55 °C (131 °F). Immediately when the temperature reaches this temperature add 5.3 grams of 37% formaldehyde solution. Stir this solution well and take off water bath. Let this liquid cool to room temperature and set for 24 hours. A white product will be seen in the liquid at this time.

CAUTION: This white product is dangerous and sensitive to FRICTION, SHOCK, HEAT OR FLAME. Handle with great care! Even wet HMTD is dangerous and will detonate with ease.

This is filtered out and washed with one washing of 50 ml distilled water and then with 75 ml of 100% methanol. The methanol will speed the drying process. This white fluffy powder will be HMTD. This powder will be sensitive to friction and small quantities should be handled.

Double Salts

These double salts are a basic acetylide group primary explosive. This explosive has good sensitivity, powder and performance. It is readily made from silver (coin), nitric acid and calcium carbide/ water or acetylene. This is an easy compound to make. What I found interesting is the fact that this primary is not photo active. Most silver salts are light sensitive. This would be a good choice due to the wide availability to the main ingredients. DDNP, HMTD and mercury(II) fulminate, are better primary explosives but this one has many possibilities. With this primary explosive suitable caps could be made and would be very usable and storage stable as some others in this publication could not.

Dilute 10.1 ml of nitric acid (red fuming) with 6.75 ml of water. If reagent or technical grade acid is available (70% strength) this will not need any water mixed with it to reduce the strength. Simply use 17.5 ml of this 70% nitric acid. Place a silver dime or equivalent amount of silver metal in the acid. It will dissolve leaving a green solution.

CAUTION: Avoid the brown gas (nitrogen dioxide) produced when dissolving the silver metal in the acid. This gas is a deadly poison and the immediate exposure to the gas and its subsequent damage will not show up for hours or even days! This should be done with good ventilation!

It may be necessary to heat the liquid to get the coin or metal to completely dissolve. Pour this green solution into a tall slender glass jar such as an olive jar. Place this jar with the green solution in it in a hot water bath and heat. Crystals will form. The heating is continued until these crystals dissolve again. In another flask or even a "Coke" bottle, place ten teaspoons of calcium carbide into this flask with a cork with a hose passing through a hole in the cork. Place the other end of the hose in the tall jar with the solution in it. Remove the stopper from the flask or bottle and add one teaspoon of water.

CAUTION: Acetylene gas is highly flammable and an explosion hazard. Keep away from heat and flame as much as possible.

The gas should begin generating. Add one more teaspoon and place the stopper back into the container. The acetylene gas generated by the calcium carbide and water should be going through the hose and bubbling through the solution in the tall glass. Bubble this gas through the solution for 5-8 minutes. Brown vapor will be given off by the liquid as it absorbs acetylene and white flakes will begin to be formed in the silver solution. Remove the solution from the heat source and allow it to cool. Filter the liquid through a filter paper (paper towel, coffee filter) into a glass container. Green crystals will be caught on the filter paper. These green crystals would then be washed with 45 ml alcohol. The crystals will change from green to white in color and the methanol wash will turn green. Place these white crystals on a paper towel and allow to air dry.

CAUTION: Handle this dry explosive with great care. Do not scrape or handle roughly. Keep away from flame or spark source or heat and store in a cool dry place.

Lead Azide

Preparation of Hydrazinium sulfate. One-hundred-forty-one ml of Clorox bleach (5.25 percent NaOCl) was added to 200 ml of 20 percent ammonium hydroxide and 5 ml of 1 percent limewater $\text{Ca}(\text{OH})_2$ in one liter Erlenmeyer flask. The mixture was rapidly heated to boiling and maintained until the volume was reduced to about half, which required about one-half hour. The solution was rapidly cooled and dilute sulfuric acid was added until a pH of 7-8 has attained and the precipitate that formed was separated by filtration. The cold filtrate was strongly acidified with 40 percent sulfuric acid. The white precipitate was filtered, washed with methanol and air dried. Melting point 254 degrees °C.

Preparation of Isopropyl Nitrite. A mixture of 45 ml concentrated sulfuric acid, 30 ml water and 110 ml isopropyl alcohol, previously cooled to 0 °C, was added to an ice cold solution of 114 grams of sodium nitrite in 450 ml of H₂O. Slow addition required about two hours in order to maintain a temperature around 0 °C. The upper oily layer was separated and washed three times with 30 ml portions of 5 gram 100 ml sodium bicarbonate solution and 22 grams NaCl 100 ml solution respectively.

Preparation of Sodium Azide. Five grams of caustic soda (NaOH) was dissolved in 50 ml of ethyl alcohol (3A), and the clear portion was decanted in a 100 ml distilling flask containing 6 ml of hydrazine hydrate. After adding one ml of butyl nitrite (or isopropyl nitrite) the mixture was heated on a steam bath to initiate the reaction. Twelve ml more of the nitrite was slowly added in such a manner that the mixture refluxed slowly. Addition required about one hour and the mixture was heated an additional fifteen minutes. The reaction

flask was cooled and the solid product collected on a filter. The product was washed with alcohol and air dried. Recrystallization from water yielded white crystalline material.

Preparation of Lead Azide primary explosive. The following solutions were prepared:

- Solution A: 0.20 g of sodium azide 0.006 g of sodium hydroxide 7 ml water.
- Solution B: 0.96 g $\text{Pb}(\text{NO}_3)_2$ 0.04 g Dextrin 9 ml water.

Solution B was brought to a pH of 5 by adding dilute NaOH. Solution B was brought to 60 °C and solution A was slowly added with stirring. The mixture was allowed to stir till ambient temperature was attained and the solid azide collected on a filter. After washing with water and air drying the product weighed 0.4 grams. This product was found capable of initiating RDX when incorporated in a No. 6 blasting cap.

Chlorate Mixture

ALL CHLORATE BASED EXPLOSIVES ARE SENSITIVE TO FRICTION, AND SHOCK, AND SHOULD BE AVOIDED IF POSSIBLE.

This explosive is a chlorate primary explosive from bleach. This method of production of potassium or sodium chlorate is easier and yields a more pure product than does the plastique explosive from bleach process. In this reaction the calcium hypochlorite (CaClO) is mixed with water and heated with either sodium chloride (table salt, rock salt) or potassium chloride (salt substitute). The latter of these salts is the salt of choice due to the easy crystalization of the potassium chlorate.

This mixture will need to be boiled to ensure complete reaction of the ingredients. Obtain some calcium hypochlorite swimming pool chlorination compound or equivalent (usually 65% calcium hypochlorite). As with the bleach, it is also a dissociation reaction. In a large pyrex glass or enameled steel container place 1200 g calcium hypochlorite and 220 g potassium chloride or 159 g sodium chloride.

Add enough boiling water to dissolve the powder and boil this solution. A chalky substance (calcium chloride) will be formed. When the formation of this chalky substance is no longer formed, the solution is filtered while boiling hot. If potassium chloride was used, potassium chlorate will be formed. This potassium chlorate will drop out or crystalize as the clear liquid left after filtering cools. These crystals are filtered out when the solution reaches room temperature.

If the sodium chloride salt was used this clear filtrate (clear liquid after filtration) will need to have all water evaporated. This will leave crystals which should be saved. These crystals should be heated in a slightly warm oven in a pyrex dish to drive off all traces of water (40-75 °C). These crystals are ground to a very fine powder (400 mesh).

The potassium chloride is the salt to use as the resulting product will crystallize out of solution as it cools. If the sodium chloride salt is used in the initial step, the crystallization is much more time consuming and it will have a tendency to cake and has a slightly lower detonation velocity. The powdered and completely dry chlorate crystals are kneaded together with vaseline in plastic bowl.

This explosive is composed of the following:

- Potassium or sodium chlorate 90%.
- Vaseline 10%.

The detonation velocity can be raised to a slight extent by the addition of 2-3% aluminum powder substituted for 2-3% of the vaseline. The addition of this aluminum will give this explosive a bright flash if set off at night which will ruin night vision for a short while. The detonation velocity of this explosive is approximately 3200 m/sec for the potassium salt and 2900 m/sec for the sodium salt based explosive.

Black Powder

Black powder is a weak flammable explosive. It is very useful in because it is stable, non-corrosive and cheap to make. This makes it very good for homemade ammunition.

Materials:

- Charcoal. Willow, birch, fir, oak, beech, ash, pine and spruce are good.
- Isopropyl or denatured alcohol.
- Potassium nitrate.
- Sulfur.

1. Chill 2 1/2 cups (or 600 ml) of isopropyl or denatured alcohol for every 100 grams of charcoal/sulfur mix you have.
2. Measure your ingredients. The components of black powder used to be measured by weight. This has been calculated out, nowadays, as 75 parts potassium nitrate, 15 parts charcoal and 10 parts sulfur (or 25% charcoal/sulfur mix).
3. Prepare your nitrate. Measure 1/4 cup (or 40 ml) of water for every 100 grams (about a 1/2 cup) of potassium nitrate in an old pan. Add your potassium nitrate. Bring to a boil. Stir continuously. Add little bits of water at intervals until the potassium nitrate is completely dissolved.
4. Add the charcoal/sulfur mix to your pot of boiling potassium nitrate. Stir until all ingredients are completely combined.
5. Take your chilled alcohol and your hot mixture outside. Add the hot mixture to your isopropyl alcohol. Stir together.
6. Chill this new mixture. The more quickly you can chill this to 0 °C (32 °F), the better.
7. Filter the mixture through cheesecloth or an old cloth. This will remove all the liquid from the solution. Throw out the liquid that got filtered out.
8. Lay the mix out on a piece of paper to dry in the sun.
9. Press the mixture through a sieve while it is still slightly damp. Spread it out on your paper again and allow it to dry some more.
10. Run the powder through the sieve or a series of mesh screens a few more times to get it completely broken up.
11. Store your black powder in a cool, dry place in plastic containers. Make sure to choose a place that is out of the reach of children.

Fireworks

Fireworks and firecrackers are explosive (either primary or secondary), but very weak and very sensitive. However, some firework and firecracker powder is not flammable, but is still

sensitive to friction and shock. Shrapnel will be the dangerous thing when using firework or firecracker powder as they were simply designed to be loud, not dangerous. Do not use firework powder as a propellant in ammunition. Doing so will produce loads of sparks of color and smoke. Firecracker powder is more acceptable, but will still produce lots of smoke.

Picric Acid

Form: colorless to yellow solid/crystal needles.

Melting point: 122,5 C.

Boiling point: >300 C (Explodes).

Solubility in water: 14.0 g/L.

Insoluble in cold water.

Sensibility: Impact: moderate, Friction moderate-low: water sens: moderate.

VOD: 7350 m/s.

Must be stored wet with at least 10-20% water.

Picric acid (Trinitrophenol) used to be the most common high explosive before TNT was commercialized and was used as the primary explosive for munitions during the First and Second World War. Picric acid is considered in the same category as TNT, the only drawback of Picric acid is that it reacts with metals. Picric Acid can be mixed with olive oil as a means of reducing sensitiveness. These explosives are relatively insensitive and are used to strengthen the explosion of the detonator. These explosives are classified as a high explosive.

When washing, use only cold water (because it is soluble in hot water). The next morning the picric acid will be found to have separated in crystals. These are transferred to a porcelain filter, washed with small portions of water until the washings are free from sulfate, and dried in the air. The crude product, which is equal in quality to a good commercial sample, is purified by boiling it with water, in the proportion of 15 grams to the liter, filtering hot, and allowing to cool slowly. The heavy droplets of brown oil which dissolve only slowly during this boiling ought to be discarded. Pure picric acid crystallizes from water in pale yellow flat needles

The only problem I had while making it was that when you dump the finished nitrated liquid into ice water to precipitate the picric acid, a lot of the picric dissolves in the water. Is there any way to get the dissolved picric out of the water? Ensure you have enough ice and add just a little at a time. Keep it cool or it will fail to precipitate properly.

CAUTION! THIS COMPOUND MAY EXPLODE INSTANTLY WHEN TOUCHED WITH METAL!

Also, don't inhale any of the fumes given off during the nitrate addition to the acid mix. Do all the heating and mixing outdoors or counter by having good ventilation in addition to wearing a gas mask (3M with acidic/vapor/organic filter).

It is best handled in a wet 10 percent distilled water form, as picric becomes very unstable when completely dry. This compound should never be put into direct contact with metal, since instantly on contact there is a formation of metal picric, which explodes

spontaneously upon formation. Any metal in contact with picric acid should be coated with an acid proof paint or an epoxy coat, or just not used at all.

Modern safety precautions recommend storing picric acid wet. Dry picric acid is relatively sensitive to shock and friction, so laboratories that use it store it in bottles under a layer of water, rendering it safe. Glass or plastic bottles are required, as picric acid can easily form metal picrate salts that are even more sensitive and hazardous than the acid itself.

Safety glasses, adequate ventilation. If working with anything other than a solution or the wet solid full face protection is essential.

Maintain at least a 20% water content at all times. Never try to open a bottle of picric acid if crystals are visible at the rim of the bottle, even if the bottle contains water, since the friction when the cap is twisted may be sufficient to detonate the acid. When the substance goes beyond a certain time-frame, it can become dangerous to transport so produce not longer than 2-4 weeks before use.

Maintain at least a 20% water content at all times. Never try to open a bottle of picric acid if crystals are visible at the rim of the bottle, even if the bottle contains water, since the friction when the cap is twisted may be sufficient to detonate the acid. When the substance goes beyond a certain time-frame, it can become dangerous to transport so produce not longer than 2-4 weeks before use.

Shells which are to be loaded with these explosives are first plated on the inside with tin or painted with asphaltum varnish or Bakelite.

Shells which are to be loaded with these explosives are first plated on the inside with tin or painted with asphaltum varnish or Bakelite.

Aspirin must be acquired to manufacture picric acid. It can be bought with cash in drug stores, at about 6 euros per package – that is a total of 1140 Euro for 190 packages. The best cover story is to buy the aspirin for your “company” in time for a holiday where people drink lots of alcohol (such as Christmas). This was the easiest task ever. The main problem was that there are only 30-40 drug stores in my city and only 20 of them are within walking range of each other. I first attempted to purchase up to 10 packages per drugstore but with little success, due to the fact that it is not legal to sell more than 2 packages per customer. Larger purchases require a written notice from a medical professional. I ended up creating a “walking route” which included the purchase of 3 packages per drug store. Route covered 20 drug stores and took around 4 hours of constant walking to complete. Doing this by car would have taken even longer due to parking limitations in my city, and bicycle was out of the question as it was too much snow. I ended up using 4 full days (1 x route x 4 times) before I had enough aspirin. I waited 7-14 days before starting the purchase route again as I wanted to avoid being recognized by the pharmacy clerks. A few of them did recognize me though but since I appeared to be a professional (designer business regalia) and an upstanding citizen, I believe no red flags were raised. High class regalia used for purchase round to avoid raising flags. I started out buying the expensive Bayer Aspirin but quickly reverted to the purchase of a generic brand instead, as it was much cheaper.

3 guides for synthesizing picric acid will be written about.

Guide 1: Trinitrophenol is also called Picric Acid, TNP, Lyddite and Shimose. This explosive is slightly more powerful than TNT, and has a VoD of 7480 m/s at 1.76 g/cm². Relative briscancy = 1.21. It can be used as-is, or to make the following explosives: Ammonium Picrate (Explosive D), DDNP and Lead Picrate.

It is relatively storage stable, but will form dangerously sensitive metal Picrates if it comes into contact with certain metals. To store it in absolute safety, make a saturated solution out of it in alcohol and store it in sealed glass containers. It can be stored indefinitely like this.

You will need:

- 96 aspirin tablets, each containing 300mg of aspirin.
- 120mL of 95% sulfuric acid.
- 60g of potassium nitrate.
- Acetone.
- Distilled water.
- Some ice cubes (c. 10).
- A pestle and mortar.
- A gas or alcohol burner.
- A 250mL conical flask.
- A 1L container.
- Two 250mL beakers.
- A 500ml beaker.
- A filter funnel.
- A thermometer.
- Filter papers.
- A glass rod.

1) Place the aspirins in the pestle and mortar, and crush them. They don't have to be fine, but the finer they are the better.

2) Heat 150mL of acetone (methylated spirits will work) in a 250mL beaker until it's nearly boiling. Add the aspirin powder, and stir it with a glass rod until the grains have all disintegrated, leaving a small amount of white powder at the bottom of the alcohol.

3) Filter this liquid into the other 250mL beaker. Throw away the solid left on the filter paper.

4) Gently heat the filtrate to reduce its volume, until crystals begin to appear. Then let it cool and evaporate over night in a warm place.

5) Scrape up the crystals, and store them.

6) Heat the sulfuric acid to 65 °C in a 250ml flask, and while it's heating up gradually stir in the purified aspirin using the thermometer.

7) When all of the aspirin has been added, let the solution cool to 50 °C.

8) Add the potassium nitrate constantly, at a rate of about 1 to 2 grams every minute, while stirring rapidly. The temperature should be kept between about 60 °C and 70 °C. When I do this, I get very little nitrogen dioxide formed, just nitric acid vapors and CO₂, formed by decarboxylation. Others claim to have clouds of nitrogen dioxide formed. This is because they add the potassium nitrate too fast, and it wastes the potassium nitrate.

9) When all of the potassium nitrate has been added, let the solution cool to room temperature, and dump it into 300mL of distilled water, with the ice cubes, in a 1L container. This will precipitate out the Trinitrophenol as light canary yellow crystals.

- 10) Filter the liquid once most of the ice has melted, or remove the ice when the temperature is below 5 °C, and discard of the liquid carefully as it is toxic and corrosive. You can concentrate it and extract slightly more Trinitrophenol, but it isn't really worth it..
- 11) Take the crystals formed, and add them to 100mL of boiling water in a 500mL beaker. Stir, and add more water until all the crystals have dissolved.
- 12) Cool the solution in the fridge, and filter out the purified crystals.
- 13) Leave them spread out to dry.

Guide 2: From “Preparatory Manual of Explosives – Ledgard.pdf”. Picric acid is a pale yellow, odorless solid with a melting point of 123 °C. It explodes when heated to 300 °C. It is relatively insoluble in water, but soluble in alcohol and benzene. Picric acid is toxic and can be absorbed through the skin with effects similar to DNP. Picric acid should be stored wet with 10% water, and kept in a cool place and away from fire. Picric acid will detonate if rapidly heated or on percussion – the percussion is much higher than for most primary explosives.

VOD: 7400.

Sensitivity: Low.

Stability: Good.

Flammability: Burns with smoky flame but may flash on strong ignition.

Toxicity: Above moderate.

Classification: Secondary explosive.

Overall value (as secondary explosive): High.

Materials:

- 50 g of aspirin
- 350 ml of 95% ethyl alcohol
- 350 g of 98% sulfuric acid
- 115 g of potassium nitrate or 95 g of sodium nitrate

Summary: In this procedure, picric acid is prepared by the reaction of common aspirin with potassium or sodium nitrate in the presence of excess concentrated sulfuric acid. After the reaction, the entire mixture is then drowned into an excessive amount of ice water, whereby the picric acid precipitates, and is then collected by filtration, washed and then dried.

Hazards: Use caution when handling 98% sulfuric acid, which is highly corrosive and chars many substances. Extinguish all flames before using 95% ethyl alcohol, which is flammable.

Procedure: Place 50 g of aspirin into a beaker, and then add 350 ml of 95% ethyl alcohol (note: about 50 g of aspirin can be obtained by crushing up 100, 500 mg tablets of store bought aspirin tablets – these crushed up tablets can be added directly to the 350 ml of 95% ethyl alcohol). Thereafter, stir the mixture to fully dissolve the aspirin, and then filter off any insoluble impurities – such as starch, and other fillers (if using medical aspirin tablets), and then recrystallize the aspirin from the 95% ethyl alcohol solution. Thereafter, vacuum dry or air-dry the collected aspirin crystals. Now, into a clean flask equipped with thermometer, motorized stirrer and powder funnel, place 350 g of 98% sulfuric acid, and then place this flask into an ice bath, and chill to 0 °C. Thereafter, slowly add in small portions, 115 g of potassium nitrate or 95 g of sodium nitrate to the sulfuric acid over a

period of about 1 hour, while rapidly stirring the sulfuric acid, and maintaining its temperature below 5 °C. After the addition of the sodium or potassium nitrate, slowly add the dry recrystallized aspirin, in small portions, over a period of about 1 hour while rapidly stirring the sulfuric acid/nitrate mixture, and keeping it temperate below 5 °C. After the addition of the aspirin, replace the powder funnel with a condenser, and reflux the mixture for 2 hours at 60 °C while rapid stirring. After 2 hours, remove the heat source and allow the reaction mixture to cool to room temperature. Then gradually add the reaction mixture to 1500 ml of ice water, and then allow the entire mixture to stand for 3 hours. Thereafter, filter off the precipitated picric acid, wash excessively with 10, 250 ml portions of ice cold water. Note: washing with base to remove traces of acid should be avoided as formation of the corresponding picrate salts may develop. After the washing process, vacuum dry or air dry the solid product.

Note, equipment used: a condenser and a hot plate stirrer is a bonus but not required.

Guide 3:

1. Crush 20, 5 grain aspirin tablets and add 1 tsp. of water to it to make a paste.
2. Stir in 1/2 cup of ethyl alcohol to the aspirin paste and then filter the solution to remove any solid particles.
3. Evaporate the alcohol and recover the crystals that are left.
4. Pour 1/3 cup of concentrated sulfuric acid into a large jar and add the crystals from the alcohol solution.
5. Heat the acid in a simmering hot water bath for 15 minutes The acid should turn a reddish color.
6. Now add 15 grams of potassium nitrate to the acid 5 grams at a time while stirring.
7. Let the acid cool to room temperature then pour the acid slowly into 1 1/2 cups of water and let it cool down again.
8. Filter off the particles of picric acid and wash them with 1 cup of ice water. Dry these crystals before using them.

Picric acid is a very strong dye. Contact with it will stain just about anything. Picric acid also reacts with metal to form picrate salts that are a hazard.

Nitrocellulose

Nitrocellulose (NC), also known as guncotton, is a weak and flammable secondary explosive fit for use as a propellant. That is where it got its name, 'guncotton'. It is otherwise too weak to be used as an explosive unless used in pipe bombs. The major disadvantage is that it is corrosive. The ammunition will have to have its case's insides covered in something such as nickel to protect it from corrosion.

WARNING : This preparation deals with concentrated sulfuric and nitric acids and Nox gases. Both acids are extremely corrosive and can burn and blind a person. In addition, gloves made of nitrile or most other plastics do not provide adequate protection and should not be used, especially given that nitric acid can instaneously ignite such materials . Oxides of nitrogen produced by this experiment are extremely toxic (more so than chlorine).

NC can be prepared by nitrating a source of cellulose with nitric acid and concentrated sulfuric acid. The main source of cellulose used is cotton, as it is almost entirely made of

cellulose. For the acids, it is possible to use a mixture of concentrated nitric and sulfuric acids, or to directly dissolve a nitrate salt in excess concentrated sulfuric acid, forming the nitric acid directly, thus saving the need to distill the HNO₃. Many procedures using different proportions exist to prepare nitrocellulose. Here are some of them: This preparation have been tested and works very well, burning in a flash leaving almost no ash behind.

1. Prepare 2,5 g of cotton, 0,25 mol* of a nitrate salt (for example, 25 g of KNO₃) and 50 mL of concentrated sulfuric acid.
2. In a beaker, dissolve the 0,25 mol of a nitrate salt in 40 mL of the sulfuric acid. You may need to stir a lot and wait up to 30 min for the salt to completely dissolve.
3. Add the cotton and soak it in the solution using a glass rod.
4. Remove the beaker from the ice bath and let it sit for 25 minutes.
5. Add the remaining 10 mL of concentrated sulfuric acid and mix to make sure all the cotton is completely soaked once again. Be careful, it might be so hard to mix that it'll break your glass rod.
6. Let it sit for 1 hour.
7. Rinse the cotton with an huge amount of water to dilute and flush out the acids.
8. Add the cotton to a solution of NaHCO₃ (sodium bicarbonate) to neutralize what is left of the acids. Once the bubbling stops, let it soak an additional 30 min to make sure the acids are completely neutralized.
9. Rinse with a lot of water to flush the NaHCO₃.
10. Let the nitrocellulose dry completely before use.

*A mol is defined as exactly $6.02214076 \times 10^{23}$ elementary entities which may be atoms, molecules, ions, or electrons.

Additional notes and tips:

- Use very pure and smooth cotton, if the cotton is a cheap brand and has just a few small knots in it, it will still work but it will burn more slowly and leave more ash behind.
- Even with a good brand of cotton, a negligible amount of ash is left behind. You won't see them if you burn it in your hands or in the air, but you will if you burn it on something white.
- An ice bath is often used in nitrations to prevent runaway reactions. However, using this approach with KNO₃, I found that the temperature does not change much. In fact, the ice bath just freezes the mix and it is a real pain to work with a frozen nitration mixture with cellulose in it. That is why I do not recommend an ice bath.

Urea Nitrate

Sources for Urea (a secondary explosive) is the fertilizer: 46-00-00 or often the prills used for de-icing sidewalks. Urea can also be derived from concentrated urine (animal and human). This is a common variation used in South America and the Middle East by terrorists. Many animals (e.g., dogs) have a much more concentrated urine and it contains a higher urea amount than normal human urine.

Urea nitrate would not be the method of choice for +100 kg detonations due to the rapid decomposition of the more unstable urea nitrate which reduces the shelf life to 30 days. AN is preferred as it is much more stable and has a considerably longer shelf life (up to 1-

2 years). Also, it takes considerably longer and more knowledge in chemistry to convert urea fertilizer to urea nitrate, compared to AN. The only advantages of Urea nitrate is that it is easier to acquire the products needed and it is more sensitive to detonation than AN.

Urea nitrate can be prepared by reacting urea with nitric acid. The reaction is exothermic (produces heat), so it's best to do it at low temperatures. Urea nitrate can be prepared via a double replacement by combining urea with a nitrate salt and concentrated hydrochloric acid in water. Gentle heat, as from a water bath, should be added to bring the urea and nitrate into solution before the HCl is added. The turbid solution clears as the HCl is added and a copious precipitate of urea nitrate is obtained when the solution is cooled below 0 °C. The remaining solution contains a small amount of product and the chloride salt of the cation whose nitrate was used.

Ammonal/Tannerite

Ammonal (also known as Tannerite) is a secondary explosive often used for shooting sports and practice in the USA, as it is relatively safe to handle and detonates when shot. It is a good secondary explosive if the ammonium nitrate used is purified, as if it is not, it will be harder to detonate.

- 95% (by weight) ammonium nitrate.
- 5% (by weight) aluminum powder (300-600 cross section).

The ammonium nitrate should have the consistency of salt granules, which can be achieved with a blender, espresso processor (read about grinding methods in the ammonium nitrate section), or even a mortar and pestle in a decently ventilated territory with no open flames. Its ignition point is 449° °C.

Put both parts into a compartment with a lot of additional space so you can blend them completely. I get a kick out of the chance to put them into an one gallon container, filling it half way and shaking it vivaciously for about five minutes. The effect of a round shot from any rifle bigger than a .22 LR will give sufficient power to launch explosion or by using a detonator.

ANFO

ANFO is a tertiary explosive that requires 93% ammonium nitrate (AN) and 7% fuel oil (FO) by weight (official recommendation by Dupont). However, In practice, a slight excess of fuel oil is added to compensate for any evaporation. ANFO generally requires a booster in order to detonate. The booster will basically increase the effect of the blasting cap to ensure reliable detonation. It is better to create a larger booster than necessary to avoid taking unnecessary risks. The purer AN you have the smaller booster you will need and vice versa. Diesel can be used as the FO, but no. 2 fuel oil (also called home heating oil) is preferable.

A more common and very effective method of mixing AN and FO is by uniformly soaking prills in opened bags with 8 to 10 percent of their weight of oil. After draining for at least a half hour the prills will have retained about the correct amount of fuel oil.

The fuel will disperse relatively rapidly and uniformly. Inadequate priming imparts low initial detonation velocity to a blasting agent, and the reaction may die out and cause a misfire. So ensure a large enough booster/blasting cap.

Place the AN into the waterproof container. Sprinkle the diesel fuel onto the AN. Do not "stir" these materials, as that will cause them to pack together. Let stand for 1 hour. Seal the waterproof container.

Note: if powdered AN is being used and it becomes packed, it may be fluffed by ruffing a handful back and forth across a piece of screen or a cheese grater. If AN prills are used (compared to powdered AN) a larger booster charge must be used. Finally, ANFO charges must be at least 5 cm in diameter or they will not detonate properly.

Size of prills matters. However, there is usually little you can do about this fact, with the exception of choosing to powder the AN. In the mining industry, the term ANFO specifically describes a mixture of solid ammonium nitrate prills and No. 2 fuel oil (heating oil.) In this form, it has a bulk density of approximately 840 kg/m³. The density of individual prills is about 1300 kg/m³, while the density of pure crystalline ammonium nitrate is 1700 kg/m³. It is notable that AN prills used for explosive applications are physically different from fertilizer prills; the former contain approximately 20% air. These versions of ANFO which use prills are generally called explosives grade, low density, or industrial grade ammonium nitrate. These voids are necessary to sensitize ANFO: they create so-called "hot spots".

ANNM

ANNM usually contains a 60:40(kinepak) mix of AN and NM (60% ammonium nitrate, 40% nitromethane by mass), though this results in a wet slurry. However, a smaller portion of NM may be used. Sometimes more AN is added to reduce liquidity and make it easier to store and handle, as well as providing an oxygen-balanced mix. ANNM is also more sensitive to shock than standard ANFO and is therefore easier to detonate. These factors, plus its higher RE and VOD, make it a popular explosive among recreational users. ANNM detonates at 22,700 fps.

The quality of your end product really depends on the AN, how fine it is and the quality. Industrial ANNM (used for blasting) is 10% NM with medium prills of AN. Higher strength versions include aluminium dust but it should be a microfine dust to get best results. Now on how to acquire nitromethane.

Nitromethane

Pure nitromethane is an insensitive explosive with a VoD of approximately 6200 m/s. The reason why NM is so much more powerful than diesel is that nitromethane generates about 2.3 times the power of gasoline when combined with a given amount of oxygen. NM can be obtained from hobby air-plane fuel. The fuel, depending on brand and type, contains anywhere from 12-35% NM. Hobby plane boat-fuel contains the highest percentage (approx 30-50%) while plane/helicopter fuel is on a second with 12-35%. Model car fuel normally contains the least amount of NM. Ensure that you have created a cover story (that you say you own a T-Rex 600 for example) before you make a purchase.

The average price for a 4 L can of fuel (containing 30% NM) is approximately 31 Euro. In other words; if you want 10 L of pure NM you would have to buy 8-9 of these cans for a total of 280 Euro providing you are able to extract 100% of the NM (which you probably won't). This fuel usually consists of: 30% NM, 12% oil lubricant and 58% ethanol. I ordered almost 4 cans of this fuel from each available supplier (total of 5 suppliers) and ended up with 18 cans. I could go to my neighboring countries to buy more or I would have to wait 6 months time before I make another purchase (to prevent suspicion from the suppliers). The fuel can only be transported by ground.

NM is not as dangerous as people would have you think. In fact, nitromethane is one of the safest and cheapest liquid explosives available on the market. It cannot detonate from flame and it is in fact very hard to ignite with a match, and if it does burn, it does so with a lazy blue flame. However, NM is shock sensitive from 6 meters. Nevertheless, as long as you don't expose pure NM to shock or severe friction you will be OK. It is very stable.

- You can set it on fire, it simply burns like ethanol. Since it is flammable liquid, its vapor with air may form an explosive mixture (like many organic solvents).
- Nitromethane is in fact very hard to ignite with a match, and if it does burn, it does so with a lazy blue flame. It does detonate on shock though. It is very stable.
- I'm under the impression that nitromethane is definitely an explosive. It is just much less shock sensitive than theoretic claims.
- Do not pour it into a glass container as the edges have too much friction causing an explosion. Never heat it. Never drop on floor, avoid shock.
- Never touch it as it reacts with skin and the person affected will be killed within 36 hours.

Dilution of the NM mixture with methanol doesn't prevent the invention from working. The dilution just makes the mixture more difficult to detonate, and the explosive force released is correspondingly reduced. To detonate a methanol solution of NM, about one ounce of high explosive booster is needed. Really diluted solutions, such as one would get from 10% NM product would need even more booster. The mixture keeps really well as long as it is sealed up to prevent the NM and amine from evaporating away. One ounce (28,35 g) is required to detonate.

Mixing 84 parts by weight AN with 16 parts by weight of 50% solution of NM in methanol explosive is as powerful as high grade dynamite. Weaker concentrations of NM could be used instead of 50% but performance would suffer. I wouldn't bother with any product under 30% NM. In a known explosives patent, they specify using fertilizer prills of AN. However, finely ground AN made according to the directions in this section would also work. To enhance the performance of this mixture, one could mix in up to 10-15% by weight of AL powder. According to the patent, this mixture can be detonated with a number 8 cap, and doesn't need confinement for complete detonation.

Purification of NM-hobby fuel. NM can be purified by cooling below its freezing point (28 C), washing the solid with cold diethyl ether, followed by distillation. How to get more out of Nitromethane? Mix with Trichloroethane (common cleaning fluid)(40 parts AN, 9 parts NM, 3 parts Trich).

Now the procedure to separate NM from methanol in hobby fuel will be written.

Evaporation: It will be hard to get pure nitromethane from your fuel but you should end up with a suitable mix consisting of 50-80% NM, 12% oil and the rest methanol. Methanol evaporates considerably faster than nitromethane, so I'd first just expose it to the air and see when the volume of the liquid had dropped about the right amount. At that point, I don't know exactly how well the oil, nitromethane, and remaining methanol will separate. Do not let it evaporate below 50% of the original volume or you will end up with more oil than nitromethane.

Freezing: Example racing fuel contains:

- 30% NM (CH₃-NO₂).
- 12% Oil (X-YZ).
- 58% Methanol (CH₃-OH).

We first need to know the properties of the components to be able to separate them:

1. All are soluble in each other.
2. Their boiling points:
 - NM boiling point = 101°C; freezing point = -29 °C.
 - Methanol boiling point = 65°C; freezing point = -98 °C.
 - Oil boiling point >200°C; freezing point = -10 to -30 °C?

With this information we can conclude that simple freeze distillation can be the way to go. Methanol will be separated and you will be left with NM and oil mix. Freezing is, theoretically, a good way to get the methanol out. I haven't tested it out personally but it should work. Most commercial freezers go as low as -25 to -30 °C which is enough to freeze the NM and thus making it easy to separate the methanol. This process should be repeated so that you ensure that you get most of the NM.

According to one forum source; it doesn't matter if the oil is left in the mix as it won't be able to make the compound inert. So the final mix should still be effective when creating ANNM.

Fractional distillation: Nitromethane distillation from racing fuel is fairly straightforward. It works as a classic simple distillation but to get good results you should try to fraction it as much as possible (long column, packing...). You have to use a decent distillation setup with a thermometer. And no open flames! Electric heating!

1. The temperature remains stable at the boiling point of methanol (65 °C). You have only methanol coming. This is by far the largest fraction. You might as well stop here or you can continue if you want to gain even purer results.
2. Temperature starts rising. You are now collecting a mix of methanol and Nitromethane. This is a large fraction, don't discard it, re-distill.
3. Temperature stays at the boiling point of nitromethane (101 °C). You are now collecting nitromethane.
4. You stop getting condensates and your oil begins to smoke a bit. Turn the heat off. If you didn't fraction your distillation enough, a second distillation will give you almost pure nitromethane.

I got 150ml of rather pure nitromethane out of a gallon of 10% nitro fuel. And for goodness sake DON'T USE A PROPANE BURNER! I did once, and underestimated the temperature. The glass vessel melted. Luckily it didn't contain anything combustible / explosive. The

Merck index says nitromethane forms explosive salts. Therefore, I believe the extraction of nitromethane with an alkali is not a good idea. These salts are known as nitronates and are extremely unstable. This problem may occur if you boil the NM mix at 80 °C or above. Small yellow spots may form which is the forming of nitronates. As you turn the heat off, the yellow solids will re-dissolve in the initial nitromethane fraction.

Note: there is no good reason why you need purer than 80% NM, so don't go overboard on the fractional distillation. The risks and efforts are not worth it.

How To Make ANFO/ANNM More Potent

- Aluminum powder. Adding 5 to 20 percent (15% is optimal), by weight, microfine aluminium powder (30 mesh (JIS sieve) or below is optimal) will increase the VOD substantially. The reason why this is often ignored is due to the high cost of aluminium dust. AL makes the mixture more sensitive to detonation and increases the power output of the product. Thus a smaller primer is needed.
- 3 hydrogen containers (tanks of bottled hydrogen). Three tanks of bottled hydrogen are placed in a circular configuration around the main charge, to enhance the fireball and afterburn of the solid metal particles. Placing 3 hydrogen containers (on all three sides of the main charge) will increase the blast considerably and add a very potent and lethal incendiary effect. Compressed hydrogen is used for mobile hydrogen storage in hydrogen vehicles. It is used as a fuel gas. At this point in time, 2010, there are at least a few hydrogen filling stations in most European capitals. Two cars that use this fuel: Toyota Prius, Mazda RX-8. You would need three hydrogen storage containers, for example the "Palcan Hydrogen System" container. The use of compressed gas cylinders in this type of attack closely resembles the 1983 Beirut barracks bombing. Both of these attacks used compressed gas cylinders to create fuel-air and thermobaric effects that release more energy than conventional high explosives. Thermobaric effects is also a requirement if you plan to detonate a propane-truck (two stage detonation is required for optimal effect, but a thermobaric effect (detonatingfuel-air) is likely to be able to compensate for the lack of the two-stage detonation process. A 50 100 kg booster should be enough in this regard.
- Larger detonator and or booster is always a positive factor. Using a larger blasting cap/booster will increase the VOD of ANNM or more precisely, if you fail to use a large enough blasting cap/booster you will fail to detonate all the ANNM optimally.

Propane

Propane is not technically an explosive but is very flammable and powerful. It is absolutely simple. And we will make it simpler for you! This recipe gives you the ability to make a propane bomb even in countries with tight security and surveillance. The reason is: primary materials easily available and they do not raise suspicion. These materials are not explosives in nature. But after you have assemble and prepare them, they become a bomb ready for destruction.

This type of bomb is not powerful enough to destroy buildings, but is very effective in killing individuals. Very effective against crowds.

The merit of this method is that you can prepare a propane bomb in a few hours during the availability of the primary materials. So there is less worry about your personal security.

- Propane tank. Hydrogen, methane, and acetylene tanks are also good.
- Air tank. SCUBA tanks work well.
- Barometer.
- Connecting nut and pipe.
- Decoration lamps.
- Match-heads.
- Epoxy.
- Tissue.
- Battery (12v or more).
- Wire.

We are going to mix two gases; one an oxidizer, another a fuel, in one sealed container that will change the normal combustion of the two materials into an explosive combustion. The explosion will start as soon as a flame emitted from a torch comes in contact with the gas that will burn rapidly under very high pressure.

Pressure units:

- The standard atmosphere that we live in is a unit of pressure.
- The standard atmosphere is almost equal to one bar (1 bar \approx 1 atm).
- In this procedure we are going to use 'bar' as the standard pressure unit for the gas cylinders.
- When you come across any other unit in your barometer e.g. Pascals, kiloPascals or psi, convert it into bar.
- Conversion is very simple, all you have to do is use a converter in your computer OS calculator.
- A Cooking Gas Cylinder can sustain up to 12 bars.
- An Air Cylinder can sustain up to 135 bars. 'kg/cm²' is the same as atm (atmosphere).

Pressure difference: while the tap is closed, the pressure in the yellow balloon is zero, while the pressure in the red balloon is one. But when we open the tap, gas moves from the high pressure region (red balloon) to the low pressure region (yellow balloon) in such the pressures in the two balloons become equal.



Closed tap.



Opened tap.

Pressure measuring instruments are called 'barometers'. There are different types of barometers, some measure up to 11 bars, others up to 280 bars, and others in between. Barometers used to measure tire pressure usually measure up to 11, 12 or 16 bars. Barometers used for gas cylinders differ as per the type of the cylinder. For example, large Air cylinders use barometers of 240 bars or 280 bars. Medium cooking gas cylinders use barometers of 34 or 36 bars. There are also many other types of barometers. Barometers use different units, some use bars, others 'atm', pound per square inch (psi), Pascals (Pa) or millimeter of mercury (mmHg).



This barometer is sometimes called a 'regulator'. We will use it in these instructions. The meter on the right measures the pressure in the air cylinder – its maximum measurement is 28,000 kiloPascals (kPa), equivalent to 280 bars. While the meter on the left measures the cooking gas cylinder - its maximum measurement is 1400 kPa, equivalent to 14 bars.



This tire barometer can measure up to 11 bars. We will use it in our procedure.



The meter on the right measures a maximum of 25 atmospheres - almost equivalent to 25 bars, while the meter on the left measures a maximum of 2.5 atmospheres – almost equivalent to 2.5 bars.



This tire barometer can measure a maximum of 16 bars.

Mixing the gases:

1. Discharge gas from the Cooking Gas Cylinder until only 9 bars are left in it.

Note: to be sure of the required amount, you have to measure the pressure after every few moment of releasing the gas. Use a barometer suitable for the cooking gas cylinder.

Note: If you do not have the suitable barometer, there is a simple way to measure the pressure by a tire barometer.

2. Take a normal cooking gas regulator and cut its connecting nut off. Use a hacksaw to cut at the yellow mark. (fig 1.2)



Figure 1.2.

3. Take a tire's inner tube and cut the valve stem off, in such its lower part fits the nut. (fig 1.3).

4. Fit the valve stem into the nut precisely.

5. Apply epoxy from the outside to provide a strong adhesion between the valve stem and the nut and prevent the gas from leaking. Also apply a little of epoxy inside - Do not block the hole. Now the nut is ready to use with the tire barometer and the propane tank. (fig 1.4).



Figure 1.3.



Figure 1.4.

Now to connect the air tank to the propane tank.

Note: to be able to insert air into the propane tank, you should have the connecting nut illustrated in the photo. If the connector is unavailable, or buying it may draw attention to you, you can use a normal cooking gas regulator with a bit of modification. You will have to drill a hole from the inside to let Air pass into the cylinder.





With the two tanks connected, insert 3 bars of air into the propane tank. This will make the total pressure inside the Cooking Gas Cylinder 12 bars. The higher the gas pressure the stronger the explosion. Avoid heat and fire sources while inserting or discharging gas. Propane is very flammable.

1. Break the top of the decoration lamp by heating it. Make sure the filament does not break.
2. Fill the lamp with match-heads. (fig. 3.1).
3. Seal it with a tissue. (fig. 3.2).



Figure 3.1. Match in lamp.



Figure 3.2. Sealing.

4. Insert the lamp into the connector, while the wires are out.
5. Apply epoxy to seal the connector or the modified regulator.



Ignition lamp in connecting nut.



Ignition lamp in modified regulator.

6. Fasten the connector to the propane tank carefully. (fig. 4.1.).



Figure 4.1. Propane tank bomb.

6 closely kept 25-liter propane tanks will be enough for a car bomb that could kill large amounts of people in a crowd. Tape or glue shrapnel on the surface of the propane tanks and place shrapnel wherever there is space for it to be thrown out and into the crowd. The bombs will become much more deadlier and dangerous when using shrapnel!

Every ignition lamp has two wires. Connect the wires on the right to the positive pole (+) of the battery (12v or more), and the wires on the left to the negative pole (-). Here's how to set up multiple bombs (in a diagram):

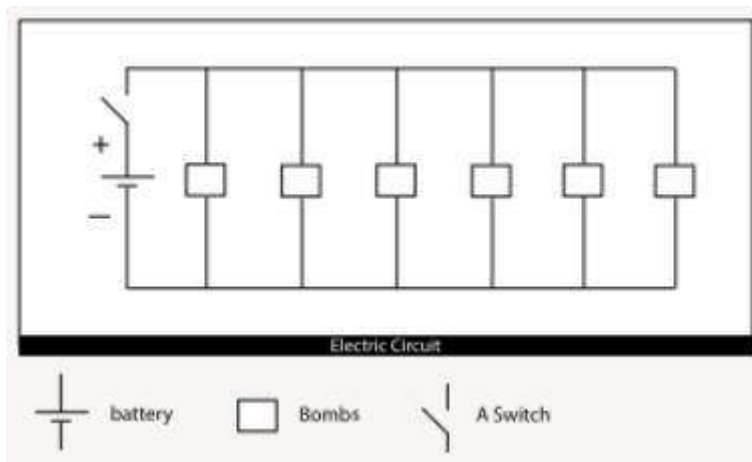

When these two wires are connected to the battery the bomb will explode. That is why you should put a switch on the positive side so that you can control when to detonate the bomb and protect the circuit from premature detonation. It is recommended to test this circuit without bombs first. The propane bomb could be detonated by a timing device or by remote control. Also, differently from movies and video games, the propane tank will not blow up when shot.

CHAPTER VII: OTHER CHEMICALS

Sulfuric Acid

Sulfuric acid can easily be bought or stolen from chemical/hardware stores. The concentrations it is bought in are low for explosives manufacture. Sulfuric acid can be boiled to raise its concentration to over 95%. This is because the other things in the sulfuric acid solution will evaporate. Always handle with rubber gloves.

Nitric Acid

Nitric acid is a powerful acid which is used for the production of many explosives. It is illegal to buy and synthesize in many regions without a permit. Yet, it is easily synthesized with widely available materials.

Material Required:

- Potassium Nitrate (2 parts by volume).
- Concentrated sulfuric acid (1 part by volume).
- 2 bottles or ceramic jugs (narrow necks are preferable).
- Pot or frying pan.
- Heat source.
- Tape.
- Paper or rags.

The amount of nitric acid produced is the same as the amount of potassium nitrate. Thus, for two tablespoons of nitric acid, use 2 tablespoons of potassium nitrate and 1 tablespoonful of concentrated sulfuric acid.

1. Place dry potassium nitrate in bottle or jug. Add sulfuric acid. Do not fill the bottle more than 1/4 full. Mix until paste is formed.
2. Wrap paper or rags around necks of two bottles. Securely tape necks of two bottles together. Be sure that bottles are flush against each other and that there are no air spaces.
3. Support bottles on rocks or cans so that empty bottle is SLIGHTLY lower than bottle containing paste so that nitric acid that is formed in receiving bottle will not run into other bottle.
4. Build fire in pot or frying pan.
5. Gently heat bottle containing mixture by gently moving fire in and out. As red fumes begin to appear periodically pour cool water over empty receiving bottle. Nitric acid will begin to form in receiving bottle.
6. Continue the above process until no more red fumes are formed. If the nitric acid formed in the receiving bottle is not clear (cloudy) pour it into cleaned bottle and repeat steps 2-6. If the nitric acid is red and fuming white, it has been synthesized at an exceptionally high concentration.

The reaction that has taken place here is: $\text{KNO}_3 + \text{H}_2\text{SO}_4 = \text{KHSO}_4 + \text{HNO}_3$

Piranha Solution

Piranha Solution, also known as piranha etch, is a mixture of Sulfuric acid (H_2SO_4) and Hydrogen peroxide (H_2O_2) used to clean organic residues off substrates. The mixture is a strong oxidizing agent that removes most organic matter, and it will also hydroxylate most surfaces (add -OH groups), rendering them highly hydrophilic (water compatible). Acid piranha is a 3:1 mixture of concentrated Sulfuric acid with 30% hydrogen peroxide. Also used is the base piranha, a 3:1 mixture of Ammonium hydroxide (NH_4OH) with 30% hydrogen peroxide. Both are equally dangerous when hot, although the reaction in the acid piranha is self-starting whereas the base piranha must be heated to 60 °C before the reaction takes off.

Caution: Piranha solution is extremely corrosive to organic material. Direct contact will burn skin and be extremely corrosive to mucous membranes, upper respiratory tract and eyes. Both liquid and vapor phases are extremely corrosive to skin and respiratory tract.

Caution: Piranha Solution is a very strong oxidizer when in contact with organic compounds.

Caution: Piranha solution is extremely energetic and exothermic, which may result in explosion if not handled carefully. Solutions made using hydrogen peroxide at concentrations greater than 50% may cause an explosion. Dissolving a large amount of organic contaminant will cause violent bubbling and a release of gas that can cause an explosion.

Preparation:

- Substrates should be cleaned, rinsed and dried before being placed in a piranha bath.
- Identify the location of the nearest eye wash and safety shower stations and verify they are accessible.
- Locate and verify that appropriate Piranha Solution spill cleanup materials and neutralizers are available.
 - Acid neutralizer (or alkaline neutralizer for base piranha solutions).
 - Scraper.
 - pH test strips.
 - Disposable scoop pan.
 - Polystyrene bag for waste collection or mayo jar.
- ALWAYS add the hydrogen peroxide to the acid very slowly, never vice versa. Hydrogen peroxide concentrations should be kept below 30% and should never exceed 50%.
- Always use glass (preferably Pyrex) containers. Piranha solution will melt plastic. Piranha solution should be used freshly-prepared, due to the self-decomposition of hydrogen peroxide. Do not maintain a stock solution of the Piranha mixture.
- Prepare small amounts of solution to be used for each application.
- Do not store wash bottles containing organic compounds on the same work surface as the piranha solution.

During work:

- Mix the solution in a fume hood with the sash between you and the solution. The solution may be mixed before application or directly applied to the material, applying the Sulfuric acid first, followed by the peroxide.
- Piranha solution should never be left unattended if hot.
- Never seal containers containing Piranha solution. Avoid using airtight containers as pressure can build up inside from the self-decomposition of hydrogen peroxide and oxidation products of organic compounds.
- Mixing hot Piranha solution with organic compounds may cause an explosion. This includes acetone, photoresist, isopropyl alcohol (other organic solvents), and nylon.
- Containers used during the etching process must be very clearly labeled and a warning sign, visible to any user working under the same fume hood, must be posted to indicate the working piranha solution, corrosive and explosive hazards, and contact information of person responsible for the piranha etching process.
- Piranha Solution is very energetic and potentially explosive. It is very likely to become hot, more than 100 °C. Handle with care. Picking up a beaker that is hot will be very painful, may melt your gloves, and may cause you to spill it.
- Do not transport solution around the room in beakers. Never pour chemicals back into the original container.
- Immersing a substrate into the solution should be done slowly to prevent thermal shock that may crack the substrate material.
- AVOID INHALATION! Perform all experimental operations within a fume hood or other approved ventilated enclosure. All handling of hot piranha solution must be done with clean glassware within a fume hood. Work with the sash as low as possible and never raise it above the indicated sash limit. Never remove hot piranha solution from the fume hood.
- AVOID CONTACT! Don appropriate personal protective equipment:
 - Lab coat, full-length pants and closed toed shoes
 - Safety glasses or goggles
 - Acid-resistant apron, gloves with extended cuffs, and face shield required when handling large quantities outside of the fume hood (>500mL) or where splashing is more likely.
 - ALWAYS work behind the fume hood sash, wear a face shield when working with fume hood sash open higher than 16 inches from the base.
- Recommended Glove Material: Rubber, Butyl, Neoprene, or Viton (regular Nitrile gloves will not provide appropriate protection).
- Recommended Gloves: Ansell Microflex 93-260 (Nitrile & Neoprene composite), Ansell AlphaTec® Solvex® 37-175 (Nitrile), Ansell AlphaTec® 38-514 (Butyl Polymer).

After work:

- Do not add any acids or bases to the solution once completed.
- Do not mix with organic waste compounds (e.g., acetone, methanol, isopropanol).
- DO NOT STORE PIRANHA SOLUTIONS! Oxygen released from self-decomposition and oxidation byproducts of organic compounds can cause the container to over pressurize and explode. Always mix a fresh solution.
- Leave the hot Piranha solution in an open container in a fume hood or ventilated enclosure until cooled.

- Allow hot piranha solution to cool down, put the waste solution in a cleaned and dried container with a vented cap. If vented cap is unobtainable, screw a regular cap on lightly to allow pressure relief and prevent over pressurization.

Spill response:

- In case of an incidental spill, use the acid neutralizing agent (or alkaline neutralizer if base solution) in your spill kit. Do not use combustible organic materials (spill pads or paper towels) to clean up the spill unless it has been properly neutralized, and pH tested to a safe range of pH=6-8.
- If the spill occurs outside the fume hood or ventilated enclosure, alert others and evacuate to a safe distance and prevent entry.
- If the spill occurs outside the fume hood, restrict access to spilled area from personnel and post signage indicating hazardous spill of corrosive and potentially explosive piranha solution in the entrance to the lab.
- If the spill occurs inside the fume hood and you are trained and confident, don PPE described above and apply acid neutralizer then pH test to a safe range (pH=6-8). Collect spill material and dispose as hazardous waste following the hazardous waste disposal guidelines listed above.

Napalm

Note: This section was largely written by "Koslo".

Napalm is a very flammable gel that sticks to things. There will be two different types of napalm that can be manufactured in these guides: 'Napalm (standard)' and 'Napalm (improved/ultra-thick)'.

Napalm (standard). Materials:

- Undissolvable (gasoline won't dissolve them) containers (glass pilot jars, pop cans, and 1-gallon paint cans are your best bet).
- Compressed-sphere styrofoam (little spherical bits tend to flake off when it's broken).
- Gasoline.

1. Take your gasoline and fill the containers approximately 3/4 of the way full (space must be allowed for foam dissolving and expansion).

2. Take styrofoam and break it into pieces that fit in the jar, and begin to insert them into the gasoline, giving them time to dissolve completely.

3. Feed styrofoam until the mix reaches the desired consistency. The most dense napalm can get is when the mix absolutely refuses to eat anymore styrofoam.

4. This is the part which makes it higher quality than what the other instructions provide. Allow the mixture to sit for 3-5 days, away from water or rain.

5. After the mixture has set (hard layer on top, possible visible separation of water and gel), take a rod and jab a hole through the hard layer on top. Then drain the water that has formed on the bottom, and now you have a good napalm mixture, though you may want to mix it a bit more to get it loosened and gelled again.

Napalm (improved/ultra-thick). Materials:

- Undissolvable containers.
- Styrofoam insulation (the pink, ultra-tough stuff).

- Gasoline.

Same procedure as the standard napalm. I am uncertain if this version needs a few days to set; mine set for a month.

Use wax soap or candles if there is not enough styrofoam. Peel off small shavings from the soap/candle using a potato peeler. Make them fingernail-clipping sized. Wax soap and candles contain lots of trash which will make the napalm less than optimal.

Napalm can be put into a flimsy bottle with a rag on it for an optimal Molotov cocktail. Remember to light the rag maybe with the help of some lighter fluid and then to throw the cocktail against a hard surface. The bottle will shatter and release the napalm which will be lit by the burning rag.

AMMONIUM NITRATE

Note: This section was largely written by Anders Behring Breivik.

Ammonium nitrate (AN) is a very popular fertilizer in the EU and elsewhere in the world, accounting for about 9 percent of all fertilizer used. Normally, you would need a minimum of 32% nitrogen in the fertilizer in order to create "an optimal detonation". However, 27% nitrogen fertilizers will do the job as well as long as you use a larger booster. A rather confusing factor regarding the nitrogen value; 27% nitrogen (for example labeled as 27-0-0) does NOT mean that there is only 27% AN content. In most, if not all, N-fertilizers you will find approx 80% AN content. In so called "CAN" fertilizer (Calcium Ammonium Nitrate) you will usually find approximately 75-80% AN and 20-25% Calcium. One source I found states the following:

If the Nitrogen in the NH_4NO_3 is 30-33% then you need 5-10 g of booster.

If the Nitrogen in the NH_4NO_3 is 20-25% then you need 15-20 g of booster.

Which indicates that lower purity nitrogen fertilizer will still detonate properly as long as you use a larger booster/blasting cap. For 50 kg of CAN (Calcium Ammonium Nitrate) I would use a 200-500 g booster. For 500 kg of can I would use a 500 g to 2 kg booster.

Calcium has been added to attempt to inert (make impotent) or to make the fertilizer non explosive. The good news is that it would require 80% Calcium mixed with 20% AN to make the fertilizer completely inert. The only thing they accomplish with adding 20% Calcium Carbonate is to make it a little harder to detonate. It will for example make it hard to properly detonate smaller charges of the fertilizer (>50 kg). This forces the handler to use larger amounts of fertilizer (<100 kg) and use larger boosters. CAN fertilizer (Calcium Ammonium Nitrate) is the best option when manufacturing explosives (unless you can get your hands on pure AN which is increasingly harder to acquire in large quantities). Also, according to a forum source, CAN fertilizer is the best option to use for purification of AN through crystallization.

Also, they have deliberately made the granules/prills less porous (they have compacted them) with the intention of making it harder for each granule/prill to easily absorb fuel oil. They have therefore made it harder for us to manufacture and prepare large quantities of AN explosives. However, this is easily bypassed by pulverizing the granules using a wood-roller on a wood board. It is a tedious task to pulverize 500- 2000 kg of CAN fertilizer but

the labor invested will be rewarded with a considerably more potent product. CAN fertilizer should be detonated under confinement or it may not detonate at all. Also, try to add as much, 400 mesh, flaked aluminum powder (up to 15% by weight) to nullify the desensitizing effect the 20% Calcium Carbonate has on the compound. Finer or coarser aluminum powder (atomized included) will work as well but 400 mesh, flaked aluminum powder is optimal, according to the book: Kitchen Improvised Explosives.

The following 4 fertilizers are so called N-fertilizers from the Norwegian fertilizer manufacturer Yara; one of the largest fertilizer manufacturers in the EUs inner marked. Important note: It is the N fertilizers that are suitable for manufacturing explosives, not NPK, NK, NP, PK, P or K fertilizers.

CAN N27 (CAN 27-0-0).

CAN fertilizer where the nitrogen consist of equal parts of ammonium and nitrate. Magnesium and calcium has been added into this mix in unknown quantities. Sold in a 500 kg bag. CAN is probably an abbreviation for Calcium-Ammonium-Nitrate.

27% nitrogen total (N) 13,5% nitrate/NO₃ and 13,5% ammonium/NH₄.
5% Calcium (Ca).
2,4% Magnesium (Mg).

OPTI KAS 27-0-0 (OPTI-KAS is a brand name of Yara).

CAN fertilizer where the nitrogen consist of equal parts of ammonium and nitrate. Magnesium and calcium has been added into this mix in unknown quantities. Sold in a 600 kg bag.

27% nitrogen total (N) 13,5% nitrate/NO₃ and 13,5% ammonium/NH₄.
4,3% Calcium (Ca).
2,4% Magnesium (Mg).

OPTI-NS 27-0-0 (4S) (OPTI-NS is a brand name of Yara).

27% nitrogen total (N) 13,5% nitrate/NO₃ and 13,5% ammonium/NH₄.
6% Calcium (Ca).
0,7% Magnesium (Mg).
3,7% Sulfur (S).

Sulfur-CAN 27-0-0 (4S).

27% nitrogen total (N) 13,5% nitrate/NO₃ and 13,5% ammonium/NH₄.
5,4% Calcium (Ca).
4,5% Sulfur (S).

I recently learned that the Norwegian agricultural supplier does indeed have purer forms of AN (34% nitrogen instead of the more common CAN fertilizer with 27%), so called: N34 fertilizer (34-0-0). They don't market it though and they only sell it in 600 kg bags. You should check with in your respective country whether this is the case or not. If no N34 fertilizer is available, then CAN27 fertilizer will work as well.

According to wiki CAN fertilizers (the two first alternatives, out of the four) contains approx 74% ammonium nitrate (NH_4NO_3) and 26% Calcium as Calcium Carbonate (CaCO_3). So even though the nitrogen level is stated as being 27% (very misleading) the total AN level of the fertilizer is 75-80%. It is a bit confusing, I know.

In its pure form: KNO_3 , ammonium nitrate can be detonated with a 6 dynamite cap at a blast radius of 14,000 feet per second. However, KNO_3 has become increasingly difficult to acquire.

CAN fertilizer that "looks right" might result in an inert compound as many substances are hard to fraction out as they were intentionally put there to prevent easy distillation. A small amount of Magnesium or Sulfur does not make the fertilizer inert. However, I don't have enough time to research which purification method that should be used to remove these compounds, if this is desirable.

Before buying the fertilizer check the composition of the mixture. 32(34)-00-00 is the absolute best option and can even be used without purification but unfortunately, the EU banned it. You need a minimum of 32% purity on the AN. The current mixes are only available in 27-xx-xx usually so it MAY require purification. Also, the most similar compounds are often not available in 50 kg bags, and only available in 600 kg+ large bags due to the EUs anti-terror laws. The EU will most likely ban "usable" AN fertilizers completely and force everyone to use Urea based fertilizers instead (46-00-00). The problem with urea (urea nitrate) is that it is much more unstable than AN with a significant decomposition rate. In addition, it is considerably more time consuming to convert Urea fertilizer to large quantities of Urea Nitrate (more than 100 kg) for one person. This in combination with the limited 30 day "shelf life" of Urea Nitrate limits its use significantly as an explosive. We may go down that road in the future, but at the moment, better options are available.

If fertilizer grade ammonium nitrate is to be used it may have to be purified first in order to maximize the effectiveness. I am not yet 100% sure which of the additives included in the various types of fertilizer will make the compound inert. To be sure you get a fertilizer type you can work with find a compound similar to the old classic: 32-0-0 (which the EU banned a few years ago). The reason they banned it was because you basically got a finished blasting agent. All you had to do was to add 7% diesel and you had ANFO, ready to use.

Each fertilizer has an analysis table that tells you the percent of nitrogen (N) - phosphorus (P_2O_5) - and potassium (K_2O) by weight. Urea is 46-0-0, and ammonium nitrate is 34-0-0. Both of these products contain nothing but nitrogen, but the nitrogen is at different percentages. Urea contains 920 actual pounds of nitrogen per ton, and ammonium nitrate contains 680 actual pounds of nitrogen by ton ($2,000 \times 46\% = 920$ and $2,000 \times 34\% = 680$).

Fertilizer grade AN bought in garden stores etc today are full of impurities like anti waking agents, ammonium sulphate, NaCl , $\text{Ca}(\text{NO}_3)_2$, sodium bicarbonate and other impurities.

The N-P-K numbers are a fertilizer convention for percentages of elements that plants need in fairly large amounts. These numbers aren't what you're looking for as a chemist seeking raw materials. What you want is an ingredients list. As for purifying this fertilizer, you'll have to look up what's in it, and how the impurities differ from ammonium nitrate,

before you talk about what purification method you've chosen. Unfortunately, there are several ways to purify/distill AN based on the compounds it is mixed with. Crystallization is one method of refinement but it doesn't work properly if there are certain compounds in the mix.

If the fertilizer is a mixture of ammonium nitrate, superphosphate (that's fertilizer jargon for $\text{Ca}(\text{H}_2\text{PO}_4)_2$) and trace metals (usually as chelates,) recrystallization can give you a pure solid. You will have to be sure any and all impurities are complete insoluble in water/ethanol/methanol /whatever to say that recrystallization is a good purification method. If that's not the case, you'll have to do fractional crystallization, an important beginner purification method in college classes.

Potential problems:

- Learn the solubility table on AN (NH_4NO_3) in hot methanol.
- Methanol is relatively expensive.

Purification

Crystallization using methanol (preferable): The following method will show you at least the best known purification method. This is done by boiling Methanol Alcohol and adding the fertilizer Ammonium nitrate until no more of it will dissolve. 20.2 g AN (NH_4NO_3) per 100 g methanol at 30 °C. There are values for other temperatures too, but solubility doesn't seem to vary rapidly. This is then cooled in an ice bath and the white crystals deposited at the bottom are pure Ammonium Nitrate. Thus the pure Ammonium nitrate can be heated on a lowest temperature on a pan in the oven until very dry. Store it in a tightly closed container.

Another similar method is the following: to purify "dissolve the fertilizer in hot methanol and filter the solution. By mixing the solution with an equal volume of unleaded gasoline, the ammonium nitrate will instantly crystallize."

Crystallization using water (try to avoid): It is possible to purify using simply water. You basically crystallize it from water as it has a solubility differential over temp in that. It is possible to remove many impurities by just dissolving it in boiling water. You will dissolve anything ionic. Filter it while really hot to remove insoluble's then let it cool and collect the AN. If you want really pure stuff, do a couple more recrystallizations to get out any remaining impurities. And NO! You do not need pure AN to make ANFO or ANNM. Believe me I have detonated enough ANFO full of sticks, sawdust, plastic chunks, and miscellaneous crap to know. However, if there are sodium compounds in there then they can't just dissolve in water and filter.

If you encounter problems try reducing the amount of water used or else reduce the temperature. Don't use boiling hot water. Try to get the temperature of the water to 50 °C. or so. This will reduce the yield but it will avoid some substances with a low solubility to dissolve. Ammonium nitrate dissolves 118g/100g water at 0 °C therefore reducing the temperature will still dissolve much of the nitrate.

Grinding

1. For small quantities you may simply use a rolling pin, the wooden kitchen tool used for rolling dough, on a wood base. However, if you want to pulverize large amounts of AN, 100 kg+, you want to use more advanced methods.

2. Commercial coffee grinders: dedicate one grinder for use on oxidizers. We don't want fires or explosions when we're grinding chemicals. Never grind complete or mixed compositions such as black powder in a coffee grinder. The AN should not react with any material in the grinder as long as you use steel blades.

I have found two kinds of coffee grinders: blade-grinders and burr-mills. Don't get a burr-mill; they don't work as well as blade-grinders (at least not for coffee beans, perhaps for AN prills). The blade-grinders have a stainless steel blender type blade that spins at high speeds in the bottom of the material cup, pulverizing the material in the process. When evaluating whether to use a smaller, less expensive, blade-type coffee grinders; know that they really don't last too long if you mill chemicals for a minute or two at a time. To use them, mill your chemicals in pulses of a few seconds at a time. Shaking them while pulse-grinding can give you even faster results. There are different types of coffee grinders. You may want to choose an espresso variant as it will produce a finer powder. However, expect this factor to result in a doubled grinding time.

Be careful of heat buildup. Avoid aluminum blades, use steel blades (it's usually steel as default). Avoid sparks. Quickly put in airtight container as powdered AN absorb water from air.

Grinding speed; depends on grinder. I did find an example from a commercial espresso grinder: 57 g in 20 seconds which equals 171 g per minute, 10,26 kg per hour. With this speed it would take 97,5 hours to grind 1000 kg of AN prills/granules. However, if you use a grinder constantly then expect it to only last a few hours. So you will probably need up to 10 grinders for 1000 kg prills. Expect the total amount of hours to exceed 200 hours as you don't want the grinder to overheat. I heard that Baader, the Marxist from Red Army Fraction bought tens of grinders as they regularly broke down. He even bought a really expensive one but that one broke down as well. They ended up using wood rollers resulting in limited amounts of end product.

3. I have not confirmed this method but it looks good in theory. An electric garbage disposal unit/food waste disposer/sink grinder, approx 370 W, 2600 RPM, cost: 200 Euro. No knives or blades. Instead, it is a rotating mechanism which presses the material out through small holes in the outer walls.

4. I have never seen this method mentioned in relation to AN prill grinding. However, theoretically, it sounds like a wonderful idea.

A barley crusher/malt grinder is used for grinding barley in micro-brewery operations (enthusiasts brewing their own beer etc). It is a mini grinding mill, a unit operation designed to break a solid material into smaller pieces.

There are two main suppliers of relatively inexpensive barley crushers;

<http://www.barleycrusher.com/>
<http://www.crankandstein.net/>

Of the two I would recommend the Barleycrusher with the following specs:

- Roller assembly: 1,25" diameter x 5 " length.
- Models: 7 lb (3,2 kg) or 15 lb (6,8 kg), go with the 15 lb.
- BC adjustment range: 0,015 to 0,070 thousands of an inch. Default set at 0,039. This is the way to fine tune your rollers, to adjust them so that you get finer powder etc.
- Rollers have: 12 TPI knurl.
- Comes with a solid base with locators to center the Barley Crusher on a 5 gallon plastic pail. (Pail not included).
- The standard hopper holds 3,2 kg and the optional large hopper holds 6,8 kg. Using a 3/8 drillmotor at 500 RPM gives you a crush rate of 2,7 kg per minute.
- The Barley Crusher is shipped fully assembled. There are no adapters needed to use a 3/8 drill motor.
- Cost: 15 lb variant, costs 115 USD with an additional 60 USD shipping.
- A hand crank is included but it is advisable that you use a drill (you just fasten the drill bit where the hand crank used to be).
- You will also want a high quality drill with adjustable speed (cheap version drills may be just as good as long as they have an adjustable speed). You want to use a relatively low speed (150-200 RPM). However, you should test and confirm this as higher speeds may be viable. You should not select a battery drill as each battery will only have enough power for 10-12 kg of corn (prills) according to one forum source. Buy a second hand, high quality drill on your local online marketplace or ebay. Just keep in mind that the US voltage (110-120 V) is different from the European (220-230 V).
- Example drill: <http://www.dewalt.no/powertools/productdetails/catno/D21520/>

5. Grist Mills for the crushing of barley or wheat are also effective (wind mill, water wheel, motorized or by using an ox). A ton of material can be processed through one this size in about two hours. Too bad this method is not an option for 99,99% of us.

6. Various electrical mixers may work.

Further Hints

If you are having problems converting fertilizer to a more pure form just try using some other source of ammonium nitrate, like cold packs, or another brand of fertilizer containing ammonium nitrate. The AN from Cold packs is however 10 times as expensive as the fertilizer AN resulting in a limitation regarding the procurement of large quantities.

The shelf life of cold packs (100% AN) is approximately 1-2 years from production date which is usually specified on each package. So, if you need a large quantity, start your acquisition phase approx 6 months prior to the execution of the mission. Note that the special plastic and vacuum packing is done to ensure this long shelf life so if you take out the AN from the cold packs it might influence the shelf life, regardless of how effectively you manage to contain it. If you are packing it yourself with traditional plastic the shelf life may be dramatically reduced, perhaps down to 4 weeks with poor packing. This will depend on how well you pack it, how much oxygen is available, humidity, temperature

during storage etc. Container: heat- OR acid- resistant OR plastic). Instead of storing a 500 kg (which might be poorly packed for long term storage) you should consider breaking the large bag into smaller 50 kg bags. Try to order specialized plastic bags for this purpose.

Caution: Never use copper or brass containers because ammonium nitrate reacts with these metals.

To test if fertilizer has ammonium nitrates use a sample and pour on top about half as much sodium hydroxide. Then add a small amount of water. If it starts bubbling and releasing ammonia gas then it has a high concentration of ammonium nitrate.

Before you call your farming supplier and make the actual order you should take the following precautions:

- Create a company with an appropriate name (preferably 1-2 years prior to first order).
- Join an interest organization for small/medium farmers.
- Join the organization related to the main agricultural supplier; create a company customer profile and register your organization number.
- Make the order as soon as possible and up to 6 months prior to delivery. For example; if you want the fertilizer bags delivered in May, order them in November. The agricultural supplier prefers early orders as they book your order into their distribution/delivery schedule. They deliver hundreds of thousands of tons of fertilizer annually so making an early order will not only save you money (as the prices are term based); it will likely ensure that you will avoid the scrutiny reserved to a larger degree for “more unknown customers” who wants “sudden large orders” of nitrogen-only bags.
- Ensure that you can provide a delivery address (where you want the big bags delivered). If you haven't yet rented a small farm/cottage you can explain to them that you are planning a test production next spring of a crop that requires the specified fertilizers you are ordering. • Create a credible cover story in case anyone asks why you are buying the fertilizer and how and when you plan to distribute it in your field. Do your due diligence and research basic farming methods and similar knowledge. For example, you should have the theoretical knowledge on how to disperse the fertilizer in your field and when and how to provide the water required, if rain alone isn't sufficient. You should familiarize yourself with the basic farm equipment and tools which is needed to distribute the fertilizer in your fields in case you are presented with “security questions” from your supplier.
- Consider to buy the actual seeds for the crop you have selected and inexpensive equipment together with the fertilizer purchase. This will strengthen the credibility of the transaction as it will act in your favor in relation to avoiding suspicion.
- Don't take the chance of only buying 2 bags of CAN27 or N34. Instead, consider making an order for for example: order 1 large bag of non-nitrogen fertilizer (perhaps even two) in addition to ordering 1 x 500 kg bag of CAN27 and 1 x 500 kg bag of N34. This will strengthen the credibility of the transaction as it will act in your favor when it comes to avoiding suspicion.
- Ensure that you have the required tools/facility in order to handle the delivery when receiving the order. If you ordered 3-4 bags (2 AN bags and 1-2 non-nitrogen “dummy bags”) you will need at least 3-4 wooden pallets (without metal nails), a jack that can handle weights up to 700 kg and a dry outhouse/garage with roof and

a large enough door measuring at least 5-10m². When the delivery man arrives you will ask him to place the bags on the pallets you have prepared. You will then use the jack to transport these pallets into your outhouse/barn/garage. When you have placed the 3-4, 500 kg bags inside you must cover the two nitrogen bags with a plastic cover (with straps) and ensure that the content is protected from moisture. Obviously, you don't need to worry about the 1-2 other dummy bags as you ordered them just for show.

Keep in mind that the status quo will adapt to this approach; perhaps as soon as after my (Anders Behring Breivik's) operation. So we risk that in the future; absolutely all farming companies will be likely to undergo extreme scrutiny. If this happens, we must adapt and create a new and modified strategy. This counter strike will be countered by the resistance by simply encouraging and advising ourselves to actually buy/rent a small farm and successfully run it/harvest and sell the crops for one year, prior to the operation. By choosing this approach we will successfully nullify the expected counter-strategy which the status quo will attempt to implement in order to adapt to the initial strategy I presented.

Farming For AN

The following short introduction is presented in order to prepare the bomber for the fertilizer acquisition phase of his operation. Bombers will establish a cover and must therefore learn the very minimum about agricultural practices. You must learn enough about agriculture in order to pass any scrutiny checks the fertilizer clerk may present in the form of questions. You must learn to think, dress and act like a farmer and become confident through study of agricultural practices and your agricultural cover. Before you move forward with the acquisition phase you must determine several factors when establishing the cover. You should rent a small isolated farm which has indoor/shed storage capabilities. It is optimal to place your "acquirement/storage base" in a rural area in a neighboring country if possible, as fewer red flags will be raised by the store clerks towards foreign nationals as they will assume you will bring the goods to your country immediately. Just keep in mind; not all nitrogen based fertilizers are suitable as a component to a fertilizer bomb.

"What type of crop will you grow, how large is your field, how much nitrogen based fertilizer do you need per hectare?"

You want to choose a fertilizer intensive crop for your cover which, in regards to a climatic context, can grow in your country. A property with 10 hectare (100 000 square meters), planting the crop; sugar beets, will have a fertilizer requirement of 1060-1360 kilograms during a one rotation (100-130 days).

Common crops vs. fertiliser intensity (The overview is American and from 2010 so it does not necessarily reflect crops in your region and time)

Crop	Euro per planted hectare	Percent of operating costs
Maize/corn	168	84
Sugar beets	158	40
Rice	148	43
Peanuts	131	38
Cotton	94	27
Barley	72	72
Wheat	67	78
Grain sorghum	62	50
Oats	57	74
Soyabeans	35	37
Potatoes	N/A	N/A

Source: USDA, Economic Research Service.

Top agricultural products:

Top agricultural products by individual crops (million metric tons) 2004 data

Sugar Cane	1,324
Maize	721
Wheat	627
Rice	605
Potatoes	328
Sugar Beet	249
Soybean	204
Oil Palm Fruit	162
Barley	154
Tomato	120

There are three types of different fertilizer nutrients which prices fluctuate considerably; nitrogen-, phosphate- and potash-fertilizer. Obviously, you will want certain nitrogen fertilizers. The prices of nitrogen fertilizers depend on the gas market so considering the fact that gas prices are crashing at the moment (2010) due to new technologies being introduced in the acquirement of natural gas from below ground, prices on nitrogen based fertilizers are plummeting.

Fertilizer prices

Year	Nitrogen Euro/10kg of nutrient	Phosphate Euro/10kg of nutrient	Potash Euro/10kg if nutrient
1978	0.75	0.75	0.38
1990	0.75	0.94	0.56
2002	0.75	0.94	0.64
2005	1.3	1.3	0.75
2008	2.07	3.38	1.69

1000 kg of nitrogen fertilizer costs approximately 620 Euros when buying in bulk.

Price is the average for April of each year when buying in bulk. Nitrogen prices are average prices of nitrogen nutrient in anhydrous ammonia, nitrogen solution, and urea.

Phosphate prices are the P₂O₅ prices of superphosphate. Potash prices are the K₂O prices of muriate of potash.

Source: USDA, Economic Research Service

Sugar beet is a plant whose root contains a high concentration of sucrose. It is grown commercially for sugar production. The European Union, the United States, and Russia are the world's three largest sugar beet producers, although only the European Union and Ukraine are significant exporters of sugar from beets. Beet sugar accounts for 30% of the world's sugar production.

Sugar beet is a hardy biennial plant that can be grown commercially in a wide variety of temperate climates. During its first growing season, it produces a large (1–2 kg) storage root whose dry mass is 15–20% sucrose by weight. If the plant is not harvested at this time, then during its second growing season, nutrients in the root will be used to produce flowers and seeds and the root will decrease in size. In commercial beet production, the root is harvested after the first growing season.

In most temperate climates, beets are planted in the spring and harvested in the autumn. At the northern end of its range, growing seasons as short as 100 days can produce commercially viable sugar beet crops. In warmer climates, such as in California's Imperial Valley, sugar beets are a winter crop, planted in the autumn and harvested in the spring.

Sugar beet is one of the most chemical-intensive crops and is a challenging crop to produce. Sugar beets are highly sensitive to pests, diseases, and weeds from the time of planting through harvest.

Beets are planted from a small seed; 1 kg of beet seed comprises 100,000 seeds and will plant over a hectare (10 000 square meters) of ground.

Today, mechanical sowing, herbicide application for weed control and mechanical harvesting have removed the reliance on numerous workers.

Harvesting is now entirely mechanical. A roto beater uses a series of blades to chop the leaf and crown (which is high in non-sugar impurities) from the root. The beet harvester lifts the root, and removes excess soil from the root in a single pass over the field. A modern harvester is typically able to cover six rows at the same time. The beets are dumped into trucks as the harvester rolls down the field and delivered to the factory. The conveyor then removes more soil.

If the beets are to be left for later delivery, they are formed into clamps. Straw bales are used to shield the beets from the weather. Provided the clamp is well built with the right amount of ventilation, the beets do not significantly deteriorate. Beets that freeze and then defrost produce complex carbohydrates that cause severe production problems in the factory. In the UK, loads may be hand examined at the factory gate before being accepted.

Sugar beet is an important part of a rotating crop cycle. Crop rotation is the practice of growing a series of dissimilar types of crops in the same area in sequential seasons for various benefits such as to avoid the build up of pathogens and pests that often occurs when one species is continuously cropped. Crop rotation also seeks to balance the fertility

demands of various crops to avoid excessive depletion of soil nutrients. A traditional component of crop rotation is the replenishment of nitrogen through the use of green manure in sequence with cereals and other crops. It is one component of polyculture. Crop rotation can also improve soil structure and fertility by alternating deep-rooted and shallow-rooted plants.

Crop rotation avoids a decrease in soil fertility, as growing the same crop repeatedly in the same place eventually depletes the soil of various nutrients. A crop that leaches the soil of one kind of nutrient is followed during the next growing season by a dissimilar crop that returns that nutrient to the soil or draws a different ratio of nutrients, for example, rice followed by cotton. By crop rotation farmers can keep their fields under continuous production, without the need to let them lie fallow, and reducing the need for artificial fertilizers, both of which can be expensive. Rotating crops adds nutrients to the soil, and dirt. Legumes, plants of the family Fabaceae, for instance, have nodules on their roots which contain nitrogen-fixing bacteria. It therefore makes good sense agriculturally to alternate them with cereals (family Poaceae) and other plants that require nitrates. A common modern crop rotation is alternating soybeans and maize (corn). In subsistence farming, it also makes good nutritional sense to grow beans and grain at the same time in different fields.

Crop rotation is a type of cultural control that is also used to control pests and diseases that can become established in the soil over time. The changing of crops in a sequence tends to decrease the population level of pests. Plants within the same taxonomic family tend to have similar pests and pathogens. By regularly changing the planting location, the pest cycles can be broken or limited. For example, root-knot nematode is a serious problem for some plants in warm climates and sandy soils, where it slowly builds up to high levels in the soil, and can severely damage plant productivity by cutting off circulation from the plant roots. Growing a crop that is not a host for root-knot nematode for one season greatly reduces the level of the nematode in the soil, thus making it possible to grow a susceptible crop the following season without needing soil fumigation.

It is also difficult to control weeds similar to the crop which may contaminate the final produce. For instance, ergot in weed grasses is difficult to separate from harvested grain. A different crop allows the weeds to be eliminated, breaking the ergot cycle. This principle is of particular use in organic farming, where pest control may be achieved without synthetic pesticides.

A general effect of crop rotation is that there is a geographic mixing of crops, which can slow the spread of pests and diseases during the growing season. The different crops can also reduce the effects of adverse weather for the individual farmer and, by requiring planting and harvest at different times, allow more land to be farmed with the same amount of machinery and labor.

The choice and sequence of rotation crops depends on the nature of the soil, the climate, and precipitation which together determine the type of plants that may be cultivated. Other important aspects of farming such as crop marketing and economic variables must also be considered when choosing a crop rotation.

After they are harvested, beets are hauled to a factory. In the U.K., beets are transported by a hauler, or by a tractor and a trailer by local farmers. Railways and boats are no longer used.

Each load is weighed and sampled before it gets tipped onto the reception area, typically a "flat pad" of concrete, where it is moved into large heaps. The beet sample is checked for:

- Soil tare - the amount of non beet delivered.
- Crown tare - the amount of low sugar beet delivered.
- Sugar content ("pol") - amount of sucrose in the crop.
- Nitrogen content - for recommending future fertilizer use to the farmer.

From these elements, the actual sugar content of the load is calculated and the grower's payment determined. The beet is moved from the heaps into a central channel or gully, where it is washed towards the processing plant.

Top ten sugar beet producers – 2005 (million metric tons)

France	29
Germany	25
United States	25
Russia	22
Ukraine	16
Turkey	14
Italy	12
Poland	11
United Kingdom	8
Spain	7
World Total	242

There is much more that can be learned about sugar beeches, but this is a simple introduction to where to begin. I would advise you get an agricultural handbook and read it a couple times to memorize the jargon of farmers. This will make you much more convincing when talking to the clerk. It may also get you to be able to give agricultural support in warfare, if the system has waned its power that much. This will make you a very good resource for the guerrillas.

PTFE (TEFLON)

Note: This resin is used in the manufacture of AP bullets. This section was largely written by Uncle Fester.

Teflon is DuPont's brand name for what is generically called PTFE or polytetrafluoroethylene. The patent has long since expired on this substance, so a variety of other manufacturers now also make this material under different brand names. Teflon is a polymer with the following structure:

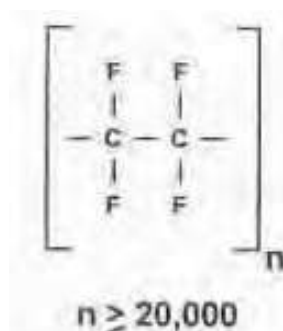

The tetrafluoroethane unit shown is linked together in chains 20,000 or more units long. The coloring doesn't affect the properties or

performance of the coating. Teflon resin suitable for coating metal is generally sold as emulsion of the Teflon polymer. The Teflon in this mixture floats around as small globules, which tend to settle to the bottom of the container over time. As a result, Teflon emulsions should always be stirred up prior to use. Violent mixing techniques must be avoided as this can cause irreversible coagulation of the small (size .05 to .5 microns) globules of Teflon resin in the emulsion. If one has a gallon jug of Teflon emulsion, the best way to get it stirred up prior to use is to tip the jug upside down, then right side up, a number of times over a two minute period. A five-gallon pail is best agitated by rolling it around on the floor for a few minutes. The Teflon-loaded paints sold under the trade names of Xylan and Everlube can be stirred or otherwise agitated, with a good deal more gusto than the pure Teflon coatings supplied by DuPont.

Not everything sold on the market as a "Teflon coating" produces a film of any value. The most important factor in determining a quality Teflon coating is the percent of Teflon resin actually contained in the emulsion. One product, called RO-59, contains so little Teflon that the coating is invisible, as are its benefits. When picking up a Teflon emulsion containing an unknown amount of Teflon resin, one can get a close estimate of the amount of Teflon resin it contains by weighing it to determine its specific gravity, i.e., how many grams a ml of emulsion weighs. A 100 ml volumetric flask, and an accurate scale, result in a very close approximation of the specific gravity. The following table correlates specific gravity to percent of solids and grams of solids per milliliter.

% solids	sp. gr.	gram solid/ml
35	1.24	.436
40	1.29	.515
45	1.34	.601
50	1.38	.693
60	1.50	.900

All of the information contained in this section is of little value if one isn't easily able to obtain Teflon resin emulsions suitable for application to metal surfaces. Luckily, this isn't the case. Teflon resin emulsion is widely available from quite a variety of sources. Further, the possibility that it may be put to nefarious uses isn't even a thought in the minds of those who distribute it. This situation isn't likely to change in the future, barring a massive media campaign against the evils of Teflon.

In a perfect world, Teflon resin emulsion would be sold on hardware store shelves, and available in bottles and aerosol cans. This isn't the case. My True Value hardware-store man laments this situation, as he says that he's been trying to find an aerosol spray Teflon for years to use in his lock department. Some hardware store products contain Teflon in combination with other lubricating ingredients, but none of them produce an adherent coating of Teflon. Given the wide variety of household or shop uses to which Teflon could be put, this is a clear marketing oversight. No doubt there is some technical difficulty making the packaging of aerosol Teflon inconsistent in its performance. Otherwise, it would be a clear winner. Just think of coating the bottom of your kid's snow saucer or sled runners or toboggan with some Teflon, to get that added speed in the snow. Ditto for skis — snow, water or jet. The list could go on and on. Would a boat cut through the water

better with Teflon coating? The number of probable good uses is limited only by the imagination.

Lacking a suitable hardware store product with which to apply a Teflon coating to bullets, how does one obtain Teflon resin emulsion without anyone thinking that a dastardly scheme is somehow being put into motion? There are a couple of ways to come at this problem, and my years of experience in the metal-finishing field tell me that both of them will work with no hassles or suspicion involved.

Plan number one is to show up “jug in hand” at a plant which is in the business of applying Teflon to metal, and talking them into selling you a gallon or so of their resin emulsion. This very low-profile and anonymous procedure has what I would estimate to be a 50-50 chance of success at any particular plant. The small, less bureaucratic business is more likely to be agreeable than the large outfit because people in the smaller plant will be more used to making decisions themselves without passing the buck. The person you talk to when you walk in the door is likely to be able to make the decision of whether or not to give it to you, or will be at least able to yell into the rest of the office to get your reply. There is one factor which will nag at the back of their heads, and produce some hesitance in selling you some resin. This is the hazardous-waste laws. Most plants which apply Teflon to metal do it as a sideline to the main business, which is plating metal. These guys have been shell-shocked with a real blitz of environmental laws over the past 20 years or so. They are literally afraid to fart for fear of being in violation of some environmental regulation. They may wonder if parting with some of their resin could be considered illegally disposing of hazardous waste. Of course, it's not a violation of any law. First of all, the Teflon isn't hazardous. Secondly, it's not waste, since you are going to be putting it to use. Such clear logic may be of no use at some places. That's the major reason why I estimate the probability of success at any particular plant at about 50-50.

Research if the target has Teflon. Then just show up at the front door of one of these plants, “jug in hand.” It would be best to avoid the homeless bum look, the escaped-nut look, or anything else which may turn them off on you, or cause them to worry about your safety when handling Teflon resin. Then merely ask at the front desk about obtaining some of their Teflon resin emulsion. They are likely to ask what you want it for. This question is a combination of curiosity and a desire to do whatever job you have planned for it themselves, and thereby making more money. The proper reply to their query is “workshop and home tinkering,” along the lines I listed earlier in this chapter, such as experimenting with coating snow- saucer bottoms, skis or even boat hulls. They will be impressed with your ingenious nature and self- motivation. They may even question your ability to use the emulsion, and may quiz you a bit. All the information you need to use Teflon emulsion is in this book. Study it before shopping. One thing they will not do is suspect that you want to coat bullets with it. Be nice, calm and answer any questions they may have without giving the impression of evasiveness.

Once you have made the deal (\$100-\$200 per gallon is in the reasonable range), it would be best to pay in cash to maintain the anonymity of the situation. When your jug is filled, cap it securely and be sure to use it all up within the afore-mentioned shelf life. Additional information, such as the brand of emulsion, its percent of solids, etc., may be had by asking for a copy of the Material Safety Data Sheet (MSDS) as you head out the door. By law, they should be giving that to you when they transfer the material, but don't make it a big point, or act like a smarty-pants. You got it from a plant that's in the business of coating

metal with Teflon, so you can assume that it's suitable for the purpose. The lone exception to this rule is if the plant is using the multiple-coat type of Teflon (i.e. primer, midcoat and top-coat), or a composite such as SilverStone. If this is the case, you should forget about that particular plant, if that's the only type of Teflon resin they have. Try the next one of the list. You will hit the jackpot at one of them.

If your particular area has no shops which apply Teflon to metal, or if they are so few in number that the "jug in hand" plan comes up with nothing there is an alternative method by which to obtain Teflon (PTFE) emulsion. This is to contact the manufacturer directly and buy some. At the time of this writing in mid-96, there is no problem in doing this. There are no laws regulating the distribution of Teflon resin, nor is there a well-rooted bed of suspicion out among the industry that their product would be put to other than conventional uses.

I have found three manufacturers/distributors for Teflon (PTFE) in the U.S. There may be more, but these three have the sense to advertise. Ordering from all three is pretty much the same — not difficult. They have a product, and they want to sell it.

CHAPTER VIII: TRIGGER MECHANISMS AND BOMB DESIGNS

Detonator

A detonator (also called a blasting cap) is a small sensitive primary explosive device usually prepared with no more than 6-30 grams of primary explosives. They are generally used to detonate a larger, more powerful and less sensitive secondary explosive. The detonator itself could be a plastic straw neatly inside of metal tubing or a rolled up piece of paper (less preferable). Just ensure that the activation of the detonator will be enough to detonate the rest of the explosives.

Most blasting caps contain what is called a primary explosive. A blasting cap may also contain a booster, another explosive to make the cap more powerful, and thus more reliable for detonating secondary stable explosives. Primary explosives can detonate by the action of a relatively weak mechanical shock or by a spark; if used in the form of blasting caps, they initiate the booster which then initiates the main explosive. They are also filled in percussion caps mixed with friction agents and other components. An initiating explosive must be highly briscant and must have a high triggering velocity. The most important/popular primary explosives are Mercury(II) Fulminate, DDNP (diazodinitrophenol), Acetone Peroxide (TATP), HMTD (Hexamethylene Triperoxide Diamine), and Lead Azide.

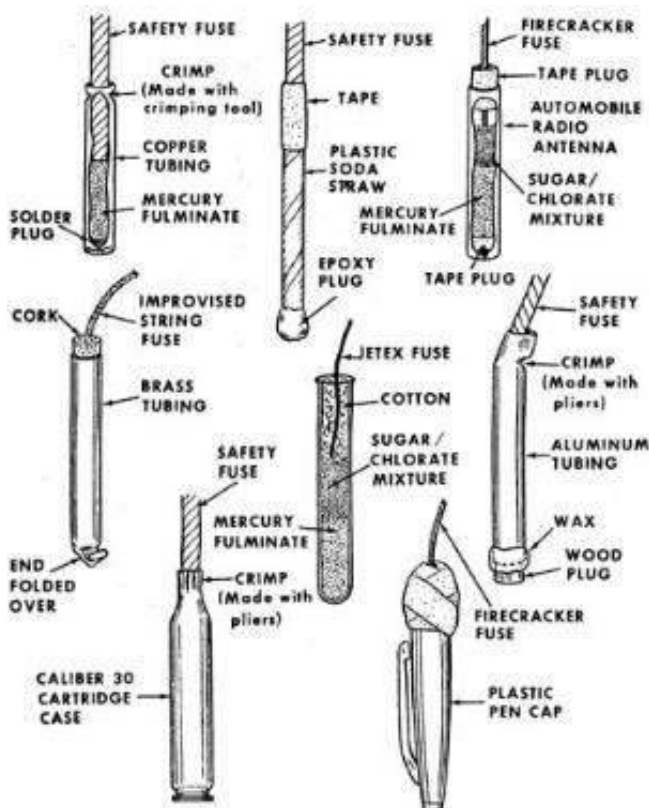

Various improvised detonators.

The recommended primary explosive is DDNP because it's non toxic, easy to make and not too sensitive. The sensitivity of DDNP to friction is much less than that of mercury fulminate, but it is approximately that of lead azide. DDNP is used with other materials to form priming mixtures, particularly where a high sensitivity to flame or heat is desired. DDNP is often used as an initiating explosive in propellant primer devices and is a substitute for lead styphnate in what are termed "non-toxic" (lead free) priming explosive compositions.

Improvised blasting cap shell construction is certainly not limited to copper and aluminum tubing. Lengths of automobile radio antenna (chrome-plated brass); plastic bodies of ball point, felt tip, and fountain pens; thin-walled brass tubing used by model makers; plastic soda straws; glass test tubes; and many other materials have been successfully employed as

improvised blasting cap shells with excellent results.

Once the shell has been plugged at one end, the primary high explosives are carefully placed into the shell and lightly packed or tamped with a rod. This procedure is not overly hazardous so long as a wooden rod is employed to press the explosive into the tube and the explosion will only be from 6-30 grams of explosives. Loose crystals of mercury fulminate have an apparent density (gravimetric density) of about 1.75.

When employed in commercially manufactured blasting caps, mercury fulminate is compressed to densities of approximately 2.5 to 4.0 under a pressure of about 3,000 pounds per square inch. This density will produce a detonation velocity of about 4,000 meters per second. Mercury fulminate is not more sensitive to heat, flame, spark, or shock after compression than in loose crystal condition, but the increased density produces a higher detonation velocity which increases its efficiency.

Generally no real attempt at density increase is attempted by the manufacturer of improvised blasting caps. The crystals are simply tightly packed into the shell container. So long as the manufacturer contents himself with tamping or compressing the explosives with a wooden rod or dowel no real danger exists, and space will be conserved within the shell.

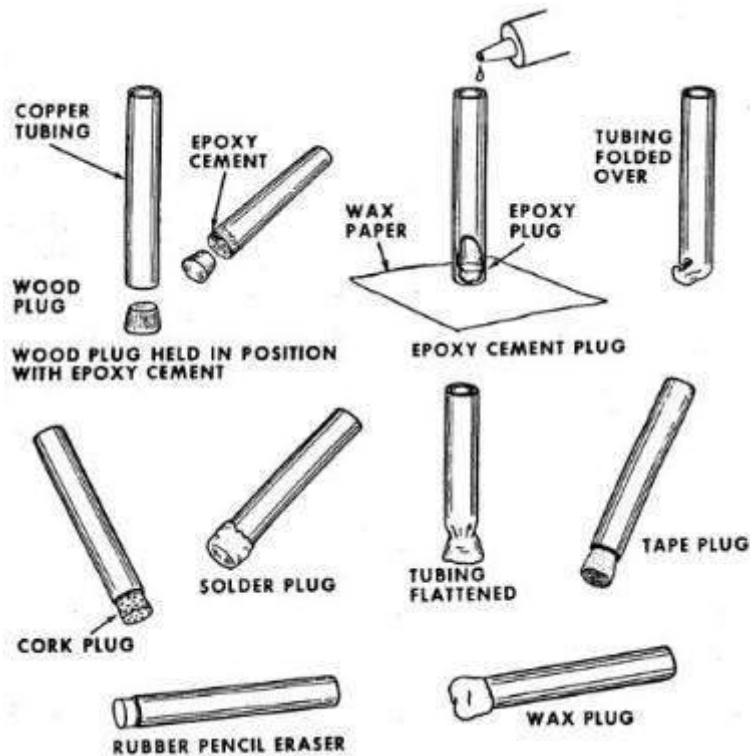

Once the shell has been loaded with the explosive, it is a simple matter to insert a length of commercial safety fuse into the copper or aluminum tube until it makes contact with the tamped crystals. Once in place, the soft tubing may be crimped lightly around the fuse with a pair of pliers, or the two units may be taped together. In instances where the shell of the improvised blasting cap is made of plastic or glass, tape or cement will be employed to join the safety fuse to the cap shell.

There are multiple techniques to ignite detonators. Some are cheap but limited and others are very effective but expensive.

Fuse

The oldest form of explosive ignition, fuses are perhaps the favorite type of simple ignition system. By simply placing a piece of waterproof fuse in a device, one can have almost guaranteed ignition. Modern waterproof fuse (such as visco fuse) is extremely reliable, burning at a rate of about 2.5 seconds to the inch. It is available as model rocketry fuse in most hobby shops, and costs about \$3.00 for a nine-foot length. Fuse is a popular ignition system for pipe bombers because of its simplicity. All that need be done is light it with a match or lighter. If desperate, the fuses from a firecracker or a firework could be dissected.

Decorative Lamp Detonator

We will proceed to break the top of the lamp by heating it. Make sure the filament does not break. The filament is the part which when electricity passes through it, it glows and produces light. The detonator will be placed in the lamp when it is assembled to the bomb.

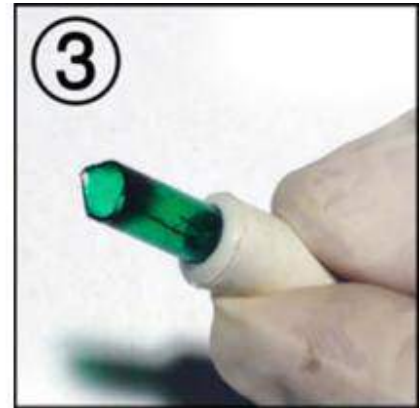

1. Heat the head of the lamp until it becomes black.
2. Place the lamp immediately in water while it is still hot.
3. Strike the tip of the lamp and it will break.

The importance of the electricity source in the explosive device is that it is the key in igniting the device. The electricity that is sufficient to turn on the small lamp is sufficient to cause the explosion. This electric current may reach to the lamp directly through a battery, by a timed circuit or by a remote controlled circuit. It is the optimal improvised electric detonator.

The example circuit is composed of:

- A 9V battery.
- A wire connected to the "+" of the battery and a nail (the red wire).
- A wire connected to the "-" of the battery and a test lamp (the black wire).
- We connect from the other pole of the lamp a green wire. When this wire touches the nail the circuit is closed and the lamp should light.

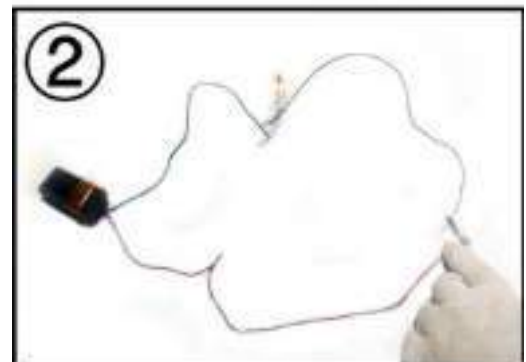

Note: the colors of the wires here are for demonstration purposes.

Place the primary explosives inside the lamp while it is disconnected to prepare the lamp. When it turns on it will ignite the detonator. In the example circuit the detonator would ignite when the nail touches the black wire.

Mercury Switch

Mercury switches are a switch that uses the fact that mercury metal conducts electricity, as do all metals, but mercury metal is a liquid at room temperatures. A typical mercury switch is a sealed glass tube with two electrodes and a bead of mercury metal. It is sealed because of mercury's nasty habit of giving off brain-damaging vapors. The diagram below may help to explain a mercury switch.

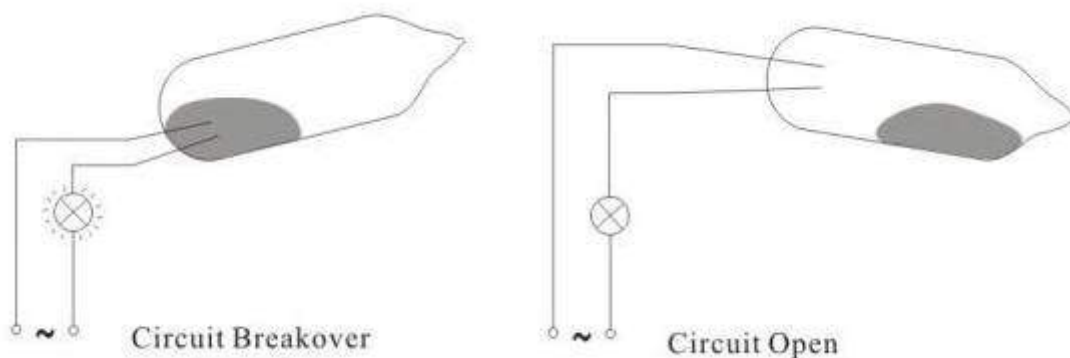

When the drop of mercury ("Hg" is mercury's atomic symbol) touches both contacts, current flows through the switch. If this particular switch was in its present position, A---B, current would be flowing, since the mercury can touch both contacts in the horizontal position.

If, however, it was in the | position, the drop of mercury would only touch the + contact on the A side. Current, then couldn't flow, since mercury does not reach both contacts when the switch is in the vertical position. This type of switch is ideal to place by a door. If it were placed in the path of a swinging door in the vertical position, the motion of the door would knock the switch down, if it was held to the ground by a piece of tape. This would tilt the switch into the horizontal position, causing the mercury to touch both contacts, allowing current to flow through the mercury, and to the igniter or squib in an explosive device. Imagine opening a door and having it slammed in your face by an explosion.

Tripwire Switch

A tripwire is an element of the classic booby trap. By placing a nearly invisible line of string or fishing line in the probable path of a victim, and by putting some type of trap there also, nasty things can be caused to occur. If this mode of thought is applied to explosives, how would one use such a tripwire to detonate a bomb. The technique is simple. By wrapping the tips of a standard clothespin with aluminum foil, and placing something between them, and connecting wires to each aluminum foil contact, an electric tripwire can be made. If a piece of wood attached to the tripwire was placed between the contacts on the clothespin, the clothespin would serve as a switch. When the tripwire was pulled, the clothespin would

snap together, allowing current to flow between the two pieces of aluminum foil, thereby completing a circuit, which would have the igniter or squib in it. Current would flow between the contacts to the igniter or squib, heat the igniter or squib, causing it to explode.

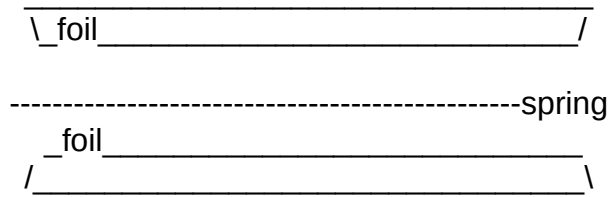

Insert strip of wood with trip-wire between foil contacts.

Make sure that the aluminum foil contacts do not touch the spring, since the spring also conducts electricity.

Door Trap

Door trap bombs are designed to detonate when the target door is opened. These are great for assassinations or as booby traps. Ensure that no guerrillas will accidentally open the door.

Materials:

- 2 strong solid wires (single-strand).
- 9v battery.
- Toggle switch.
- Decorative lamp/detonator.
- Bomb.
- Cloth hook.

1. Take 2 strong solid wires and shape them as seen in figure 1. Insert one of the wires into the other as seen in figure 2.



Figure 1.

Figure 2.

2. Now we connect the electric circuit as shown on the next page.

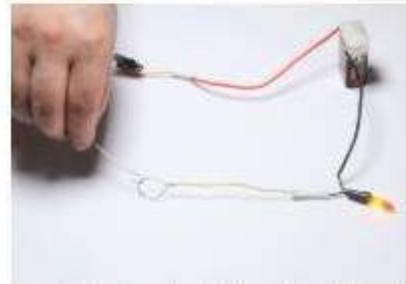
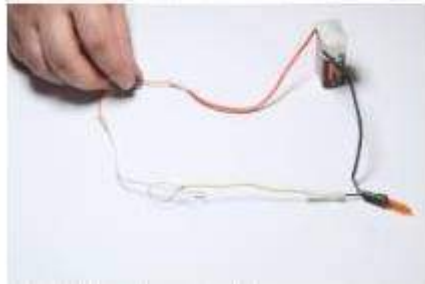
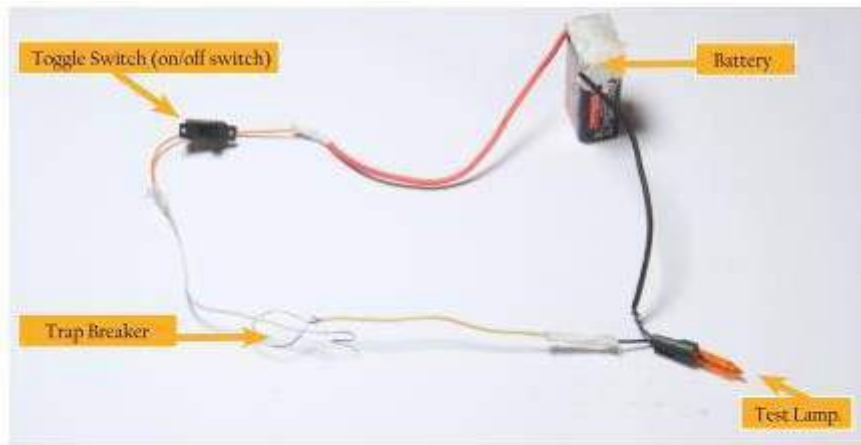

3. Switch on the toggle switch.

4. Pull the trap wire. If the test lamp lights this means that the circuit is OK.

5. Set up the door trap bomb.



Note: step 6. and 7. in the guide are about which bombs and detonators were going to be used by the guide. This is not important for the reader, as this will have little effect.

When the fuse ignites it will take approximately 3 seconds for the bomb to explode. This is enough to make the body of the person to be in the target area i.e. outside of the door, thus making all of his body vulnerable to the explosive effect.

Time Bomb

Materials needed:

- A 9V battery.
- A wire connected to the “+” of the battery and a nail.
- A wire connected to the “-” of the battery and a test lamp.
- We connect from the other pole of the lamp a wire. When this wire touches the nail the circuit is closed and the lamp should light. The lamp will become the detonator.
- An analog clock.

Note: the colors of the wires here are for demonstration purposes.

To set the clock. Connect the green wire which is connected to the lamp to one of the clock arms. Insert the nail into the clock face. This way when the arm of the clock moves it will touch the nail and the lamp would light.



1. Disassemble the clock.

2. If you want to set up the explosion to occur within an hour, cut off the arms of the clock except for the minutes arm. If you want more than an hour, you cut off all arms except for the hour one.

3. Make a hole in the face of the clock and insert the nail.
4. Insert the through the hole and connect the green wire to the hour arm. Make another hole if necessary for the green wire.

1. Figure 1 displays the electric circuit in the clock when the hour arm hasn't touched the nail.
2. Figure 2 displays the electric circuit in the clock when the hour arm has touched the nail, lighting up the lamp.
3. Now disconnect the test lamp from the circuit and connect instead of it the two wires coming out of the bomb. When the circuit is connected as in step two, the device would explode. You may hide the 9V battery inside the clock if you want to.

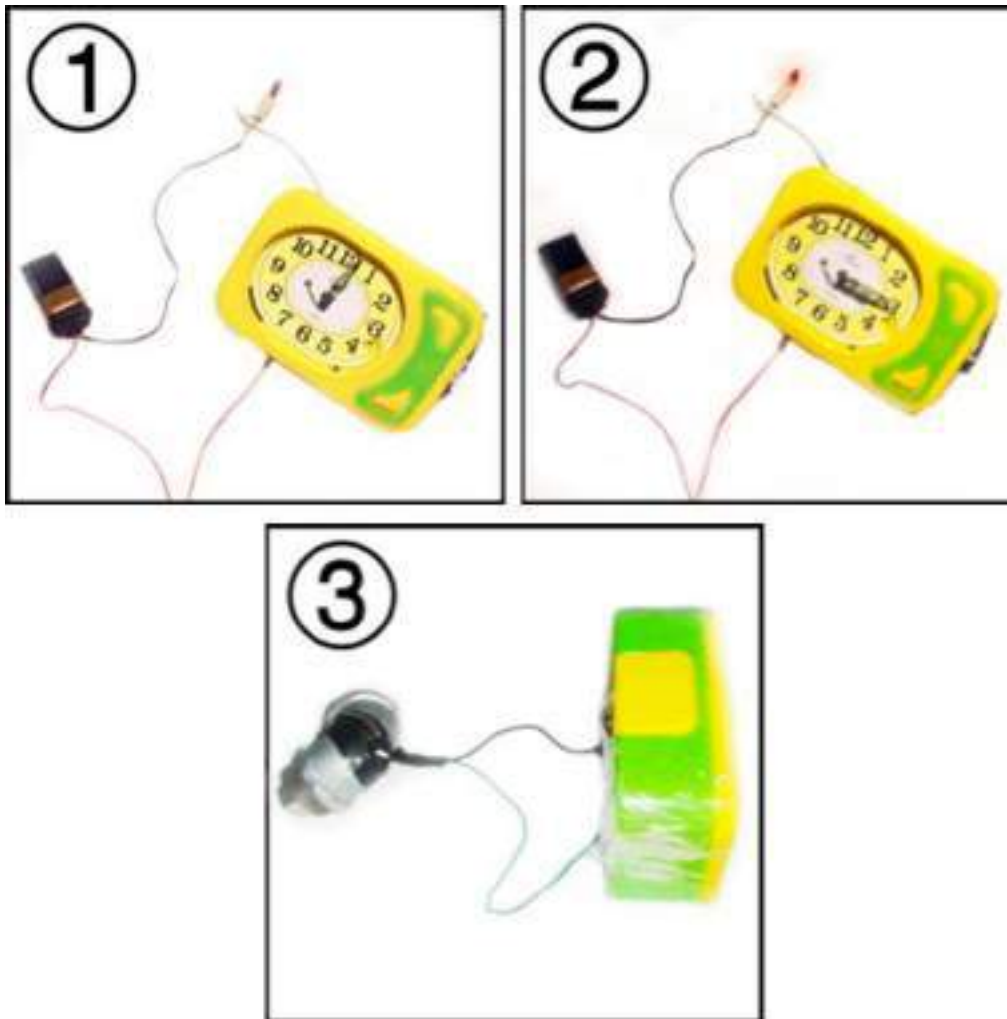

Take notice of the following:

- Make sure to cover all wires and also cover the battery in order to prevent any unwanted electric connections.
- Test the clock at least ten times on a test lamp to make sure it is working properly.
- It is better to use a small clock if concealment is important to you.

Remote Control Bomb

Detonating your explosive device can be done using many methods. We have already discussed about timing devices. When the time you chose is hit by the hour hand, the bomb detonates. This is ideal if you are trying to get as far away as possible from the scene. Its downside is that it is completely oblivious to the situation on the ground that may require an immediate or delayed detonation. The evident solution to that is to make the human being in control of the timing. In this section, we will explore how to make your own remote detonation device.

For the experiment, we purchased a motorcycle alarm set that is in the price range of fifteen to thirty dollars. What you will need for this experiment is the remote, the receiver, alarm speaker's wire, one 9V battery or more depending on your need, a 9V battery connector, a small lamp light, pliers, screwdriver, washing machine timer, duct tape and a digital multimeter. The use of the washing machine timer is recommended. Its main purpose is to provide safety on the receiver. We will be discussing this in later steps.

The following comes in the box:

- Remote.
- Receiver.
- Alarm speaker's wire.

The following is separate:

- One or more 9V batteries.
- 9V battery connector w/wires.
- Lamp light.
- Pliers.
- Screwdriver.
- Washing machine timer.
- Duct tape.
- Digital multimeter.



It is important to remember that we are using an alarm device for a motorcycle. If you use a car's alarm, you may or may not be able to follow our directions precisely

depending on what you buy. The benefit in using the motorcycle alarm is that it is cheaper in contrast to the car alarm which is more expensive but has a greater range.

Throughout the remainder of the instructions, the positive (+) is in reference to the red wire whereas the negative (-) is in reference to the black wire.

Do not use an analog multimeter. They can cause the bomb to detonate upon hook-up.

The two yellow wires should be the wires for the lamp connection. If this is not the case for you, then after cutting the wires from the plastic connection as in Step 2, you strip the coating off of them and test out which one of them has a voltage (through the use of the multimeter). When you find those two wires, you will use them to connect to the lamp.

1. Take the alarm speaker and clip the wires off of it. Then do the same for the receiver wires that connect to the alarm speaker as seen in Figure 1.2 on the following page. This will leave you with the two wires. Strip the coating of the wires ends using the pliers. Keep them aside for now.
2. Cut all the wires from the plastic connections that are attached as seen in Figure 1.4.
3. Figure 1.5 shows the red wire going through the plastic connection; this is the positive (+). Inside the plastic connection is a fuse that we won't be using, so proceed with cutting it out as seen in Figure 1.6.

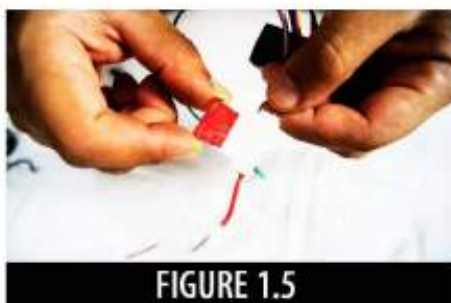

4. Figure 1.7 below displays two yellow wires. If they are not yellow in your set, then know that the two wires with the same color are usually the ones you need. Obviously you would need to test to verify that this is the case because different makers of remote controls



could have different specs.

Figure 1.7: In the manuals of three remote control sets that we possess, we always found that the two wires with the same color are the ones we needed and according to the manuals, these were to be connected to the right and left signals of the car or motorcycle.

5. After confirming which wires are needed, cut off the rest as seen in Figure 1.8. Make sure to leave the antenna intact since it is the wireless signal to your remote. The antenna in this remote is the green wire. In other remotes it could be a rod instead of a wire.



FIGURE 1.8



FIGURE 1.9



FIGURE 2.0



FIGURE 2.1

6. Wrap duct tape around the tips of the wires.

7. Remove the coating from the wires and twist them as seen in Figure 2.0.

8. Cut the 9V battery connection as shown in Figure 2.1.

9. We will now incorporate the battery connector into our steps and connect it with the receiver. Do that by wrapping the positive (+) of the battery connector to the positive (+) of the receiver. Then wrap the negative (-) of the battery connector to the negative (-) of the receiver as seen in Figures 2.2 and 2.3.

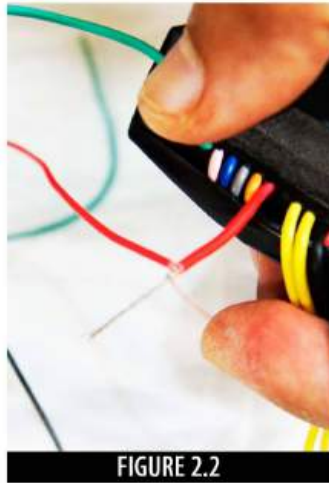

10. As shown in Figure 2.4 for the plastic connection that we had previously cut from the receiver, wrap one of the wires (it doesn't matter which one) of it to the negative (-) of the battery connector and the negative (-) of the receiver. That way, the negative (-) coming from the plastic connection is connected to both the battery connector and receiver as seen in Figure 2.5. Then with the other wire from the plastic connection, wrap it with either one of the yellow wires as shown in Figure 2.6 or with both. The benefit of using both yellow wires is two-fold. Firstly, it will give the circuit more voltage. Secondly, if one of the wires is defective, the other would suffice.

11. Wrap the wires from the alarm speaker that we had earlier cut off with the lamp light as seen in Figure 2.7.

12. Figure 2.8 shows duct tape wrapped on all the exposed wires.

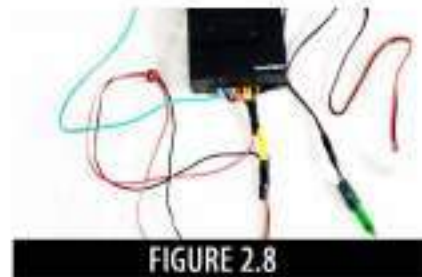

13. Connect the male plastic connection from the receiver to the female plastic connection from the lamp light as shown in Figure 2.9 below.

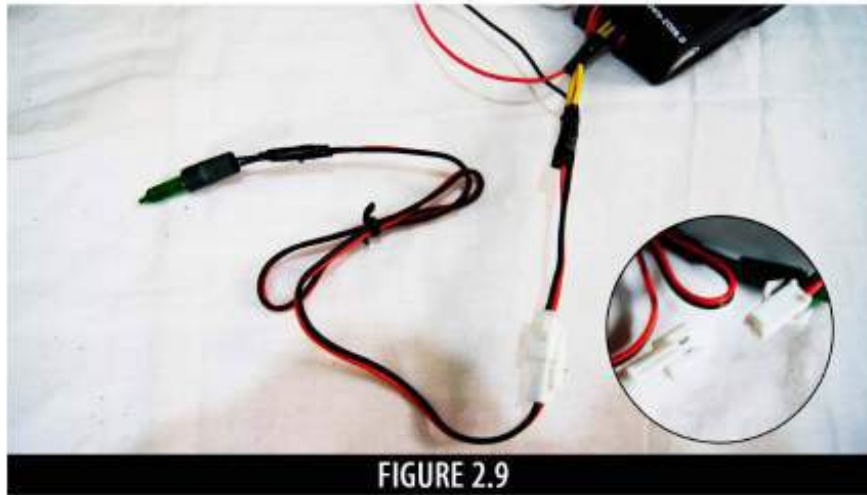

14. Connect the battery connector to the 9V battery. Press the unlock button on the remote for testing. If the connection is right, the lamp will light as shown in Figure 3.0.

15. To increase the voltage, increase the number of batteries. Figure 3.1 shows how to use three batteries. Use duct tape to ensure the stability of the batteries. When testing, notice the difference in the light between Figures 3.0 and 3.1. This ends the general assembly of the remote control detonation. It is now ready for use but there are further steps to take for the purposes of safety and ease.

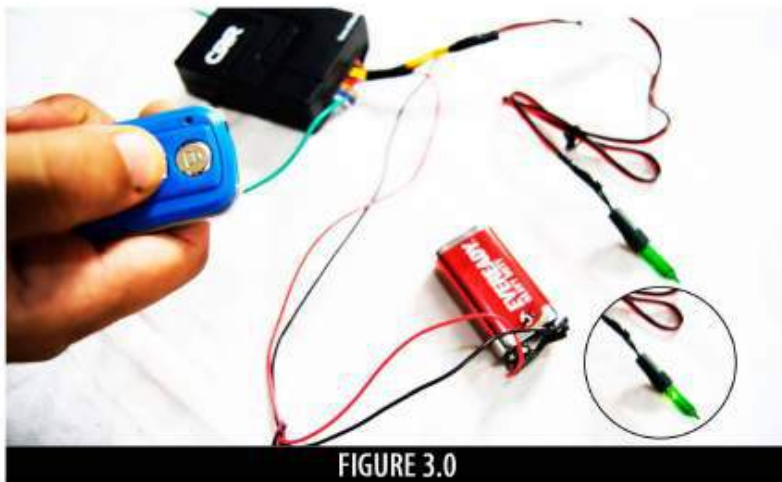

The multimeter or voltmeter helps in discovering any defects in the circuit. Hook it up in replacement of the lamplight to test the circuit. You need to place the dial as shown in the zoomed image above. If you want to test the batteries, then move the dial to 20 DCV.

To prevent accidental pressing of the buttons thus causing an unwanted detonation, then follow the images shown below. Unscrew the remote, remove all buttons except the unlocking one, and do the same for the buttons on the circuit board.



FIGURE 3.2

A washing machine timer is used for safety on the receiver; it is what keeps the circuit connected and disconnected. It can also take the place of the remote and act as a timer for detonation. The timers shown in Figure 3.3 give a five-minute delay. Bombs can explode accidentally when there is no timer involved. Friction can be enough to detonate the device.



FIGURE 3.3



FIGURE 3.4

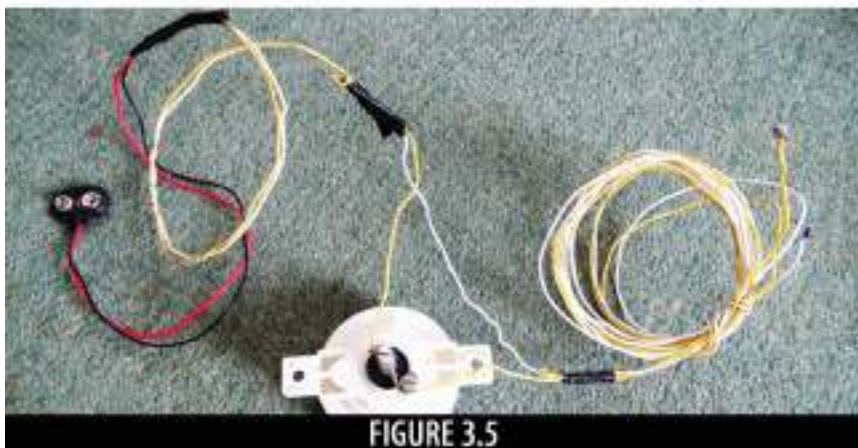

FIGURE 3.5

1. Screw a nail into the timer as shown in Figure 3.4.
2. The yellow wire that is going from the battery connector to the receiver is cut in the middle. One end of the wire is connected to the screw and the other is connected the metal rod protruding from the knob. The timer in this configuration serves as a terminator of the circuit. Refer to Figure 3.5.
3. Connect the wires as shown in Figure 3.5 (white is negative (-) and yellow is positive (+)). Notice that the cut must be in the positive (+). That is because the negative (-) charge could be delivered by a multitude of objects – such as friction – and this could cause accidental detonation. Therefore it should be wrapped with duct tape.

If you are assembling the bomb far away from the target, hook a small wire in the timer and around the metal rod to stop it from turning. When you reach the target, simply remove the wire and the timer will continue ticking.

When placing the timer with the IED at the place of destination:

- a. Connect the detonator to the receiver (in place of the lamp).
- b. Turn the knob on the timer to the time needed.
- c. Connect the battery.
- d. Place the detonator in the IED, situate it at the place of target and walk away.
- e. When the time set on the timer is over, you are now ready to detonate the device using the remote.

If you need to disassemble the IED from its location follow these steps:

- a. Turn the metal rod on the timer in order to disconnect the circuit.
- b. Disconnect the battery and the detonator.

In case the lamp doesn't turn on or you do not get a reading on the multimeter, then keep the wires that are connected to the negative (-) of the battery connector and the negative (-) of the receiver as they are and then test every other wire on the receiver by connecting it to the other end of the lamp or the multimeter. If the connections are right, the multimeter should show a reading of the voltage when pressing the unlock button on the remote control. It also depends on the battery you are using; so if you are using a 9V battery the reading should be close to 9V. If you are concealing the bomb, make sure to have part of



the receiver's antenna sticking out.

In this experiment, the remote control was pressed was about 70 meters away from the bomb in an open area. The city is not an open area so be within sight.

Mail Bomb (Push Switch Igniter)

Push switch igniters can be used to make detonators for mail bombs. It will ignite once opened and then detonate the bomb. Mail bombs can be sent without much hassle, but are rather difficult and dangerous to make. Just ensure that the mail bomb can not be tracked back to you after it has been sent. Do not rely on the detonation destroying the evidence: the bomb could be intercepted or could fail to detonate. Leave no genetic evidence or fingerprints on the mail bombs you make.

Materials:

- Push switch.
- 9v battery.
- Wires.
- Decorative lamp/detonator (ignitor).
- Package.
- Wood.
- Glue.

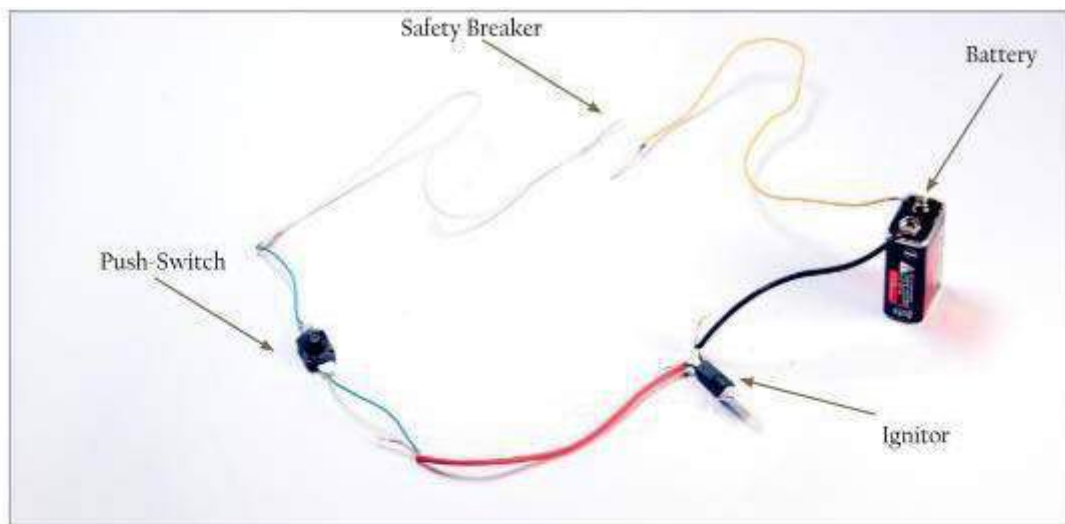

This is the main circuit, its main components are:
(1) - Battery. (2) - Ignitor. (3) - Push Switch. (4) - Safety Breaker.

If the safety breaks are connected and the push switch is not pushed down, electricity will run through the circuit and activate the detonator (ignitor). So, when the package is opened so that the push switch is no longer pushed, the detonator will activate and detonate the mail bomb. We will use a book and turn it into a package bomb, such that it will explode when opened. Below are the steps to follow in preparing the book.



Size of the book should be proportional to the size of the bomb placed inside.



Draw a boarder and start cutting the pages as shown above.



This book is ready for the bomb trap.



We will use pieces of wood to fix the switch button in the appropriate place.



Fix the push switch on the wooden piece using glue.

Fix the wooden piece in its suitable place in the book.

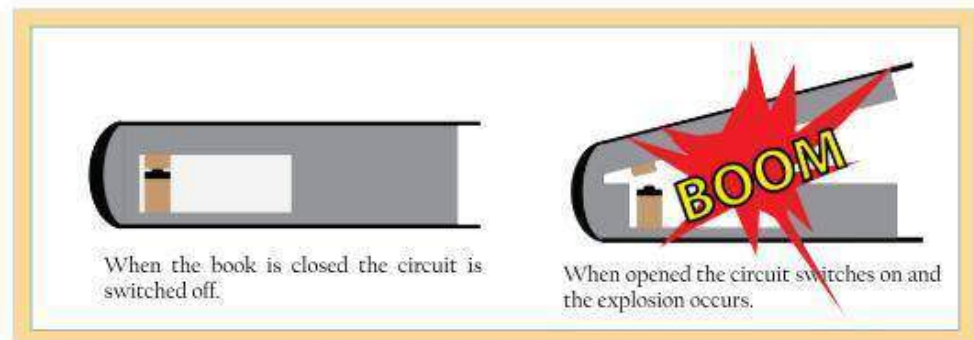

Place the bomb in the book and fix them properly. Place more shrapnel towards the side of the front of the book so that the detonation is even more devastating against the intended target.



We have to carefully remove these two wires from the back of the book as shown above without making a connection. You can wrap them up with sellotape, so as to avoid unnecessary contact. We remove the safety wires from the back of the back of the book. These wires when in contact will activate the electric circuit, and what is left is for the book to be opened and the explosion to occur. The importance of the safety wires is to prevent any accidents in case of any mistake i.e. if the circuit is connected then these wires will act as safety and prevent unnecessary explosions – so long as they do not come in contact!



To be sure that no mistake takes place, stay at a safe distance and separate yourself and the book using a thick wall. Extend a wire from each end of the safety wires (from the book). Place the book behind a wall and connect the wires together. Now hope for the

best, in that there have been no mistakes and the mail bomb does not detonate. If it does, the wall will protect you.

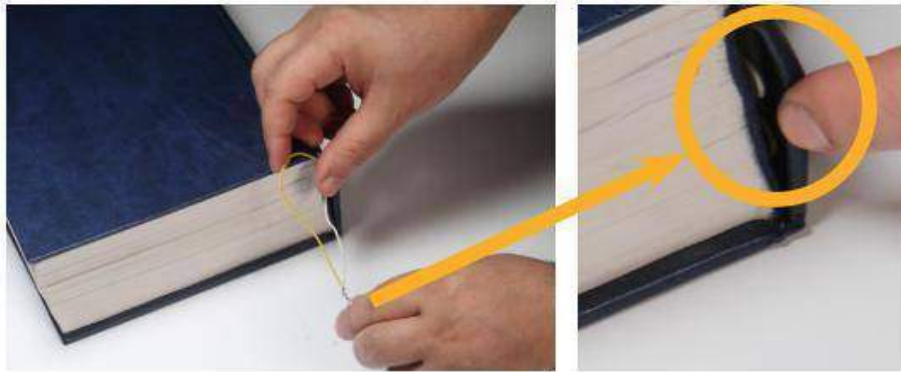

After being sure that the electric circuit is safe we can connect the safety wires and hide them inside the hardcover, on one of the ends of the book as shown above. You must experiment using a test lamp before actually connecting to the bomb, so as to confirm if the circuit is working. Cover the book so as to prevent any unnecessary opening of the book which will cause it to detonate prematurely.



Closed. Lamp is off.



Open. Lamp is alight.

Now cover the book in paper like a mail. This will prevent it from opening and detonating during transport.

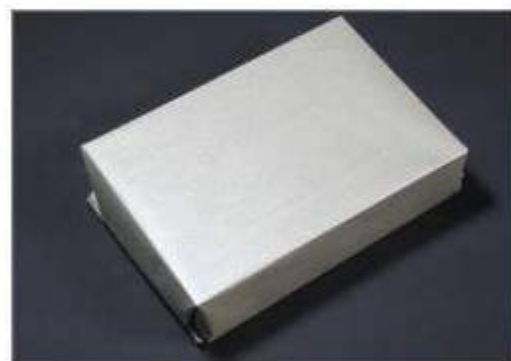

These are different types of packages you can choose from depending on the size of the bomb and the weight of the package. You would not want the book to be suspiciously heavy.



Magnet Bomb (Electric Wind Switch)

The electric wind switch ignites the detonator when exposed to wind such as when a car moves forwards. This comes most useful with magnet bombs. This is a small quantity explosive that can be carried by hand. When attached under a vehicle (such as a car), it will detonate when the car reaches a set amount of speed. This will either cause the explosion to kill the person in the car, or the person to lose control of the vehicle and be killed or injured in the crash.

1. Cut a rectangular piece of paperboard. (fig. 1).
2. Place a piece of carton on one end of the rectangular paperboard. (fig. 2).



Figure 1.



Figure 2.

3. Place an electric wire on the paperboard. (fig. 3).
4. Cut a piece of metal the same size as the paperboard.
5. Tie the metal piece to a wire.
6. Connect the wire to the toggle-switch. (fig. 4).



Figure 3.

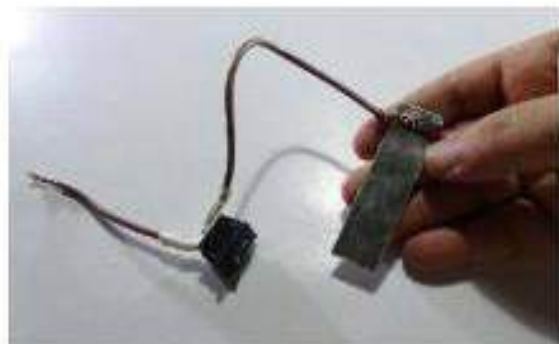
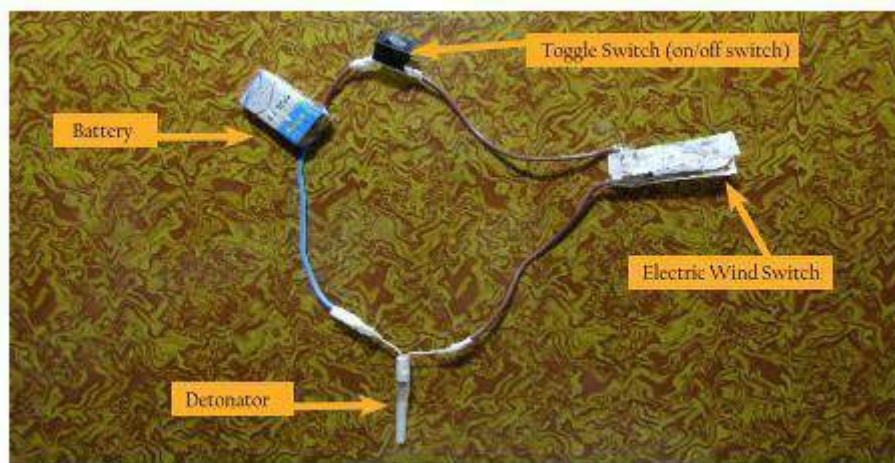

Figure 4.

7. Connect the paperboard to the metal piece in such that the carton acts as a separator between the two.
8. The switch is now ready, when the carton piece is connected to the metal the circuit will be connected. When the bomb is attached and this happens, it will detonate.



9. Connect the detonator, toggle switch, battery, and the electric wind switch.

Now to make a magnet bomb.

10. Connect the circuit to the bomb and fix the electric circuit to the advice. We place the electric wind switch in front of the bomb to face the direction of the wind when the car moves.
11. Take a strong magnet (such as one from a car antenna or electric speakers) and super glue it to a rectangular shape of metal. (fig. 5).



Figure 5.



12. Fix the magnet to the bomb, as shown above. And the bomb is ready for use. Place the explosives at an appropriate space under the car and turn on the toggle switch. As the car speeds up wind coming from the opposite direction will push the paperboard to make contact with the metal piece and thus connecting the circuit for detonation.

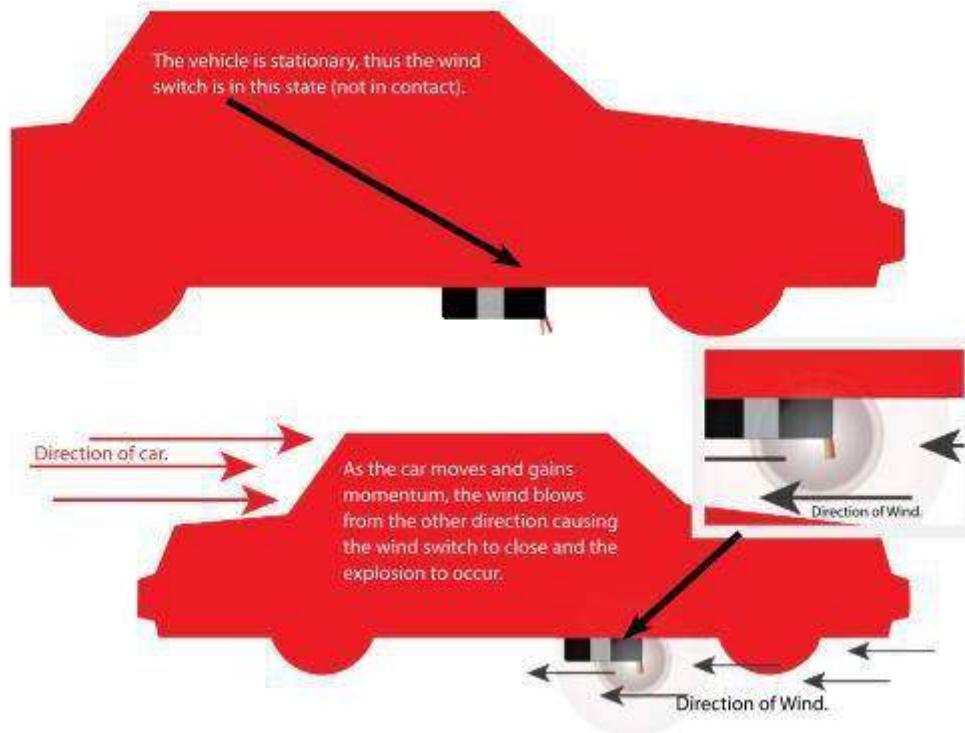

Grenade Ignition System

Of course, if the Army had fuses like this, then the grenade, which uses fuse ignition, would be very impracticable. If a grenade ignition system can be acquired, by all means, it is the most effective. But, since such things do not just float around, the next best thing is to prepare a fuse system which does not require the use of a match or lighter, but still retains its simplicity. One such method is described below (beware that this design will degrade over time and have to be replaced after around 2 weeks):

- Strike-on-cover type matches.
- Electrical tape or duct tape.
- Waterproof fuse.

1) To determine the burn rate of a particular type of fuse, simply measure a 6 inch or longer piece of fuse and ignite it. With a stopwatch, press the start button the at the instant when the fuse lights, and stop the watch when the fuse reaches its end. Divide the time of burn by the length of fuse, and you have the burn rate of the fuse, in seconds per inch. This will be shown below: Suppose an eight inch piece of fuse is burned, and its complete time of combustion is 20 seconds.

$$\frac{20 \text{ seconds}}{8 \text{ inches}} = 2.5 \text{ seconds per inch.}$$

8 inches

If a delay of 10 seconds was desired with this fuse, divide the desired time by the

number of seconds per inch:

$$\frac{10 \text{ seconds}}{2.5 \text{ seconds / inch}} = 4 \text{ inches}$$

2.5 seconds / inch

NOTE: THE LENGTH OF FUSE HERE MEANS LENGTH OF FUSE TO THE POWDER. SOME FUSE, AT LEAST AN INCH, SHOULD BE INSIDE THE DEVICE. ALWAYS ADD THIS EXTRA INCH, AND PUT THIS EXTRA INCH AN INCH INTO THE DEVICE!!!

2) After deciding how long a delay is desired before the explosive device is to go off, add about 1/2 an inch to the premeasured amount of fuse, and cut it off.

3) Carefully remove the cardboard matches from the paper match case. Do not pull off individual matches; keep all the matches attached to the cardboard base. Take one of the cardboard match sections, and leave the other one to make a second igniter.

4) Wrap the matches around the end of the fuse, with the heads of the matches touching the very end of the fuse. Tape them there securely, making sure not to put tape over the match heads. Make sure they are very secure by pulling on them at the base of the assembly. They should not be able to move.

5) Wrap the cover of the matches around the matches attached to the fuse, making sure that the striker paper is below the match heads and the striker faces the match heads. Tape the paper so that is fairly tight around the matches. Do not tape the cover of the striker to the fuse or to the matches. Leave enough of the match book to pull on for ignition.

6) The match book is wrapped around the matches, and is taped to itself. The matches are taped to the fuse. The striker will rub against the match heads when the match book is pulled.

7) When ready to use, simply pull on the match paper. It should pull the striking paper across the match heads with enough friction to light them. In turn, the burning match heads will light the fuse, since it adjacent to the burning match heads.

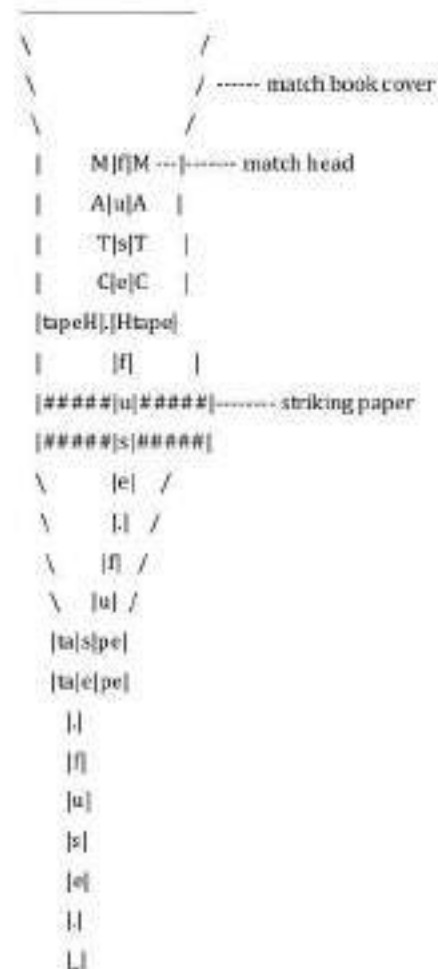

Electric Grenade Ignition System

Materials:

- 9v battery.
- Decorative lamp.
- Two wires.
- Toggle switch.
- Push switch.

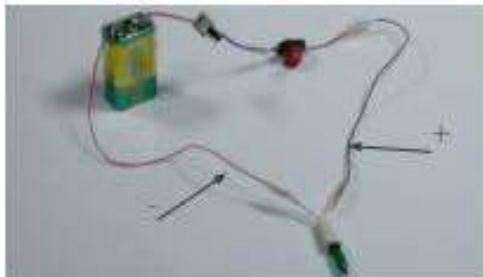
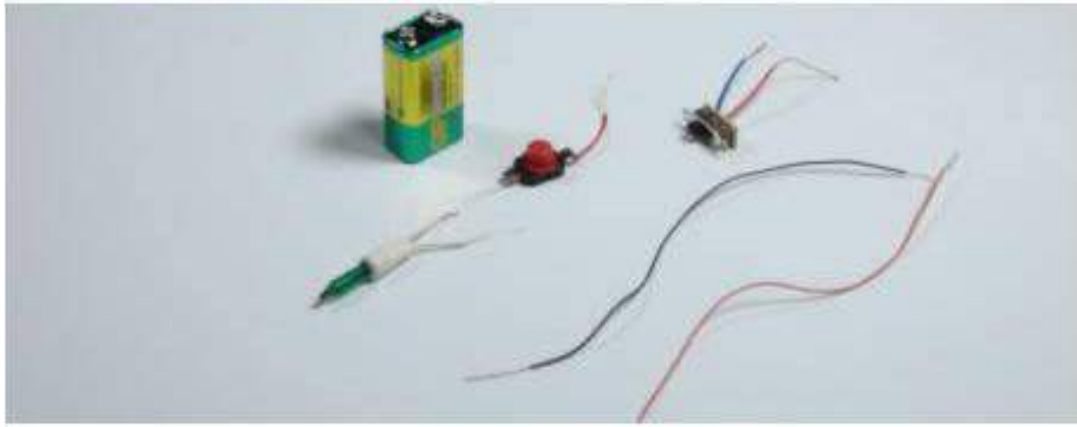

1. Connect the two switches using the same positive wire. Then connect the entire circuit.
2. We switch on the toggle switch.

When we press push switch, the circuit is connected. This is how the detonator will be ignited. Use a test lamp before using this igniter properly. The lamp will not be used as a detonator. The lamp does not even need to contain proper explosives. Phosphor will work. Put a fuse in the lamp so that it sticks out and tape it firmly so that it does not fall out. The fuse is ignited when the lamp is activated. It is important that the igniter and the fuse take the form of approximately 45° , so as to burn the tip of the igniter only and not the whole fuse all once. The fuse ends will be folded 90° to make this easier. Carefully connect the fuse to the detonator of the bomb and fasten the circuit on the bomb.



Press the push switch to ignite the fuse. The fuse should at least last 5 seconds. The system can be made safer by adding a cap over the push switch that can be removed by using two hands to prevent accidental pressing.

Pipe Bomb

The classic pipe bomb is the best known example of a metal-contained explosive. Idiots take white tipped matches and cut off the matchheads. They pound one end of a pipe closed with a hammer, pour in the whitetipped matches, and then pound the other end closed. This process often kills the fool, since when he pounds the pipe closed, he could very easily cause enough friction between the match heads to cause them to ignite and explode the unfinished bomb. By using pipe caps, the process is somewhat safer, and the less stupid terrorist would never use white tipped matches in a bomb. He would buy two pipe caps and threaded pipe (fig. 1). First, he would drill a hole in one pipe cap, and put a fuse in it so that it will not come out, and so powder will not escape during handling. The fuse would be at least 3/4 an inch long inside the bomb. He would then screw the cap with the fuse in it on tightly, possibly putting a drop of super glue on it to hold it tight. He would then pour his explosive powder in the bomb. To pack it tightly, he would take a large wad of tissue paper and, after filling the pipe to the very top, pack the powder down, by using the paper as a ramrod tip, and pushing it with a pencil or other wide ended object, until it would not move any further. Finally, he would screw the other pipe cap on, and glue it. The tissue paper would help prevent some of the powder from being caught in the threads of the pipe or pipe cap from being crushed and subject to friction, which might ignite the powder, causing an explosion during manufacture.

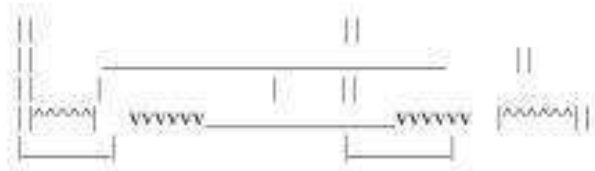

fig. 1. Threaded pipe and endcaps.

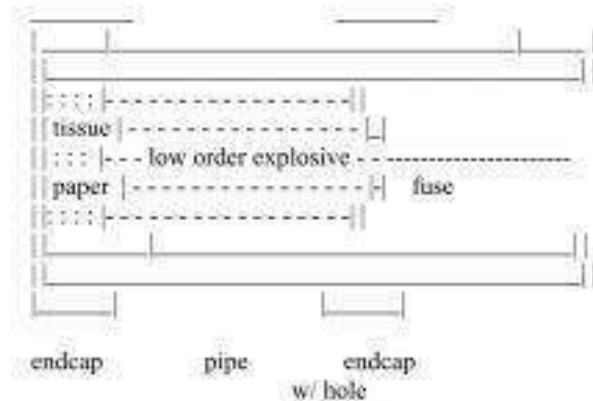

fig. 2 Assembled pipe bomb.

This is one possible design that a mad bomber would use. If, however, he did not have access to threaded pipe with endcaps, he could always use a piece of copper or aluminum pipe, since it is easily bent into a suitable position. A major problem with copper piping, however, is bending and folding it without tearing it; if too much force is used when folding and bending copper pipe, it will split along the fold. The safest method for making a pipe bomb out of copper or aluminum pipe is similar to the method with pipe and endcaps.

First, one flattens one end of a copper or aluminum pipe carefully, making sure not to tear or rip the piping. Then, the flat end of the pipe should be folded over at least once, if this does not rip the pipe. A fuse hole should be drilled in the pipe near the now closed end, and the fuse should be inserted. Next, the bomb-builder would fill the bomb with a low order explosive, and pack it with a large wad of tissue paper. He would then flatten and fold the other end of the pipe with a pair of pliers. If he was not too dumb, he would do this slowly, since the process of folding and bending metal gives off heat, which could set off the explosive. A diagram is presented to the right: A CO2 cartridge from a B.B gun is another excellent container for a low-order explosive. It has one minor disadvantage: it is time consuming to fill. But this can be rectified by widening the opening of the cartridge with a pointed tool. Then, all that would have to be done is to fill the CO2 cartridge with any low-order explosive, or any of the fast burning fuel- oxidizer mixtures, and insert a fuse.

A design employing a smaller low-order explosive device inside a larger device containing a high-order explosive would probably be used. It would look something like: if the large high explosive container is small, such as a CO2 cartridge, then a segment of a hollow radio antenna can be made into a low- order pipe bomb, which can be fitted with a fuse, and inserted into the CO2 cartridge.

fig. 1 pipe with one end flattened and fuse hole drilled (top view)

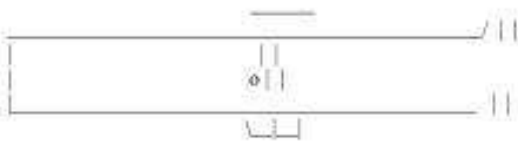

fig. 2 pipe with one end flattened and folded up (top view)

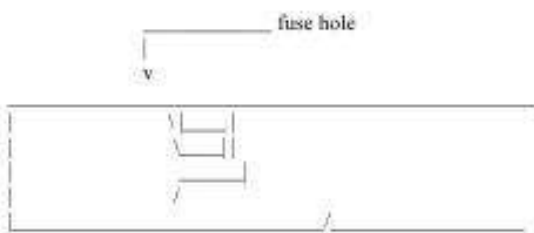

fig. 3 pipe with flattened and folded end (side view)

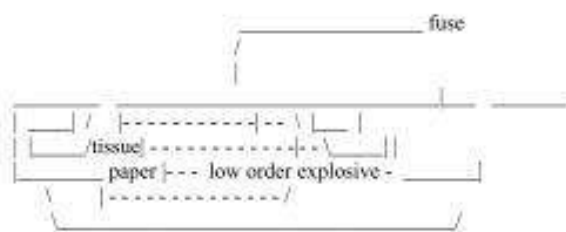
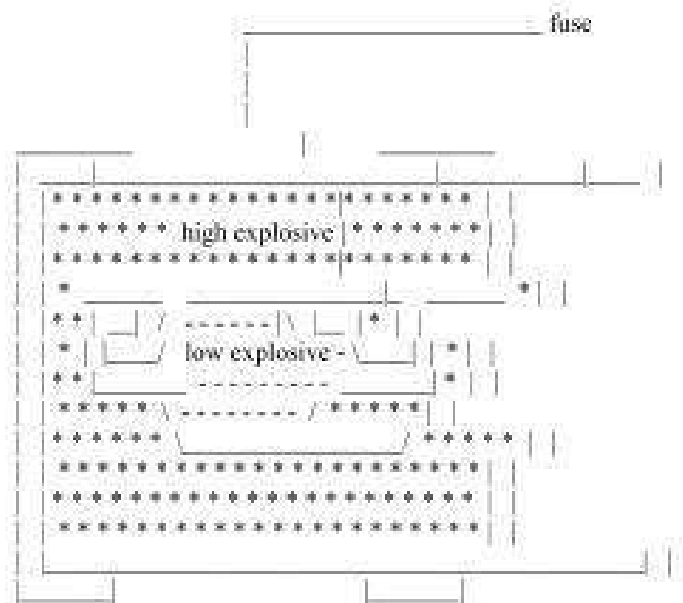

fig. 4 completed bomb, showing tissue paper packing and explosive (side view)



Car Bombs

Car bombs (which will also refer to truck and van bombs) are an effective tool to decimate a target of considerable size. They have been used to great effect both as suicide IEDs and remote detonations. There is no one size fits all approach to creating a car bomb. If you expect to encounter gunfire then you will have to consider adding considerable armor and adopting a driving style which suits the added weight and loss to maneuverability. The ideal car bombing mission involves remote detonation of a parked vehicle, as no guerrilla or terrorist will have to die.

When driving to your target follow all traffic laws. If using a fake delivery van, dress and act the part. The car should never be particularly suspicious. Parking an unclean red-brown van outside government headquarters and exiting out with guerrilla clothing will raise many more warning signals than parking a clean white van and exiting out dressed as a furniture mover or electrician.

Car bombs come in different sizes depending on the target. What will be needed is a tertiary bulk explosive, such as ANFO and ANNM. The bulk will make up most of the car bomb. A secondary booster explosive will be needed to detonate the bulk, and the more of the secondary there is, the better. The booster itself will have to be detonated with a detonator. Some spots outside the detonator place could have booster explosives which could be set off by the bulk explosives. Ensure that all the explosives are near each other to ensure complete detonation. Read the ammonium nitrate section for more information. The bomb should detonate when the building is crowded.

Put blinds or some sort of covers on the side windows except the rear window and the front side including windscreen. Inspect the car from all angles, can the bombs be easily seen? If so cover them with a blanket. Windowless vans are ideal for this reason. Ensure that the car bomb does not look too suspicious with covers on. Mostly gut the car internally for more space for bombs.

To avoid the car/truck flipping over while driving to the location yet still maintaining a powerful blast, the bombs will have to be organized into a shaped charge. While putting all barrels or crates containing the bombs right against the wall to the side of the target would be most powerful, doing so could cause the vehicle to break or flip to its side. A good shaped charge is the 'backwards J' which was used in the Oklahoma City bombing, shown below. The 'jaw' of the 'J' will face the target.

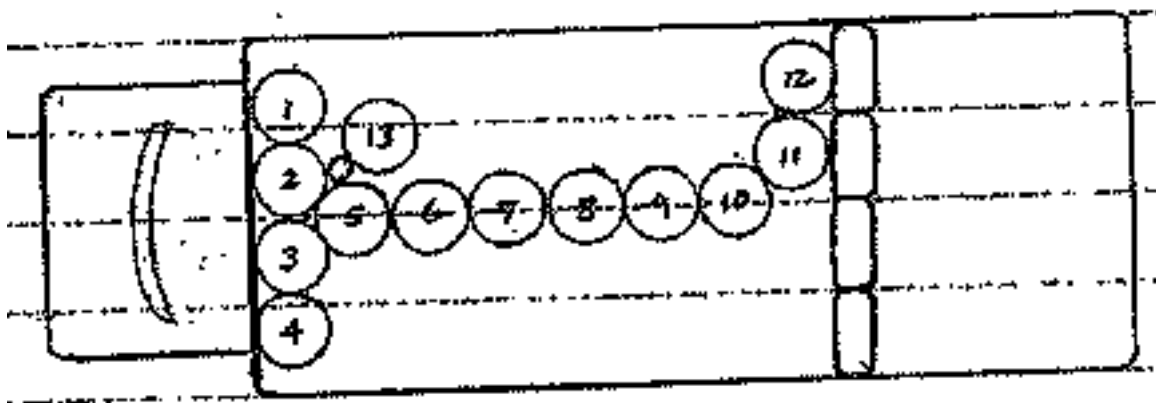

Sandbags could be placed behind the barrels to further direct the blast towards the target. Jugs of flammable liquids such as napalm could be placed over the barrels to cover the entire area in fire after the detonation. Propane tanks could also be placed near the bomb to engulf the remaining insides of the building in flames. Remember to fasten the barrels to the floor of the vehicle! Otherwise, the barrels could move about and make a less preferable shape when driving to the target location.

A car could be stolen or bought with cash and no papers signed to leave behind as little evidence as possible. Map out where security cameras are in the route that is to be taken to the target location – it is not important if the security cameras record the car nearby the target location. It is advised to put pillows or other soft things under the clothes worn to look fatter and to color ones visible skin during the operation. This way, when those things are taken off, it will be harder to identify the perpetrator. Do not park the car somewhere where it will be visible and connected to you during the preparation for the car bombing.

For every building there is a center of gravity and there are certain points in the building that if destroyed would cause the fall of the building. These points tend to be pillars and corners. If two corners of a building are struck, the building will hopefully come tumbling down. If one corner is struck in the bottom of the building the building may also fall down. The focus should be on the bottom of the building to take advantage of the weight of the building on top of it. The car bomb could also be detonated nearby a fuel tanker to increase damage.

Examples

Here will be provided multiple examples of powerful car bombs through history – from 1927 to 2017. You will be able to see first hand the destruction these bombs caused so as to base the amount of explosives your operation should use. The explosives used, the amount of explosives, the date, and the amount dead and injured from the explosives will also be noted beneath the image used.



1927. Bath Township, Michigan. 44 dead, 58 injured. ~250 kg dynamite and pyrotol.



2011. Oslo, Norway. 8 dead, 209 injured. 950 kg ANFO (derived from CAN and diesel and possibly some nitromethane and aluminum).



1987. Zaragosa, Spain. 11 dead, 88 injured. 250 kg ammonal.



1994. Buenos Aires, Argentina. 86 killed, 300 injured. 275 kg ANFO.



1993. New York City, New York. 6 killed, 1,042 injured. 606 kg urea nitrate.
(Underground of WTC heavily damaged; building intact).



2017. Mogadishu, Somalia. 585 killed, 316 injured. ~2,000 kg unknown explosive + nearby fuel tanker.



1995. Oklahoma City, Oklahoma. 168 killed, 680 injured. 3,200 kg ANNM.



2008. Islamabad, Pakistan. 54 killed, 266 injured. 600 kg TNT and RDX.



1993. London, England. 1 killed, 44 injured (warned beforehand). 1,200 kg ANFO.



1998. Nairobi, Kenya. 213 killed, 4,000 injured. 900 kg ANFO.

As you can see, a lot has to do with what building is targeted instead of what explosives and the amount of that explosive is used. The bombing in Oslo used a much more powerful bomb than in Buenos Aires, yet killed many less people. Simply put: the target building in Oslo was much more powerful at withstanding a blast. A lot also has to do with timing. Ensure that the car bomb detonates when the building is crowded with the intended target. When the building is destroyed, almost everyone in those parts of the buildings will be killed.

Note: It should be known by the user of the car bombs that all evidence will not be destroyed in the explosion. Timothy McVeigh, the perpetrator of the Oklahoma City bombing, was identified as the perpetrator after the axle of the truck he used was retrieved from the explosion. It was strong enough to withstand the explosion. If time is important for fleeing, you could place canisters of chlorine in the bomb. This way, the area will be poisoned after detonation. This is unlikely to kill anyone, but would make any police or medics sick when arriving to the target location, saving time for the terrorist to be unidentified.

Hardness of materials

The softest material one will likely encounter in buildings is wood, which is easily demolished and set aflame. Other weak materials are plastic, plaster, glass, and synthetic foam. More powerful than that are bricks, asphalt, and adobe. Most blasts should be able to destroy all of the materials mentioned. The more problematic materials are steel,

concrete, and stone. While steel is often set out as a 'skeleton', concrete and stone lay as solid blocks, which means that they will be more difficult to destroy. These materials are differently powerful when it comes to their uses and origin. Marble and sandstone are much more soft than gneiss and granite. Concrete is manufactured with different compressions for different uses.

The strength of concrete is measured in terms of pounds per square inch (or PSI). PSI is a measure of compressive strength, or the ability of the material to carry loads and handle compression.

2500-3000 PSI: Most concrete has a PSI rating of 2500 to 3000. This type of concrete can be used for sidewalks and residential driveways. This concrete is generally more affordable than higher strength concrete.

3500-4000 PSI: Concrete with a PSI of 3500 to 4000 is typically used for concrete beams and footings. It can also be used for slab foundations and high traffic roads.

4000-5000 PSI: Concrete with a PSI of 4000 to 5000 is found in warehouses and factories, in addition to other large-scale commercial and industrial properties.

6000+ PSI: Concrete with a PSI rating of 6000 or more is considered high-strength concrete. It is typically found in nuclear power plants and other areas where radiation contamination is possible. High strength concrete has a lower water-cement ratio, giving it additional durability and strength.

CHAPTER IX: AMMUNITION

Ammunition will be needed for firearms, and firearms are a must for any successful violent uprising. That ammunition will not always be available in its optimal form. Then, it will have to be produced. Homemade ammunition is very much to be avoided, but sometimes, times can be so desperate it must be used. It has been successfully been used by revolutionaries such for the 9mm cartridge in the wars in the Levant in the 1940s.

Cartridge size differs from weapon to weapon not only in the caliber (i.e. diameter) of the bullet, but also the overall length of the case. (e.g. 5.56.x45mm denotes a round of caliber 5.56 mm with a case length of 45 mm). Longer cases contain more powder, which can give more energy thus higher velocities.

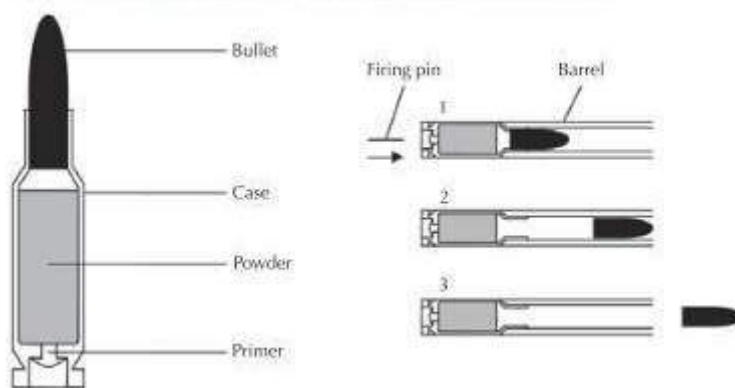

The anatomy of a round.

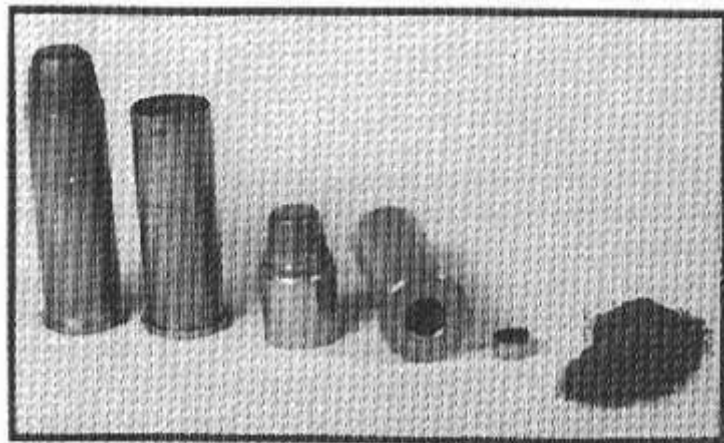

Components of a rifle cartridge. From left to right: the final, assembled cartridge, the brass shell casing, the lead bullet (in this case, a half-jacketed bullet), an empty shell on its side showing the primer pocket, a primer, and a small pile of gunpowder.

The topic of calibers is confusing. You might think that the bigger the caliber, the more powerful the gun. That is not necessarily so. Although caliber does denote the bullet,

diameter, you can have a small bullet backed up by a large powder charge or a large bullet backed up by a relatively small charge.

When storing ammunition, please take the following 2 factors into consideration:

1. To ensure that your ammunition will function properly, always store your cartridges in a cool, dry place that is free from extremely high temperatures.
2. Never submerge your cartridges in water or expose them to ammonia, bore cleaner, acids, salts, or petroleum products (including gun oil)—all solvents that can deteriorate the primer or powder in your cartridge.
3. For safety reasons, store ammunition so that it is inaccessible to unauthorized persons, especially children.

Straight-sided shells with rims will work the easiest in homemade firearms. Below is a listing of straight sided rimmed shells.

Caliber	Bullet Diameter	Shell OD	Rim OD
Rifle Ammunition			
.22 Rimfire	.224	.224	.272
.375 Win	.375	.418-.400*	.506
.444 Marlin	.429	.470-.453*	.514
45-70 Govt	.458	.505-.480*	.608
Handgun Ammunition			
.38 Super	.355	.380	.406
.38 S&W	.357	.380	.440
.38 Special	.358	.379	.440
.357 Magnum	.358	.379	.440
.41 Magnum	.410	.434	.488
.44 Special	.433	.456	.514
.44 Magnum	.433	.456	.514
.45 Auto Rim	.454	.476-.472*	.516
.45 Colt	.454	.480	.512
Shotgun Ammunition			
12 Gauge	N/A	.812	.875
16 Gauge	N/A	.750	.812
20 Gauge	N/A	.703	.766
.410 Bore	N/A	.478	.531

*Indicates taper.

Based on the above charts, a .22 rimfire cartridge would fit in 1/8" schedule 40 pipe. In fact, as the diameters are the same, .22 short, .22 long, .22 long rifle, and .22 Magnum could all be fired in a gun made from such pipe.

Note that a larger number of "gauge" in shotgun ammunition makes the shell smaller.

Reusing Ammunition

Since the guerrilla does not have lots of ammunition, the ejected cartridges are best saved for reuse. It will have to be filled with propellant and primed with new primary explosives. However, the primer cup has dented, since it has been struck. With a blunted spike and a hammer, strike the insides of the primer cup until the dents are gone. Now, the entire cartridge will be prepared for becoming usable ammunition for the guerrilla once again.

IMPROVISED AMMUNITION

Note: Special thanks to Anders Behring Breivik, Uncle Fester, P. A. Luty and Rich Stern.

Bullets

The bullet casting process can be easy, enjoyable, and in many ways, relaxing. It's also liberating. Have you ever had your eye on an unusual gun, but were put off by the oddball caliber and lack or expense of commercial ammo? No problem! When you realize you can easily and inexpensively make bullets for anything that shoots lead, you'll be buying that old warhorse in a heartbeat.

We'll be dealing with molten lead alloy, as well as some other obnoxious substances (more on that in a moment). You must take care to avoid toxic fumes as well as minimize burn hazards. I do all my melting and casting outside, under a covered porch, with plenty of ventilation. I have a set of inexpensive tools dedicated to this process, and they get used for nothing else. If you have young ones around, you need to be even more cautious, because lead ingested by kids can cause harm to their developing bodies. Keep youngsters away from the casting process until they are old enough to participate responsibly. When done casting, clean up your work area so that nothing is left behind for them to get into trouble with.

Our society has demonized lead in the last thirty years. The government would have you believe you'll fall over dead at the very sight of lead. It's not as bad as that, but common sense is required. Wash your hands frequently, and always before you are about to eat or drink after handling lead. Avoid touching your eyes, nose and mouth while handling this stuff. If your clothes get contaminated during the casting process, change them before resuming your normal family and work routines.

Minimal safety gear:

- A work area with good ventilation; outside would be best.
- Safety glasses (eyeglasses or range safety glasses will work).
- A pair of heavy work gloves.
- A sturdy surface to hold your burner and lead pot.
- Closed top shoes.

Optional, but a good idea for some folks:

- Long sleeve pants and shirt.
- Respirator mask.

Lead can be purchased from scrap yards, plumbing supply houses, and mail order companies that sell reloading supplies. However, the easiest source of lead for basic casting is used wheel weights, available by the bucketfull at any tire shop or auto dealership. Bring your own bucket, stop at the service manager's desk, and politely ask if they'd be willing to part with some used wheel weights. More often than not, they will gladly give you as much as you can carry. Some places may say no because of liability concerns or because someone pays them for the scrap metal. I've visited four tire shops in my area, all were happy to let me take as much as I felt like carrying.

Wheel weights are ideal for casting basic bullets. They contain a small amount of tin (about 0.5%), as well as antimony (about 5%). The tin makes the molten alloy flow better, and the antimony makes the alloy harder. Bullets made of wheel weights typically come out just right for moderate handgun velocities, and work well at modest rifle velocities if you add a gas check to the bullet. Casting experts have developed expertise in varying the alloys for different purposes. Specific amounts of tin and antimony can be added to create very different working properties for cast bullets, for specific uses.

The list of equipment is minimal, and actually rather primitive by the standards of our modern, digital age. After all, this process is hundreds of years old, and the equipment of yesteryear (a campfire, an iron pot, a ladle, etc.) still works.

You can buy equipment specific to bullet casting. Or you can go the economy route, as I did. The cookware section at the local Walmart provided most of my gear. Here's my list and what each item cost. As you can see, there isn't much investment to get started:

- Electric, single burner stove with variable temp control, \$9.
- 1 quart aluminum saucepan, \$3
- Stainless steel condiment cups (used for molding ingots).
- 2 packs of 4 cups, \$1/pack.
- 10x10 aluminum cake pan, \$3.
- 3 pack, 10x10 aluminum foil cake pan (disposable kind), \$3
- Metal spoons, six for \$1.
- Small ladle for scooping and pouring molten alloy (I use a Lee ladle from MidwayUSA).
- \$3 Fluxing material: Used candlewax, old crayons, bullet lube, pretty much anything that is wax-based will work.
- A bullet mold (more discussion on mold section a bit later). From \$16 to \$60, depending on type. Can be improvised (see the mold section).

We'll start out by making ingots. While not absolutely necessary, it's a good way to clean your wheel weights, and get some practice pouring the alloy before we start casting bullets.

It is critical that you have good working space. Outside and covered is ideal. We need to avoid the fumes, and we also need to avoid having any water near our melting pot. You must make sure that no moisture comes in contact with the molten alloy. A drop of water in the molten lead can cause a steam explosion, splattering molten lead all over you and anything else nearby. Water and molten metal do not mix!

For basic casting, use only the wheel weights that have the steel clips. The stick-on, adhesive backed wheel weights are pure lead; too soft for modern bullets. Save them for

another day if you shoot black powder and want to cast your own muzzle loader balls, or you want to custom mix alloys by adding other casting metals.

Put about 5 or 6 pounds of wheel weights in the pot and turn the electric burner on full power. Go find something to do for 20 to 30 minutes. Come back every five minutes to check the pot, but don't hang around too long. The crud on the wheel weights (road grime, tar, dog piss, etc.) will start to burn off, and the smoke is about as foul as anything you'll ever smell.

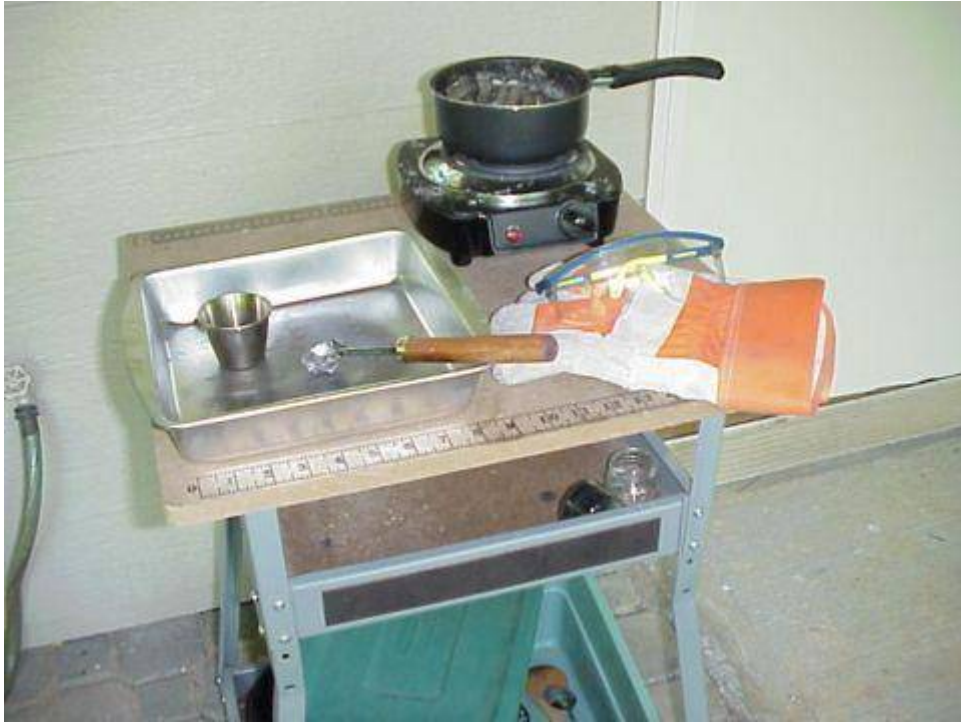

My basic setup.



Melting down wheel weights... odors reminiscent of the New Jersey Turnpike.

The 1100 watt Walmart electric burner needs to be left on high to keep 5 to 8 pounds of wheel weight alloy in liquid form. I just set it there and leave it. It's just hot enough for efficient pouring. For more advanced casting with harder alloys like Linotype (printer's lead), a stronger heat source is needed.

Once the alloy is molten, the steel clips and a whole lot of other crud will be floating on top of the mix. Skim it off with a spoon. Dump the skim into one of the baking pans. Remember, all this stuff is very hot, so handle it with care. Don't put it in the trash until it has cooled off. Once you've taken the debris off the top, you are left with a dirty soup of liquid metal, somewhat silvery in color, but with some black, ash-like stuff floating around. Those are impurities we will take out with flux.

Once the alloy is molten, the steel clips and a whole lot of other crud will be floating on top of the mix. Skim it off with a spoon. Dump the skim into one of the baking pans. Remember, all this stuff is very hot, so handle it with care. Don't put it in the trash until it has cooled off. Once you've taken the debris off the top, you are left with a dirty soup of liquid metal, somewhat silvery in color, but with some black, ash-like stuff floating around. Those are impurities we will take out with flux.

Fluxing! Sounds far more complicated than it is. Simply put, we're dropping some wax (or bullet lube, or fluxing compound) into the mix. Its role is simple: Make anything that is not lead alloy stick to the flux material so we can easily scoop it out. Take a few wax shavings, drop them in. It will smoke, and may even burn. Wait until the smoking stops, then slowly, but thoroughly, stir the mix with your spoon or ladel, scraping the sides and bottom of the pot. All of the gray, black, flakey crap that forms at the top, we want to try and corral and skim off. You should be left with nice, silvery looking molten alloy when you've finished fluxing. Don't drive yourself nuts seeking perfection on this step. There will always be some crud left on top of the mix. But it should be minimal. More will show up later, and you can flux again anytime you feel it is worth getting more crap out of the mix. Small amounts of impurities won't hurt the mix, but we don't want chunks of garbage in there, either.



Clean alloy, ready for casting into ingots or bullets.

With nice, clean wheel weight alloy in liquid form in the pot, it's time to pour some ingots. Take the stainless steel condiment cups and place in one of the cake pans, on a level, sturdy surface. Make sure that whatever surface you use will stand up to the heat. The alloy is somewhere between 625 and 700 degrees, and will apply considerable heat through the cups to whatever they are resting on.

With your gloves on, pick up the pot and pour the molten alloy into the cups, until they are about 2/3 full. Pour carefully to avoid spills and splashes. Let the cups sit undisturbed for about two minutes, so the alloy can harden. After that, you can pick up the pan and move it if you are concerned about where it is resting. I usually put it on the ground (concrete) after the lead has returned to solid form. The ground helps dissipate the heat more quickly.



Ingots in their "molds" after pouring and solidifying, moved to the ground and left to cool.

You can buy a fancy ingot mold for \$10 to \$20 so your ingots say "Lyman" or "Lee" but I'm not terribly interested in having someone else's name on something I made. After about ten minutes of cooling, with your gloves still on, turn the cups over and gently tap them. The ingots fall right out. They will still be hot, and so will the cups, so be careful handling them. After about 20 minutes, they are cool enough to handle. Here's what you get:



Filling the condiment cups about 2/3rds full results in convenient, 1 pound ingots.

Now we have nice, clean, nearly pure lead/tin/antimony alloy ingots that are perfect for casting bullets, in a handy size, easy to store, and easy to melt. A pound of nicely cast wheel weights goes for about a buck on eBay, so if you really want to go to town, you can sell your excess ingots for a little cash. We're ready to cast bullets.

You'll need one or more bullet molds, based on the caliber, weight and style of bullets you like. Bullet molds are available from many online sources like MidwayUSA, Brownells, Midsouth, etc. Used molds can be found on eBay. There are two major types of molds: Aluminum and iron. I have several Lyman iron molds, and they work very well. I also have some Lee molds that took me a while to get the hang of; once I mastered using them, I started to produce some nice clean bullets. Aluminum and iron have different casting properties and dictate slightly different approaches to casting, and involve a small learning curve. The molds commonly come in single, double, quad and six bullet configurations, which impacts how quickly you can cast bullets. Some of the bullets will be improperly formed rejects. They just go back into the pot for another try. The molds have to heat up to produce good bullets, so it may take some practice casts until you get good bullets.

Lee molds are inexpensive, typically less than \$20 for a two cavity mold, and should last for 10s of thousands of bullets. The iron molds, properly cared for, can be passed to your grandchildren. Unless you abuse them, they don't wear out. Lyman sells rebuild kits that contain washers and screws, for replacing the parts that most likely will wear out before the mold.

Each mold needs a handle (some molds come with handles, others require they be purchased separately). The sprue plate is a hinged plate with a hole for each mold cavity, through which the molten alloy is poured. When the alloy has solidified, the sprue plate is opened, which cuts the excess lead from the base of the bullet. The mold is then opened and the bullets should fall out, or fall out with a gentle tap from a block of wood. It's best to have a piece of cotton cloth for the bullets to land on, or the aluminum foil bake pans can be used. The bullets are just below molten temperature when they come from the mold, so they are soft and can be dented easily. Some casters drop them into a bucket of water (with all of the safety caveats that come with such a practice...remember what I said about water near the melting pot). This is called quenching, and produces a considerably harder bullet than just air cooled bullets. Most shooters will be well served with air-cooled cast bullets, but if you want harder bullets, quenching is an easy way to get them using wheel weights.

The process isn't much different than the ingots we just poured. Follow the mold manufacturer's directions for mold prep, which may involve lubricating parts of the mold, and smoking the mold with the smoke from a lighter or matches.

When your lead alloy is molten, scoop some into your ladel and pour it into the mold until a puddle forms on top of the sprue hole. Wait until it hardens, about 3 to 5 seconds, then open the sprue plate and drop the bullets out. Sometimes a tap from a wooden dowel is needed to free the sprue plate or get the bullets to drop out of the mold. With some experience, you'll learn how to efficiently do all of these steps. Close the mold, pour more alloy in, and keep it up until you have the quantity you want. Keep an eye out for poorly formed bullets, which could indicate problems with alloy or mold temperature, or foreign debris in the mold. The mold has to heat up to a good working temperature before you get consistent results, so your initial casts may produce quite a few rejects. You can put those

back into the pot. Be careful not to splash molten alloy on yourself or your work area. A few minutes on prep will minimize the number of rejects.



Some of my cast bullets: .314 rifle bullets on the right, and .357 wadcutters for my .38 special.

After casting, one or two operations remain. We may have to size the bullets. This depends on a couple of things: The size of your gun's bore, and the size of the bullet the mold casts. If you can fit a bullet into a case without bulging the case, it does not need to be sized. For example, the .314 caliber wheel weight bullets from my Lyman 311495 mold fit into a flared .303 British case. My Enfield's bore size is .312. A cast bullet that is .001" to .002" greater diameter than the bore is good. If the bullet is undersized, the bullet may not fully engage the rifling, resulting in poor accuracy. If the bore is too small, the bullet may generate excess pressure and leave lead in the barrel. Lee makes inexpensive sizing dies that cost about \$12/caliber and work with any reloading press that takes standard dies. Lyman, RCBS and others make more sophisticated, one step lubricating/sizing tools, and these are often preferred by casters who want the finest. The Lee dies work. The sizing step is also good time to put gas checks on bullets intended for high velocity loads. A gas check is a small metal cup that fits around the end of the bullet. It is typically press fit at the same time the bullet is pushed through the sizer die. The gas check protects the bullet from the high pressure and heat of the powder burn, and reduces or eliminates barrel leading that would otherwise occur at high velocities.

Lee sizing dies come with a liquid bullet lube that is easy to apply. You put the bullets in a plastic tub, add the lubricant, and tumble the bullets around until they are coated. You then set them out on wax paper overnight to dry. Cast bullets must be lubricated, or they will leave lead in the barrel of your gun, making cleaning a real bear.

That's basically it. Advanced bullet casting is simply additional detail or processes on top of what I've described. Using the above info, you can experiment and custom match bullets to your guns for excellent accuracy.

Bullet molds

Regarding the bullet mold: you can make your own bullet mold by welding two half molds to a pair of garden scissors (make sure it closes flush to one another). To make a half mold, design a valid bullet shape. Now sand, mill or lathe one end of a bar of steel until it is exactly the shape of the bullet you want to make. This will require great precision, so allow yourself time and measure frequently. Next heat up a block of steel with a blowtorch until it is white hot (just before it melts). Press the cold steel form into the hottest area until it is exactly half the way in. Use a wooden block at the exact height of one half bullet below the edge of the heated block to hold the rest of the bar, this will aid in getting exactly half. Immediately remove the steel bar and allow the steel block to cool. Measure the indentation. If you pressed too deep or shallow then try again elsewhere on the mold until successful. Melt down the entire block into a new ingot if you repeatedly fail. Repeat the process for the other half mold. Remember: the tolerances for the bullet are very precise, if you need a perfect mold then try pressing the bar vertically into the heated area and cutting the entire block in half in the middle of the bullet casting hole. Another method is making a clay bullet and pouring the ingot around it. Remove the hardened clay with a chisel after cooling.

Poison Bullets

Buy hollow point bullets (JHP) and use a syringe to inject the toxin. Plug the hole when done. If necessary, use the thinnest of drill heads to make the hollow area bigger before injection and plugging.

For this you will need a rifle/pistol hollow point bullet. Hollow point ammo is impossible to acquire for pistols in most countries and hard to acquire for semi-automatic rifles in some. If acquiring hollow point ammo is not an option for you, you have two options:

1. I haven't actually bothered to test the following method, since I have access to hollow point ammo for my Ruger Mini-14. But theoretically, this should work: set up an improvised work bench, fasten the projectile (I don't think it will work if the projectile is still inside the bullet) and drill out a hollow chamber in each projectile from the top down (you first cut off the tip with a metal clipper). It may be easier to use FMJ (full metal jacket) bullets as it consists of a lead projectile with a metal layer. When you clip the edge it should be easy to drill out enough lead to form an appropriate hollow chamber which can be plugged. This will require some practice and expect to fail on your first few projectiles. As soon as you have successfully drilled out a hollow chamber inside the desired number of projectiles you must self load these projectiles to produce bullets. As soon as you have created the bullets only the injection and plugging remains. Choose an injection method based on the toxins substance form. For liquids use a syringe with needle, for powder use a mini funnel. As you have injected the desired amount of toxin (60-150 mg) you seal the chamber by placing a small circle of aluminum foil (created by using a paper hole puncher. You put the circle in place with a pincer and place a drop or two of superglue to seal the chamber. You then place another circle of aluminum foil above the layer of superglue followed by a drop or two of melted tin to complete the job. Alternatively, you may create plastic/rubber

improvised plugs and for example add a little bit of super glue. You end up with a chemical/biological projectile with a relatively a smooth projectile tip.

2. Bullet casting: order a hollow point custom mold from a US/Euro company and cast your own projectiles.

Abbreviations:

- Jacketed Hollow Point = JHP (common).
- Jacketed Hollow Core=JHC (rare).
- Hollow-Cavity Bullet=HCB (rare).
- Cavity Bullet=CB (rare).
- Full Metal Jacket=FMJ (common).

Equipment required:

1 x Electric furnace (Lee precision furnace).

2 x bullet mold.

Long steel spoon with wooden handle (to gather impurities in the fluxing process).

1 x ledle (furnace spoon for molten lead).

20 x bullet lead bars (melted in the furnace).

1 x piece of wood to tap open the mold.

1 x full face respirator with toxic vapor filters (for example 3M 6800), since lead is a toxic substance and will cause fumes to form. The safety glasses component of your full face respirator will prevent any lead splatter in case water accidentally touches molten lead.

1. Fluxing: You need to make sure your lead is clean before you cast it into the mold. Thus, you need to start with a simple lead purification process which is required to ensure lead purity after you melt your bullet lead bars.

- Take a bullet lead bar and melt it in your electric furnace.
- Take a small spoon size of fluxing compound and put it in the molten lead. I do not know the exact ratio; probably 5 g per lead bar, although this is probably indicated on the box.
- Stir the molten lead until the fluxing compound (for example: a box of Frankford Arsenal – CleanCast Lead Fluxing Compound) is completely dissolved and impurities start to gather on the surface.
- Spoon out the impurities until the surface is completely “silvery”
- Your lead is now purified and you can start on the actual molding process.

2.

- Have your mold and your ledle warmed up.
- Fill the mold with lead, wait 10-20 sec, then hit the mold with a tree stick over a bucket filled with water (at least 2 meters away from furnace). The lead projectiles will come out of the mold and be cooled in the bucket of water. This will instantly harden the lead projectile so you avoid any lead particles in the barrel. Avoid getting any water close to the molten lead as it will cause a reaction which will lead the lead to splash (steam explosion).

3. Preparing the bullet for reloading.

- You need to put the projectiles from the bucket of water into a sizer. It will size the bullet to the exact diameter of the bore

- You then have to treat the projectiles with a lubrication liquid. You may put 100 projectiles in for example a milk jug and mix it around in a liquid lubricant. Let sit overnight in the liquid lubricant. This will ensure that the projectiles are completely lubricated and will prevent lead from being shaved off the bullet as it goes down the bore of your weapon. Ignoring this aspect will result in the projectile leaving a considerable amount of lead particles in your barrel and make it an inaccurate bullet.

There will be some potential mistakes during bullet casting. Not all projectiles created will be usable. Estimate a 50% failure rate where the projectiles will be significantly flawed and have to be “redone”.

- Frosted bullets (rugged surface) is a result of the molten lead being too hot. Try to lower your temperature a bit.
- Impartial base on bullet: not enough lead poured in
- Large marks/voids in bullet: mold wasn't hot enough or molten lead being too hot, or mold wasn't filled in one motion
- Flawed lube bands, void in base or minor marks/voids on the side, top base: is caused by either having garbage/impurities in the mix, or whacking the sprue plate before it has cooled enough. If the lead is still very hot, the sprue plate will take some lead from the base with it.

You use a standard round for every chemical/biological round. A clip of 30 (28) bullets would contain 15 (14) poison rounds and 15 (14) standard rounds. You budget 2 bullets per targeted individual which will ensure at least one lethal chemical/biological hit per person. Hollow point bullets are superior for soft targets (targets lacking armour) as the projectile mushrooms immediately after penetration of the skin. This results in optimal tissue damage and prevents the projectile from exiting the body. As such, the chemical or biological toxin is dispersed in and around the wound.

You should always bring a couple of clips containing ammunition designed for defeating system protectors (with body armor). Hollow point ammo is worthless against such armor as it fails to penetrate the Kevlar. For defeating system protectors you must bring armor-piercing ammo, alternatively brass bullets or FMJ. However, an alternative strategy is to set up your “system protector clip” in such a way that every other bullet is chemical/biological. In an optimal setting you could be able to aim for the legs/arms/face every other shot. Because if the word is out that KT is using lethal chemical/biological rounds against system protectors again, it will contribute to sow terror into their hearts and will thus contribute to defection or as a deterring factor.

Armor Penetrating Bullets

Armor penetrating (AP) bullets are capable of breaking through body armor. What will happen is that once the AP rifle bullet hits the target it will break but the penetrator will continue going forwards. Do not make the bullet entirely out of the penetrator material. Doing so will damage the barrel. It is very important that the finished AP round is full metal jacketed.

There are different ratings for body armor and this will have to be accounted for. It should be obvious to the reader that a variety of factors determine how effective a given round will

be when it encounters body armor. Foremost among these factors is the amount of “wallop” or kinetic energy the bullet carries with it when it encounters the armor barrier.

$$KE = \frac{1}{2}mV^2$$

From this follows the fact that most handguns are ineffective against commonly encountered armor. The small load of powder in the cartridge, and the short length of travel down the barrel that the burning powder has to accelerate the bullet, results in a low projectile velocity. The velocity is by far the overriding consideration. When calculating the kinetic energy carried by the bullet, because, kinetic energy increases by the square of velocity, while it is only directly proportional to mass. Increasing the velocity of a bullet does much more to punch it through armor than increasing its weight.

So what else determines the performance of a bullet when it meets a vest. The answer to that is bullet construction. For illustration, study the .223 (5.56mm) round pictured to the right.

This round is still legal in the USA as of mid-96, because it is meant to be fired from a rifle. It also exemplifies good construction of a body armor-defeating round which is commercially available. Why is it so good? To answer that one must consider two other factors that will often make a given bullet useless against armor: flattenability and splinterability.

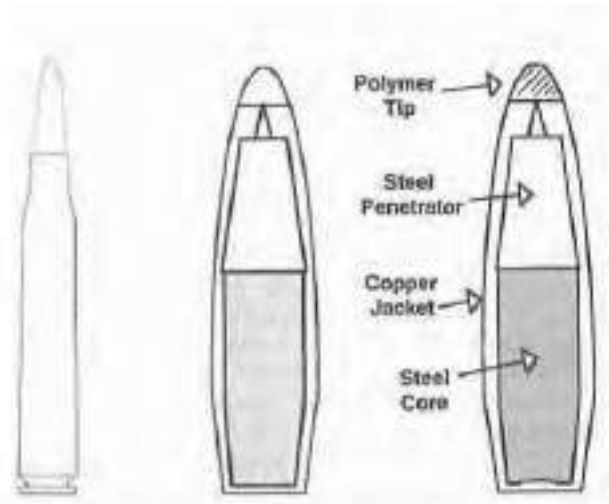

Many bullets are purposefully designed either to flatten out when they strike an object (called mushrooming) or to break apart into flying splinters. This design causes them to do a great deal more damage to body tissues than an intact bullet whizzing right straight through. It helps to ensure that the entire kinetic energy load of the bullet is transferred to the soft flesh it encounters. It also ensures that the bullet will perform poorly against Kevlar armor. The bullet pictured does not have this problem.

The next thing to note about this bullet is the steel core just behind the point of the bullet. Nearly all bullets have a core made of lead. Lead, being a very heavy metal, gives the bullet added weight. This added weight improves its flight characteristics, keeping the bullet on track through brush, leaves, twigs and crosswinds. It also gives added momentum to the round.

$$M = mV$$

Lead is also very soft. You can almost bite through a piece of lead. This softness causes easy flattening of the projectile when it strikes an object. The steel core behind the nose of the bullet helps the point maintain its shape.

Further, note the large charge of powder contained in the cartridge for propelling this projectile. The specification sheet for this bullet claims a muzzle velocity of 3,000 feet/sec,

carrying a kinetic energy of 1,240 ft-lbs. This bullet is capable of penetrating “type UT body armor as sold, right out of the box.

Penetrators

The discussion up to this point has mostly centered around commercially available bullets as the matrix upon which to apply Teflon-coating to improve their performance. One need not be so limited in choice. As was mentioned in passing earlier, a solid-steel bullet will greatly outperform its softer commercial cousins in use against Kevlar, not to mention other “bulletproof materials such as “bulletproof glass, metal plate, wood, cement, and so on.

If one possesses, or has access to, a metal lathe, turning out steel bullets is a very simple matter. Such lathes are widespread in the metal working industry. In the plating plant where I spend my days, the metal lathe could easily be put to use for such a purpose. I’m sure this condition is not unique.

To produce solid-steel ammunition, one need only load the lathe with steel rod of appropriate diameter (caliber) to be compatible with the gun from which it is intended to be fired. Then bullets can be cut from the rod which possess the sleek, streamlined shape so preferred for slicing through Kevlar armor. There are two main caveats to be heeded in the cutting of custom made bullets. First of all, the bullet must come out perfectly symmetrical in shape along the long axis of the bullet. The reason for this is pretty straight-forward. As a bullet accelerates down the barrel of a gun, the rifling inside the barrel imparts a spin to the bullet. This spin works to stabilize the bullet during flight, much as the spiral on the football keeps the football from wobbling around or going end-over-end to the receiver. Similarly, if the bullet is cut asymmetrically, the excess weight on one side will cause the bullet to tumble wildly in flight, thereby ruining accuracy and preventing the bullet from striking the target pointed nose first. On a good lathe, making a symmetrical cut is no great feat, as long as the steel rod is straight, and doesn’t wobble around as it is being cut. Higher quality steel rod produces a correspondingly more formidable projectile, but is also more difficult to cut. Alloy steels of the 4000 and 5000 series are a good compromise between the very easily cut, mild steel on one end of the spectrum, and the exceedingly hard tungsten steel on the other.

The other caveat to be kept in mind pertains to the diameter of the bullet as cut. To apply Teflon to this steel bullet, the steel must first be etched in acid to pit the surface of the metal. These pits form footholds for the Teflon to bond to the metal surface. Copper-jacketed bullets must similarly be etched. Then a layer of Teflon must be applied at least one mil in thickness to get that enhanced penetration effect. The cut must be done so that when the bullet is coated with the desired amount of Teflon, the correct bullet caliber is obtained. There is much more on this in the next section covering the procedures to follow to get a nicely Teflon-coated bullet.

The home or workshop manufacture of Teflon-coated bullets of very high quality is not a particularly hard, nor involved process. The process is, in a nutshell: degrease, etch, dip, and bake. All of the steps are just as accessible to someone working out of a garage or basement as they are to someone putting in their time on a factory floor.

The chemicals needed to prepare the metal for coating are found in any kitchen or hardware store. Degreasing, for instance, is pretty much identical to washing greasy dishes. Similarly, the all important etch step uses hydrochloric (muriatic) acid right off the hardware store shelf to etch steel projectiles. Copper-jacketed bullets are etched in a mixture of hydrochloric and ammonium nitrate fertilizer to generate in situ nitric acid to etch the copper. The dipping and baking steps are also just as simple as they sound.

The beneficial effect of Teflon coating isn't limited to metal targets. In fact, it's considerably more pronounced when penetrating fibrous substrates such as wood, phone books, walls, and Kevlar. This is just as one would expect based upon common sense.

Cleaning

Getting the dirt and grease off of the metal surface is the first step to getting an adherent coating of Teflon on the projectile. The removal of all traces of grease and dirt from the surface of the metal is required for two reasons. The first reason is that if a greasy film were left on the surface of the slug, this film would act to protect the surface of the metal from the acid etch used in the next step. This acid etch is very important to both shrink down the size of the commercial slug so that a coating can be applied to it, and to form a rough pitted surface for the coating to find footholds in. It is therefore vitally important that a surface free of all grease and dirt, including fingerprints, be achieved before moving on to the acid-etch step.

The second reason why all traces of grease and dirt must be removed from the surface of the metal is the obvious fact that such contaminants would prevent the adhesion of the Teflon coating to the metal surface of the slug.

To clean the slugs, put them into the kitchen sink. Fill the sink with hot water, along with a generous portion of dishwashing liquid. Allow them to soak until the water cools down enough to put your hands in it. Now, while wearing surgical gloves, scrub each slug with a toothbrush. Then toss the cleaned slug into the adjoining sink filled with clean, hot water. This rinse is important to remove the soap film off the bullet. When all the projectiles have been cleaned, drain away the rinse water.

Next, the bullets should be cleaned with solvent. Rubbing alcohol is probably the best choice for solvent because it's not so hard on the skin. Always wear latex surgical gloves for the procedure. Wet the slugs with solvent, then with a clean, solvent-soaked rag. Rub down the surface of the bullet, and place it aside to dry. You shouldn't be noticing much dirt showing up on your cleaning rag. If you do, use of a stronger solvent, such as acetone, may be required. Mineral spirits should be avoided, as a lot of the hardware store mineral spirits contain only contaminants. In any case, the slugs should be solvent cleaned until they don't leave a blemish on the scrubbing rag.

Etching

The acid etch of the projectile serves two purposes: to shrink the diameter of bullets so that a Teflon coating may be applied and still retain the original caliber, and to pit the surface of the metal so that the Teflon coating will find footholds in the metal surface in which to "grab" onto the surface and form an adherent coating. Teflon won't bond to a smooth surface. For this reason, it makes no sense to "undersize" them a little bit while

cutting them with the thought that after a coat or two of Teflon they will be puffed up to the proper caliber. They are better when cut at the correct caliber so that a proper etch of the metal can be done to shrink the bullet diameter prior to application of Teflon.

A more streamlined bullet shape is useful when penetrating armor. Once a good performer is found, stick with it. Many lathes are programmable, and can turn out identical slugs, one after another.

The chemicals used in the acid etch are found in most any hardware store. To etch steel slugs, hydrochloric (muriatic) acid is used. This material is generally sold in gallon jugs, and the manufacturer will often list the strength of the acid on the label in terms of degrees balme. At least 30% HC-1 is needed to get a good etch on steel, so for your convenience the following conversion between degrees balme and % HCl is given:

6.6 degrees balme = 10% HCl
10 degrees balme = 15% HCl
13 degrees balme = 20% HCl
16 degrees balme = 25% HCl
19 degrees balme = 30% HCl
22 degrees balme = 35% HCl

The higher quality steels are more resistant to the acid etch than is mild steel. To get a reasonably fast etch on these high strength alloys, one has the choice of using a more concentrated acid, or heating the acid bath, or both.

Hydrochloric acid is not strong enough for copper and brass. The preferred etchant for copper and its alloys (such as brass) is nitric acid. Full strength 70% nitric acid cut in half with water will zip through copper at the rate of one mil every couple of minutes at room temperature. Higher temperatures will result in considerably faster rates of etch.

To etch the projectiles, don surgical gloves, and then place the slugs on their base (pointed end of bullet up) in a glass baking dish. Use only the flat section of the bottom of the dish, as it will not do for them to fall over while being etched. They should also be spaced no closer than Vi-inch apart. There is a reason for this. The section of the bullet in contact with the glass dish won't etch as fast as that section which is in free contact with the etching solution. To maintain the proper round shape of the slugs, then, they must be placed base down and not in contact slow. It can take several days for 15% HC1 to etch down a mil or two through copper. Obviously, this with each other. The surgical gloves are needed to prevent getting greasy fingerprints on the bullets which would interfere with the etch.

Now to etch steel projectiles, pour into the baking dish hydrochloric acid of at least 10% strength for mild steel, and at least 20% strength for higher-quality alloys. The bullets should be completely immersed in the etch solution. Immediate and fairly vigorous fizzing should be noticed within a few seconds of immersion. This fizzing is an indicator of the rate of etch as the steel dissolves, as iron chloride and hydrogen are produced as a byproduct. With hardened steels, heating of the etch solution up to the neighborhood of 140° F or so is likely to be required to get a reasonably fast etch rate.

Every few minutes, remove a randomly selected slug, rinse it off in clean water, then measure its diameter with the micrometer to monitor the rate of etch on them. With these

steel projectiles, an etch of at least 2 mils (2 thousandths of an inch) below the proper caliber of the round is required. This will allow the Teflon coating 1 mil thick to be applied to the slug. On a steel projectile, this is enough to protect the barrel of the gun from damage, and also aid in the penetration of the target. A steel bullet can defeat armor simply on the basis of its hardness, so a thick coating of Teflon "grease" isn't required to ease its way through.

When the bullets have been etched to the desired degree, remove them from the acid bath, and rinse them with plenty of fresh water. Then rinse them in water containing some bicarbonate of soda to remove any acid remaining in the pits which would lead to rapid rusting of the metal, followed by another clean water rinse. If they are immediately going to be coated with Teflon, dry them thoroughly as quickly as possible to prevent rusting. If some time will pass before they are coated, then they should be sprayed down with WD-40 to prevent rust.

Coating

As was alluded to earlier, the basic procedure for applying a Teflon coating to metal is to dip, bake and then fuse the coating. The thickness of coating which results from one pass through this cycle will vary with the individual product being used. A coating thickness of from Vz to IV* mil (Vi to 1 Yz thousandths of an inch) is typical from the Teflon emulsions. The reason why the thickness of the deposit will vary from one product to another is mainly the viscosity of the resin emulsion. The "thicker" the emulsion's consistency is, the thicker the layer of resin which will cling to the metal. Since cooling down the emulsion will also cause it to become "thicker," the same product can give varying thicknesses of coating depending upon temperature. Another factor which influences the thickness of coating applied is the percentage of solids in the emulsion. As you could guess, the higher solids products will give a thicker coating.

To get a build-up of Teflon coating three mils thick from an emulsion that produces a coating one mil thick on a single dip-and-bake cycle, one simply runs the slug through the dip-and-bake repeatedly until the desired thickness of coating is achieved. Critical thickness is defined as the maximum thickness of coating which can be formed in a single pass through the dip-and-bake cycle without the formation of cracks in the coating when it is dried. Small cracks can be tolerated because they will melt shut when the sintering or fusing temperature is reached during the baking process, but large cracks will produce a lousy, non-aero-dynamic coating. The product will come formulated to produce a coating below the critical thickness, and it's best not to mess with it to try to get thicker coatings of Teflon per pass through the dip-and-bake cycle.

The first thing which must be done then, is to run a sample bullet through the dip-and-bake cycle to measure the thickness of coating produced on your slug. In general, the manufacturer's claim for their product can be taken as pretty accurate, but they should be checked. Also, it's quite possible that one may be using an emulsion that produces a coating of unknown thickness. This will be the case if one goes "jug in hand" to a plant which is in the business of Teflon-coating articles, and buys a jug of resin emulsion from them (There is much more on low-profile ways to come by Teflon emulsions in the next section of this book.) There is a further advantage to first running one sample projectile through the coating process, in that it gives you practice in the procedure, and allows you

to work out the bugs in your technique before moving on to a more assembly line production.

The dipping procedure will differ somewhat, depending upon whether one has steel slugs or the commercial, copper-jacketed items. With the steel bullets, one must first remove the coating of WD-40 that was applied after the acid etch to prevent the slugs from rusting during storage. To remove the WD-40, first soak the projectile in some acetone or toluene (obtained off the shelf at the hardware store paint section) to remove the vast majority of the coating, then transfer the slug to some fresh acetone or toluene to remove the rest. Then, while wearing surgical gloves to prevent smudging the metal, remove the bullet from the solvent and wipe it off with some clean paper toweling. This two-pot solvent dip won't help to make this single slug any cleaner, but once one is running a fair number of bullets through this process it will help a great deal, because most all of the WD-40 will be left in the first solvent pot, allowing a final rinse in clean solvent. One can't get the projectile any cleaner than the solvent used to rinse it.

There will be two guides for applying coating. One for Xylan and one for DuPont Teflon. Xylan is much easier and cheaper but less effective than Teflon.

Xylan coating

Now it's time to dip the item into the Teflon emulsion. With a steel slug, attach a magnet to the base of the bullet. Be sure that all the solvent has evaporated off the metal surface, then dip the slug nosefirst into the emulsion until it is almost all the way submerged up to the base. Then pull it out of the emulsion, and let the excess drip back into the emulsion. Keep the bullet nose facing downward for this drip, so that gravity assures that an even coating sticks to the sides of the projectile.

With a commercial copper slug, a magnet can't be used because neither the copper jacket nor the lead core will cling to a magnet. In this case, attach a clamp to the base of the slug, and dip it nosefirst into the emulsion until it is immersed just about up to the clamp. Then pull it out of the Teflon, and let it drip off nose downward.

The next thing which should be done is to let some of the solvents evaporate off the coating. This can be done by just letting it dangle in the air for about ten minutes. One can speed up this process by using infrared heat lamps or blowing hot air from, for example, a hair dryer. When one scales up production and has a number of slugs dangling next to each other, one must be careful that any blown hot air doesn't cause them to bang into each other and mess up the coating. Ditto for magnets bumping into each other and sticking a couple of slugs together.

At the conclusion of this preliminary solvent evaporation, the Teflon coating has a gooey, tacky consistency. It will not airdry to a solid film. There are two reasons for this. The first reason is that Xylan contains some solvents that aren't easily evaporated off at room temperature. The second reason why it won't set at room temperature is that the resin matrix that contains the Teflon emulsion is a thermosetting resin. It requires a bake to make it cure.

Preheat the oven to 450° F. Now hang the slug, still attached to its clamp or magnet, from the oven rack with some wire. Be careful not to let the coating touch anything. Bake for 15 minutes at 450° F. This sets the Xylan into a dry, very slick coating.

After the bake process is over, remove the slug from the oven, and allow it to cool back down to room temperature. Once cooled, the thickness of the coating can be measured by using the micrometer to see how much the diameter of the projectile has increased. It's very important that this measurement be done at room temperature, as metal expands with heat.

This one coat of Xylan will be enough for a steel projectile, as the main benefit of the coating on a steel slug is to protect the gun barrel from damage. A commercial copper-jacketed bullet will need more than one coat to aid its penetration. At least three mils build-up are required. To get this build, a somewhat modified procedure must be followed. Additional coats of Xylan won't stick to an undercoat of Xylan if it has been baked to 450° F. To pile one coat over an existing coat of Xylan, the bake must be done at 300° F for 15 minutes. Only with the final coat that ultimately reaches the desired thickness of Teflon is the baking done at 450° F. In the case of these multiple coats of Xylan, the final bake at 450° F should be done for a more extended time, 20-25 minutes. Other than this variation in the temperature of bake, the procedure for applying coat over coat of Xylan is the same. One just dips the slug into the emulsion. Then the excess is allowed to drip off nose downward. This is followed by about ten minutes of air drying, followed by a bake.

DuPont Teflon coating

Getting a good, adherent coating of pure Teflon is considerably more difficult than applying Xylan. The use of a DuPont acid primer is mandatory to get good adhesion to the metal surface. Much higher baking temperatures are also needed with the pure Teflon coating. Further, while the primer is loaded with Teflon resin emulsion, it doesn't produce a really nice, slick coating. The primer, once applied and cured, should be overlaid with a DuPont Teflon top-coat to get a properly Teflon-coated bullet.

The metal preparation for applying Teflon is identical to that for Xylan, and the overall procedure is also quite similar. One starts with a steel slug suspended with a magnet attached to its base, or a commercial, copper-jacketed bullet clamped at its base. It is next dipped into the primer, either the 851-204 pre-mixed primer or the 850-3XX two-pack-age primer to which the 35 parts by volume of VM-7799 acid accelerator has been added to 100 parts of 850-3XX. The primer must be gently agitated just prior to use to get the Teflon resin evenly dispersed in the primer. The container holding the primer must be acid-resistant to keep it from being eaten through or dissolving metal plating on the container. This metal contamination of the primer will ruin it. A glass measuring cup is quite suitable, as is a cutout bottom of a plastic milk jug.

With the slug properly suspended, dip it into the primer to the same depth as is the case with Xylan. Similarly, then, withdraw it and allow it to drip off nosefirst back into the pot of primer. This is followed by an airdrying of the coating. Some heat is quite helpful for this process, but drying temperatures in excess of 180° F must be avoided because this would force the water and other volatile ingredients out of the coating too fast and result in bubbles forming in the coating. At the end of the airdry, the coating is solid, and can be touched gently without ruining the coating. Greasy Fingerprints will prevent the top coats

from sticking to the primer, so surgical gloves should be worn if the Teflon is going to be touched.

The airdry is followed by an ovenbake to cure the coating and to drive out wetters and other more difficult to evaporate ingredients. The oven is preheated to 450° F, as is the case with Xylan. Similarly, hang the slug from a wire hook attached to the oven rack and bake for 20 minutes.

It is possible to use just this primer coating on a steel projectile. One should measure the thickness of coating achieved by the dip in primer the same way as with Xylan. It will be around one mil. If only this single coat is going to be applied, the Teflon must next be sintered or fused. This is a higher temperature bake which melts the Teflon resin contained in the coating and produces a much stronger, more adherent film that also displays considerably better non-friction properties. A temperature of 675° to 750° F is used for this fusion step. The oven at the plant where I work has no problem reaching these temperatures, but the dial on my stove at home doesn't go that high.

There is a way around this problem. The broiler of a home oven does attain this temperature range. First, one must determine at what distance from the broiler heating element the desired temperature is reached. For this, one needs a reliable thermometer. Thermometers which measure this temperature range are easily available from many sources.

Next, take this thermometer, and coat the bulb or other temperature-sensing area of the temperature probe with a coat of Teflon. This coating is required because a broiler heating element primarily heats on the basis of radiated heat, rather than hot air surrounding the object. One wants the temperature probe to have the same radiation absorbing qualities as the slugs, so it should be coated.

Now, after the Teflon coat on the thermometer bulb area has dried and been baked, put it on a baking pan and stick it under the broiler. Find the distance from the broiler element(s) where the desired temperature is reached. Then put your Teflon-coated slug on the baking pan, base down, and put it under the broiler at that distance from the heating element which gives the desired temperature. Heat for a period of 5 to 8 minutes. It should be evident that the coating has fused, or melted. Any small cracks that may have been in the coating should be melted shut. A small amount of soot may also appear on the surface from the presence of some residual wetter.

Normally, one doesn't just want to be satisfied with the primer coating. For a commercial copper-jacketed slug, a build-up of at least 3 mils is necessary. The performance of steel projectiles is also improved by following the primer with the application of a top coat. To get the top coat to stick to the primer, the sintering bake on 675° to 750° F must be delayed until the desired build-up is achieved. So, following the cure bake at 450° F, one allows the bullet to cool. Then it is dipped into one of the DuPont top coats mentioned earlier: 851-214, 851-221, 851-224 and 851-255. The top-coat Teflon emulsion must be gently agitated just prior to use. This substance isn't acidic, so one doesn't have to worry about the kind of container being used to hold it, or about getting it onto the skin. The main health concern with this material concerns smoking. If you get Teflon resin smeared onto a cigarette, it will make you sick. Be warned.

Following the dipping into the top-coat, allow the bullet to drip off, then air-dry it. Air-drying at 120° to 140° F will help to prevent cracking or bubbling of the film during the oven bake.

Next, pre-heat the oven to 600° F. If your oven only goes up to 550° F, just add 5 to 10 minutes additional bake time. Now put the slug into the oven, hanging from a wire hook attached to the magnet, or clamp it to the oven rack. Bake at 600° F for 10 to 15 minutes, or 550° F for 15 to 20 or 25 minutes.

After the bake, the projectile can be removed from the oven and allowed to cool. The high-build products will give a thicker coating than 851-221, and are the only products to use to build up thick layers of Teflon. Additional coating thickness is achieved by allowing the bullet to cool, and dipping it again into the top coat, followed by drip, air-dry, and bake.

When the desired build-up has been reached, the sintering or fusing bake should be done as described earlier. Just remove the slug from the magnet or clamp after the cure bake at 600° F, and put it base-down on a baking pan and broil (or bake, if you have the proper oven) at 750° F for 18 to 25 minutes. The longer time and higher temperature are due to the thickness of the coating, and the nature of the top coat versus the primer. Some soot may be noticed on the surface of the Teflon from the destruction of residual wetter. This can be wiped off with a solvent-soaked rag.

When the desired thickness of coating has been reached, one is ready to reload the slug into a cartridge and do some test firing. The most important property to test for is good adhesion to the metal substrate. Fire a slug into a tank of water, and recover the slug for examination. The coating should look pretty good, with rifling marks on the side of the slug.

Next, a more demanding adhesion test can be done by shooting a slug into a bunch of packed cotton wadding. The Teflon in this case should show some wear, but should not be flaked or peeled off in a wholesale manner. One can next move up to phone books, stacks of newspapers, etc.

Poor adhesion can be caused by a variety of factors:

1. Insufficient roughness and pitting of the metal surface. This is quite unlikely in the case of steel projectiles, as the acid etch will generally produce a surface as rough and pitted as a com cob. Copper gets a finer-grained etch in general, and additional roughening by means of sand or bead-blasting, or other abrasive methods could be called for, such as coarse sandpaper.
2. A dirty, greasy metal surface. Good metal cleaning and the wearing of surgical gloves will prevent this source of adhesion problems.
3. Incomplete fusion of the Teflon coating. Increasing the time of the fusion bake, and making sure that the proper temperature is being reached, will cure this.

Once one has worked out any bugs in the coating process, it's an easy matter to dip and bake fairly large numbers of projectiles at a time.

Bullet Sizing Die

I am using commercially available .38 bullets for this example. Changed sizes of the die will make it viable for other bullets. Bullet sizing dies are used for making the bullets the appropriate size before they go into the rest of the ammunition. The homemade re-sizing die is nothing more than a modified section of box section tubing. I am using 30 x 30mm tube with a wall thickness of 2.5mm. The length of the tube is also 30mm, just to keep things simple. For accuracy of drilling a drill press must be used to make the die. The first step is to drill a 2mm or 3mm pilot hole through the centre of the tube section. The hole must pass through both walls. Next, the hole is enlarged to 5mm or 6mm, and then the final 8.9mm hole is drilled (carefully and slowly) again making sure the drill passes through both walls. The holes can be made by simply holding the tube section on the drill table with your hand and drilling the holes. It is not necessary to clamp the tube or hold it in a vice.



Drilling the die holes.



Drill the tube.



Solder the nut.

We now have the main body of a simple sizing die through which to pass our bullets. The next step is to simply solder an 8mm (M8) nut to the inside wall of the die in alignment with one of the holes, as shown in the above photo.

An 8mm bolt, 2" in length, is now screwed into the die. It should screw freely in and out. The bolt allows us to press the bullet through the opposite hole. The finished die is shown on the next page.

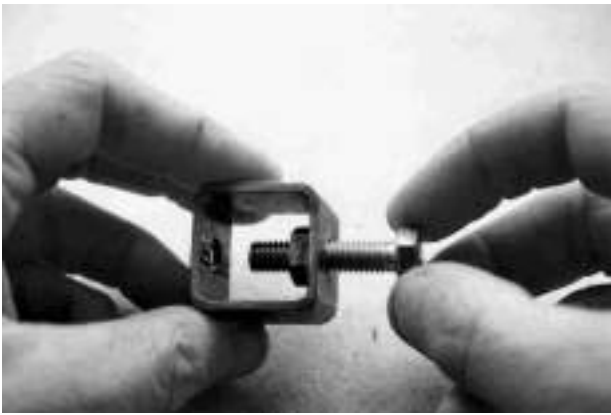

Screw in the die bolt.



The finished die tool.



Press the bullet through the die.

Shell Casings

The shell/cartridge casing is what will hold the entire round together. There are two types of cartridge casings, known as the 'straight-walled' model and the 'bottleneck' model. The 'straight-walled' model is easier to make. The procedure written here is based on the .38 special round, although it can be modified to suit any round.

Get the appropriate brass tube. If it needs to be smaller, the size can be reduced by squeezing the brass tube through multiple dies. Some ammunition (such as .38 special) is already an off the shelf tube: 3/8".

The vernier gauge is set to 30mm, and as shown in the photos below, used to scribe a line around the tube. This is achieved by simply rotating the tube against the sharp point of the gauge. This section of tube, measuring 30mm, is now removed. The scribe mark is the point at which the tube is cut. Brass tube is harder to cut than ordinary copper plumbing tube so a good quality plumbers tube cutter is required. I emphasize 'good quality'. It is perfectly possible to buy a good quality cutter for around £10. It is well worth spending an extra few pounds as it will make tube cutting an easier prospect.

The tube cutter should be carefully rotated clockwise and anti-clockwise so as to allow the section of tube we require to be removed. It is important not to rush the tube cutting

procedure as this may cause the cutting wheel to wander leading to an inaccurately cut case.



It is of great importance to ensure that one end of the tube section (from here on referred to as the case) is perfectly square. To achieve this the case is placed in a drill press and the spinning case lowered onto a flat file, as illustrated in the above photo. It should be noted that the drill chuck should be tightened by hand only so as not to distort the roundness of the case. This method of case trimming is just as accurate as using a small lathe and no different in principle to the case trimmers used in conventional re-loading practices. Remember to measure the case. Following the trimming operation the case is measure to ensure it has an overall length of 29mm. The correct case length is very important.

Now that we have the main body of our .38 case it is necessary to attach the case rim. To achieve this we require a small 'micro' pencil gas torch, a 3/8" curtain ring, and some solder paint. Solder paint is a mixture of flux and powdered lead solder.

The .38 case rim consists of a 3/8" curtain ring. These can be found in most good hobby and craft shops and usually have 'Rings and Clips' printed on the pack. The clips should be discarded as they are not required. It is very important to make sure the rings have an inside diameter of 3/8".



A matchstick or small artists paintbrush is used to apply a small amount of solder paint to the squared end of the case. Ensure that the solder is fully covering the circumference of the case.



Solder the rim.

The ring is now placed in the center of a section of steel rod, around 1" in diameter, as shown above. The painted end of the case is then inserted into the ring. It must be ensured that the case is inserted fully and the end of the case resting against the top of the rod. The pencil torch is now used to solder the ring to the case. Only a small amount of heat is required to melt the solder so it is important not to "over do it". Allow the case to cool for thirty seconds or so and then carefully remove the case and place it to one side while the next case is soldered.

Another ring could be added inside the case, to function as the primer hole. It has to have the diameter of the case's opening and itself the opening of the primer's diameter. It will also lay slightly deeper inside the case, to give the anvil's legs space.

The case must be passed back and forth across the surface of a file several times to remove any solder residue. The inside of the case mouth must also be completely deburred using a knife.

For the simple manufacture of moderate quantities of .38 cases, the tube and ring method is perhaps ideal for the hobby gunsmith. Once the necessary quantity of tube sections are cut and trimmed to their correct length, cases can be manufactured quiet quickly.



A collection of finished cases.

The procedure will have to be modified for the 'bottleneck' cartridge case. The angle of the taper will have to be known so that the case reaches the correct diameter over the correct length. The case is to be tapered by using the short tapered mandrel. The case could also be tapered by using a die. Make the die by boring the piece of steel with the correct taper for the outside of the finished tube. Anneal the cartridge casing

Primers

The primer is what will cause the propellant to detonate when the hammer of the firearm strikes the round. The primer will contain the most sensitive explosives the ammunition will have.

- Blanking press.
- Cupping press.
- Brass sheet. Preferably made of cartridge brass.
- Non-corrosive primary explosives. DDNP and lead azide are good, but phosphorous trisulfide works fine.

Make a blank out of the brass sheet with the blanking press. Make the blank a cup shape in the cupping press. Tumble the parts to remove the sharp edges at the open end of the cup. An appropriate washer could be put around the primer to better fit the case if needed. The anvil will now be manufactured. The anvil is the part that will crush the explosives to activate the primer. It is also the smallest part of a round. Place brass sheets into the blanking press with multiple blanking punches to shape the sheet into the anvil. There are multiple types of anvils that can be used.

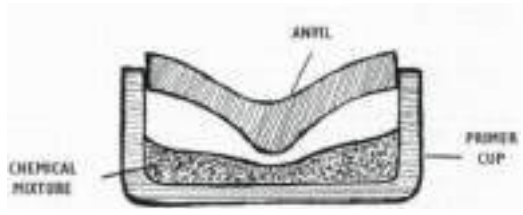
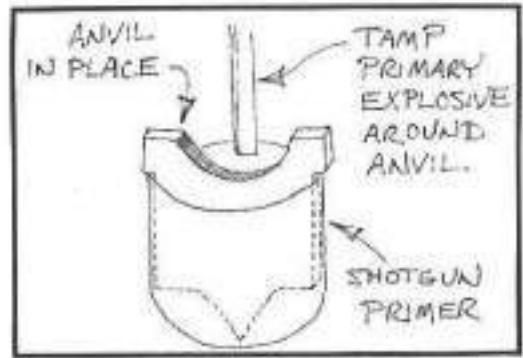
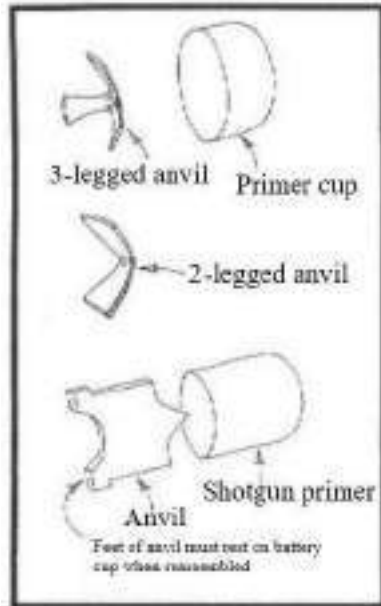

Fill the primer cup level full. Then use the rear end of a wooden match stick or any non-metallic, non-sparking tamper to pack down the primary explosive. Tamp gently at first, then push down with increasing firmness. Although the powder you are tamping is dry, it can be (and must be!) compressed to the point where none falls out when the primer cup is tipped upside down and tapped lightly. The primary explosive in factory-made primers is coated with lacquer to seal out moisture. Although a dab of nail polish does not seem to interfere with ignition, I don't know how effective it is in sealing out moisture. Would it last ten years? Who knows.

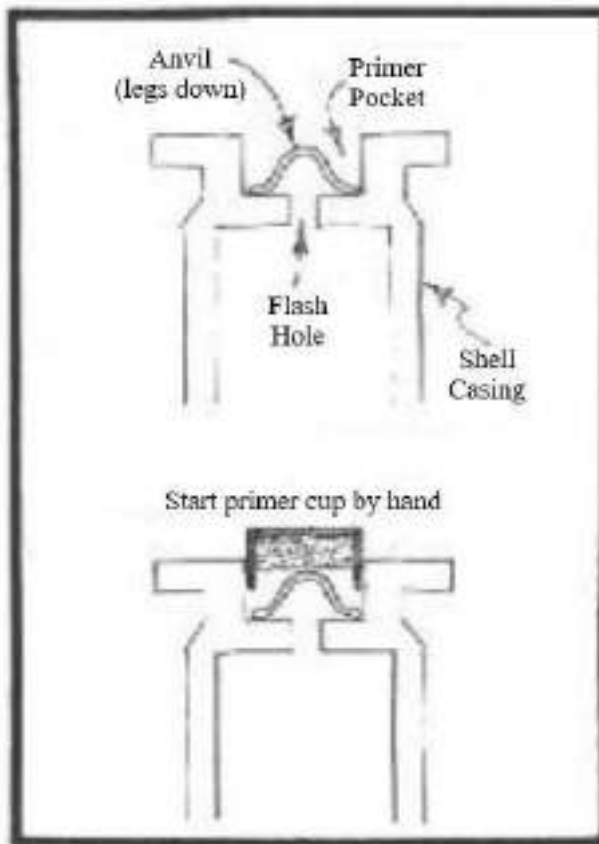

How to attach a primer to a cartridge case.

The metal “ring” that makes the flash hole could be improvised with a metal ring with the circumference of the inside circumference of the shell casing.

Using blanks as primers

In this procedure, a .38 special case is used and will be primed with the widely available 8mm Fioochi blanks. In some cases, blanks will not be accessible. If they are, this method is much cheaper and easier than to make the primer all by yourself.

The blank must be disassembled before it may be used to prime our .38 cases. This is a simple procedure involving the removal of the blanks tip and green plastic plug liner, leaving us with a primed empty 8mm case.

The fioochi 8mm blank case is actually manufactured from steel as apposed to conventional brass. The blanks are used in a wide array of blank firing pistols for re-enactments and training purposes where a real firearm would be unwise, or just general fun usage by replica gun collectors. They are a strong and reliable method of priming the improvised cartridge case.

The first step is to use a tube cutter to remove the tip of the blank. It will be necessary to hold the blank in a pair of pliers to do this as the blank is a small component. Once the tube cutter has cut through the case wall, both ends of the blank are gripped in pliers and both halves pulled apart. In doing so the green plastic insert will be removed. The section containing the green plastic plug is discarded.



Remove the blank tip.

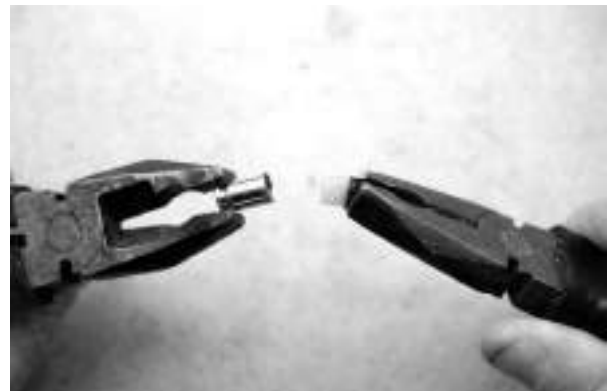

Pull the blank apart.

A bit of twisting and pulling will be required to separate the two halves but this is not difficult. The above photo shows the tip removed.

The blank can now be measured. It should be somewhere between 13mm and 15mm in length. The exact length not being too important. Before we can use the blank cases to prime our .38 cases we must make a small brass sleeve insert, so as to permit the blank to fit the .38 case. For this sleeve we require a simple 15mm length of 11/32” brass tube.

A 15mm, or thereabouts, length of 11/32” brass tube is cut and measured. The tube just acts as a ‘filler’ between the outer diameter of the blank and the inside diameter of our .38 case.

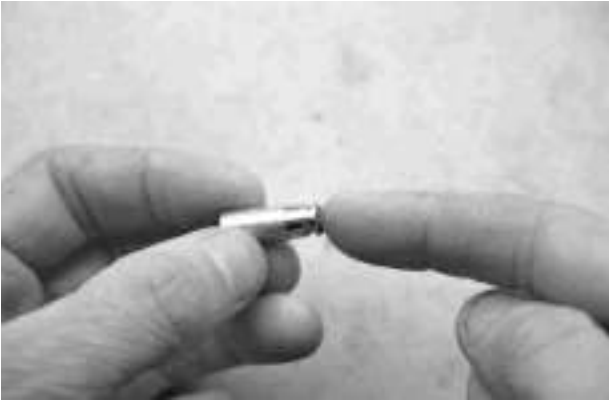

Press the blank into the sleeve.



Insert the priming assembly into the case.

After de-burring one end of the sleeve we can bond the blank and sleeve together. The outside of the sleeve is coated with a high strength retainer such as 'bearing adhesive' and the blank inserted into the sleeve. Do not use 'Super Glue'. The blank and sleeve priming assembly can now be inserted into our .38 case. Retainer is now applied to the outer circumference of the sleeve and the assembly inserted into the .38 case, as shown in the above photo.



The primed case.

The above photo shows our newly primed case with the priming assembly in place. At each point of inserting the blank into the sleeve and the sleeve and blank into the case, the base of each assembly should be placed against a flat surface to ensure all inserts are completely flush with each other. The primed case must now be put to one side while the retainer has time to harden. We may use this "drying time" to prime more cases.



Remember: the anvil is to crush the explosive between the cup and the anvil in order to ignite it. Make sure it is a shape which allows it to compress the explosive and push against the case. You do not want a loose anvil.

Propellant

The propellant should be less sensitive than the primer's explosives. For improvised explosives, black powder and nitrocellulose works best. Lower quality DDNP and lead azide would possibly work very well. Match-heads and firecracker powder also works but is not desirable. Black powder and firecracker powder will produce much smoke. The weight of other primary explosives in match heads $\times 0.75 =$ the minimal amount of other smokeless powder. Smokeless powder is relatively more powerful than most of the explosives that can be improvised and used as propellant.

Ammunition.	Match heads.	Ammunition.	Match heads.
Rifle ammunition.		Handgun ammunition.	
.22 Hornet.	13.	9mm Parabellum.	8.
.222 Remington.	26.	.38 Special.	15.
.223 Remington.	39.	.357 Magnum.	26.
.243 Winchester.	61.	.45 ACP.	27.
.30 M1 Carbine.	16.		
.30-30 Winchester.	45.	Shotgun ammunition.	
7.62 mm NATO.	58.	12 Gauge.	33.
.30-06.	74.	16 Gauge.	30.
.375 H&H Magnum.	87.	20 Gauge.	27.
.44 Magnum.	32.	.410 Bore.	19.
.45-70 Govt.	76.		
.458 Winchester.	79.		

Bullet Seating Equipment

This guide uses the .38 special case. The procedures can be executed for other rounds if the sizes are adjusted.

Before our newly primed cases can be charged with powder it is necessary to make a simple shell holder. To make the shell holder we require two washers. Both washers are 1" in diameter. One washer must have a 1/4" hole and the second a 1/2" hole. The two washers must be soldered together and for this we require some solder paint and our gas torch. Again, I am using a pencil torch due to its small size and more accurate flame. The photo below shows the complete shell holder and a handmade .38 case ready for loading.



Washers ready to solder.

Before the washers can be soldered together the zinc surface should be removed by simply sliding the washers over a file several times. To solder the two washers together place the washer with the 1/4" hole on a flat surface and apply solder paint to its circumference. Place the second washer (1/2" hole) on top of the first. Apply heat to the washers until the solder runs. Now leave the assembly to cool. If, as sometimes occurs, the washers 'slide' out of alignment with each other during soldering, the washers may be soldered on a wooden board and four tacks may be used to hold the washers in alignment. Simply place a tack at the 12, 3, 6, and 9 o'clock points around the washers. The wooden surface allows the tacks to be pressed in by finger pressure only and permits their easy removal after soldering. The small amount of heat required will not burn the wood unduly but it's best not to use the best dining room table!



In the above photo I am soldering the washers together on top of a section of steel tube, but as pointed out earlier, it is sometimes easier to use the board and tack method. The purpose of the shell holder is to protect the primer in the base of the case from coming into contact with any object that may cause the primer to detonate unintentionally. It is of great importance when reloading ammunition and although it is a very simple component it's importance should not be overlooked.

Now that we have our supply of resized bullets we can begin the reloading process and start seating bullets into our cases. But before this can be done a simple 'bullet seating die' must be made.

The purpose of the die is to ensure bullets are driven into the cartridge case accurately. The die is made from a simple section of hardwood. I am using a section of banister rail, and a 50mm diameter washer with a 10mm diameter hole. We also require an 8mm diameter bolt, 50mm (2") long and two nuts to fit the bolt. Any section of hardwood will do and ideally it should be around 1" in diameter. The rail section I use was actually 45mm in diameter but it was easy to obtain so I used it . Whatever wood section is used, it should measure about 45mm in length.

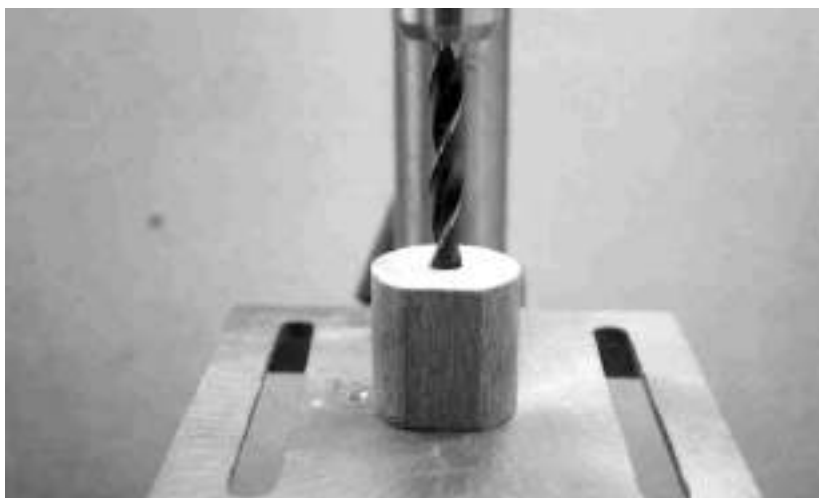

Drilling the bores.

As shown in the photo on the previous page, a hole is drilled through the center of the die. A drill press must be used for this purpose. We must drill two separate diameter bores through the die, one to accept the case and the other the bullet. It is of vital importance that both ends of the die are perfectly square before attempting to drill any of the bore holes. The first hole to be made is the 'Case Bore' to accept the cartridge case. This is drilled to a diameter of 9.9 or 10mm (25/64"). The second hole to be made is the 'Bullet Bore' to a diameter of 9mm (23/64"). The bullet bore must be drilled first.

The two bores must be drilled slowly. At regular intervals during drilling the drill handle should be raised and any wood shavings released from the bit. This will ensure the bores are drilled as cleanly as possible. To drill the bullet bore hole, hold the die on the drill table and slowly drill all the way through the center of the die, regularly releasing drill pressure to allow shavings to be removed. Do not move or rotate the die once the first hole had been made. Lower the drill table and remove the drill. Now place the 9.9mm 'Case Bore' drill in the chuck and carefully raise the drill table back into alignment with the new drill bit.

Now carefully drill the second bore to a depth of 30mm. This is the bore that will accept the cartridge case in due course. The bores of the die should now be inspected to ensure they are clean and true. It is a good idea to insert each of the two drill bits just used back into each bore and rotate them several times by hand to remove any slight imperfections or wood shavings. The top washer can now be screwed to the bullet bore end of the die. A washer of similar diameter to the die should be used, in my case 50mm. Drill a couple of holes either side of the washers 10mm hole and countersink each hole. Now use a couple of short screws to attach the washer to the die. Now attach the two nuts to the bolt and insert the bolt into the die. The die is now ready for use.

The two nuts act as an adjustment method to alter as necessary the depth to which a bullet is seated.



The finished seating die.

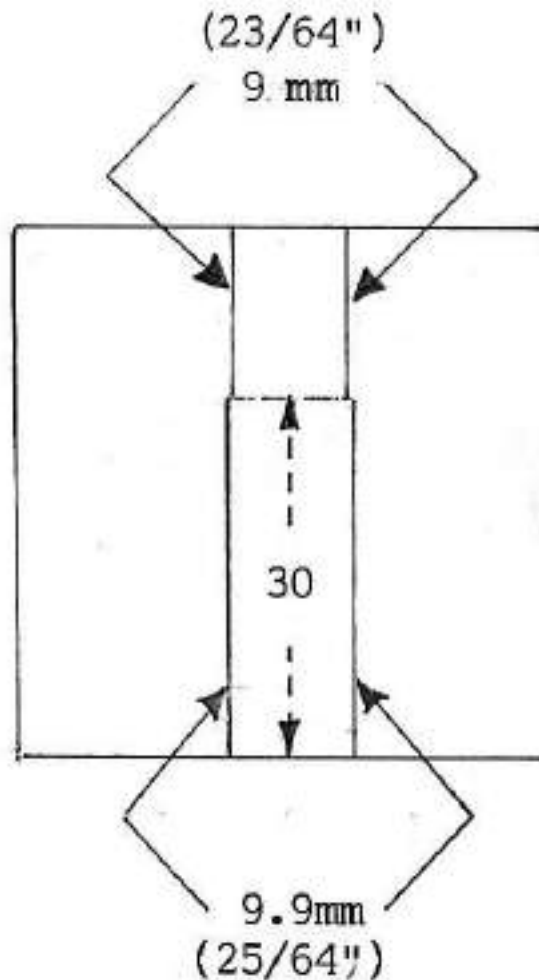

Bullet seating die dimensions
for the .38 special.

Assembling Ammunition

This guide is for the .38 cartridge, but can be modified for any other round by adjusting the sizes.

The .38 cases are now ready to load. The primed case is first placed in the shell holder and the die inserted over the case. The powder charge is then poured into the dies bullet bore.



Insert the die over the case.



Insert the bullet.

The resized bullet is now inserted into the die. The seating bolt is now inserted over the bullet. Note that the two nuts are initially screwed onto the bolt a distance of about 3/8" to begin with.



Insert the bolt.



Tap the bolt home.

The seating bolt is now tapped with a hammer, or preferably a hard rubber mallet. The bullet will be driven into the mouth of the case. Adjust the two seating bolt nuts as necessary so as to allow the bullet to be seated until the overall length of the loaded cartridge is 37.5mm. The length of the cartridge should be measured using the vernier gauge.

Adjust the bolt nuts gradually during the seating of the first bullet until the cartridge measures 37.5mm. Once the nuts are 'set' at this position all future cartridges can be loaded without touching the two lock nuts again.

The loaded improvised cartridge compares favourably with its factory made counterpart. Once the necessary materials are acquired and the simple loading tools made, reloading these .38 Special cartridges is nearly as easy as loading using conventional reloading methods.



Complete rounds ready for use.

Full Metal Jacket

Full metal jacket (FMJ) bullets are lead bullets encased in an outer shell (“jacket”) of harder metal such as gilding metal or cupronickel. Recycled brass casings or brass strips may also be used. The jacket may not cover all of the lead bullet but doing so is less optimal. Do the calculations that the bullets will fit the case after being jacketed.

Shotgun Shells

Here is a guide for 12 gauge shells and .410 shells. The sizes can be adjusted for other shells too. 12 gauge shells are the most common.

If, for whatever reason, you cannot buy your 12g shells from a store, you may need to construct your own improvised 12g ammunition. The following document illustrates how 12g shells can be easily and quickly constructed with just a few simple tools and components.

Products required:

- 25mm MDPE pipe stiffeners.
- 15mm wood dowel.
- 15mm plumbing olives.
- 8mm rubber nut caps.
- Hot glue gun.
- Shot - (Lead or BB's).
- Black powder.
- Primer.

The main body of the shell is a simple MDPE pipe stiffener available from any good trade-plumbing outlet. The ones pictured below are used for common blue 25mm MDPE water pipe. The stiffener (from here on referred to as the shell) is 20.3mm in diameter. The shells inside diameter is 17mm. Pipe stiffeners do vary slightly in dimension from maker to maker so the manufacturing techniques illustrated here are based on the pipe stiffeners I used in the writing of this document. Any 25mm pipe stiffener may be used, but they may require slightly more trimming.



A 25mm pipe stiffener shown alongside a standard 12g shell.

The first step is to reduce the rim of the shell to a thickness of 1.5mm (or thereabouts) using a flat file. The shell is passed 'back and forth' over the file until the rim is the correct thickness. This is a quick and simple procedure. During the trimming procedure rotate the shell a quarter turn every few 'passes' to ensure the rim is evenly reduced.



Reduce the rim.

Insert the primer into the side with the rim. 2 plumbing olives around a dowel section with a drilled hole through can hold the primer firmly in the shell. The base of the shell showing the assembly in position, effectively priming the shell ready for loading. Ensure the assembly is completely 'flush' with the end of the shell base.



Insert the cap.

After loading the powder charge an 8mm rubber nut cap is pressed into the shell using the finger, as shown in the above photo. Obviously this should be done with the shell in a

vertical upright position and not as I am showing it in the above photo. Now press the nut cap fully home using a pencil. Tamp it down onto the powder charge. The nut cap will be a close press fit inside the shell.

After pressing the nut cap firmly into place, load a charge of lead shot (or steel BB's) into the mouth of the shell until the top of the load is just below the shell mouth. I loaded a charge of fifty five or so steel BB's. Now insert another nut cap (open end into the case) and press in firmly.



Load the shot.



Insert the nose cap.

If necessary, adjust the amount of shot to allow the cap to be inserted to the correct depth.

The nut cap in position, effectively sealing the mouth of the shell and holding the shot charge in place. A bit of experimentation should be carried out by the loader as to how much shot is needed to allow the cap to be fitted correctly. As shown above, a shallow 'V' shaped gap should exist around the cap after fitting.

To finish off our improvised 12g shell it is only necessary to glue the cap in position using a hot glue gun. The one I am using here cost a mere £2.99. It is perfectly adequate for the job. Ensure the gun is fully heated and place a bead of glue around the mouth of the shell.



Applying the glue.

When applying the glue it is far easier to rotate the shell in the fingers, rather than trying to move the gun around the shell mouth!



It should look similar to this when finished.

The shell mouth is now completely sealed, as shown above. The glue acts as the crimp found on any factory or professionally home loaded shotgun shell. The finished 12g shell compares favorably to those commercially available.

.410

If, for whatever reason, you cannot buy your .410g shells from a store, you may need to construct your own improvised .410 ammunition. The following document illustrates how .410 shells can be easily and quickly constructed with just a few simple tools and components.

Products required:

- 15/32" (11.9mm) brass tube.
- 13/32" & 7/16" brass tube.
- Primer.
- 4mm thick cork sheet.
- Lead shot or BB's.
- Hot glue gun.

The first step in constructing these improvised .410 shotgun shells is to purchase some lengths of brass tubing. This material is commonly available from most good hobby and craft shops. We require three lengths of tubing; 15/32" from which to construct the shell (a 2 1/4" length is required) and some 13/32" and 7/16" for the priming assembly. Cut a 2 1/4" length of the 15/32" tube using a plumbers tube cutter.

The rim of the improvised .410 shell is a simple 15/32" (12mm) Circlip. The clip is fitted to the end of the tube as illustrated above. It may be secured using retainer or soldered in position with either conventional solder wire or solder paint. However, if solder is used the clip must be fitted BEFORE the priming assembly is installed, for obvious reasons!

The clip must then be trimmed, using a file, to remove the two plier holes present on the clips open end. At this point it is also necessary to check how much trimming the clip requires to allow it to chamber in your particular shotgun. It is useful to have a standard .410 shell handy as a guide by which to compare your improvised shell. Care must be taken to ensure the clip is fitted securely and correctly.

The next procedure is to make two small wads to retain the powder charge. For this we need a sheet of 4mm thick cork sheet. This material is widely available from most good hobby and craft shops. Using the open end of the shell, or a separate length of the 15/32" shell tubing, press the end of the tube into the cork sheet. This should be done twice.

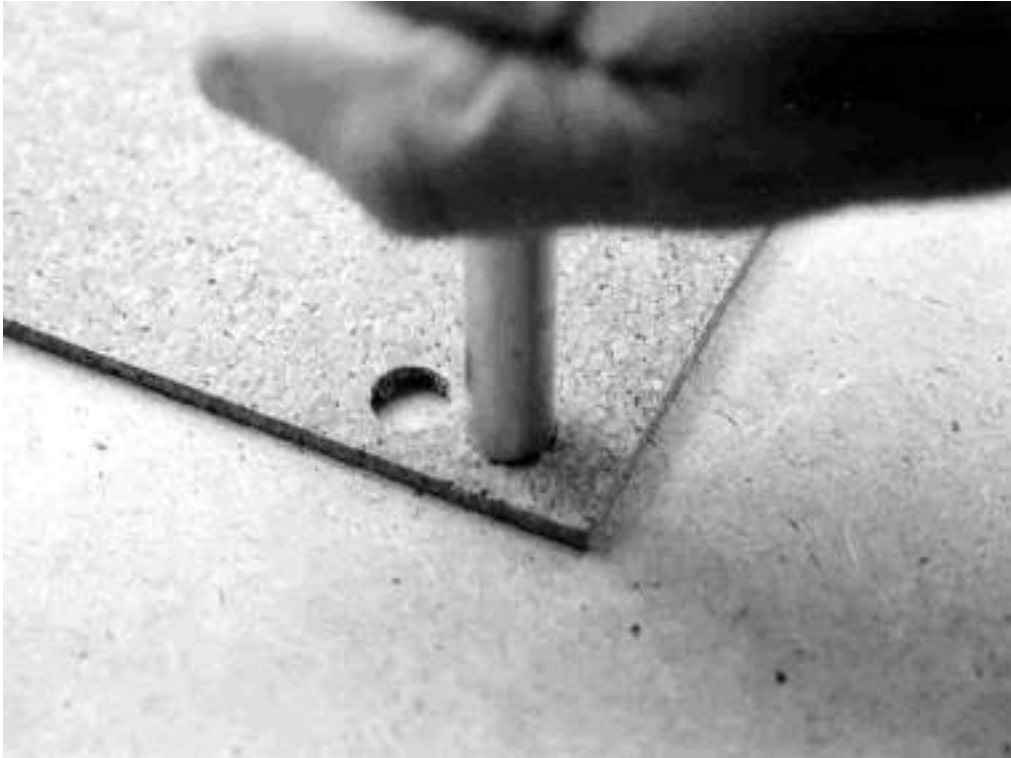

Press the tube into the cork to create two 'over powder' wads.



Insert the wads over the charge.

The shell is now ready to charge with powder. Either black or smokeless may be used, but if using a smokeless charge, make sure you adhere fully to the recommended charge spelt out in your reloading manual for the particular type of powder you are using. If black powder is used the shell should be filled to a third of it's length, or thereabouts. After charging the shell press the two wads into the shell as shown above and tamp them firmly down over the powder charge.

Now charge the shell with your lead shot or steel shot. Ensure the top of the charge is just below the shell mouth.

Using a hot glue gun, fill the end on the shell mouth with glue. It is important to "score" the inner wall of the shell mouth using a sharp nail, or similar object, in order to provide a 'key' for the glue to stick to. The glue will effectively seal the shell and apply a crimp at the same time. The glue should fill the end of the shell mouth.



Leave the shell for several minutes for the glue to set.

Round Diagrams

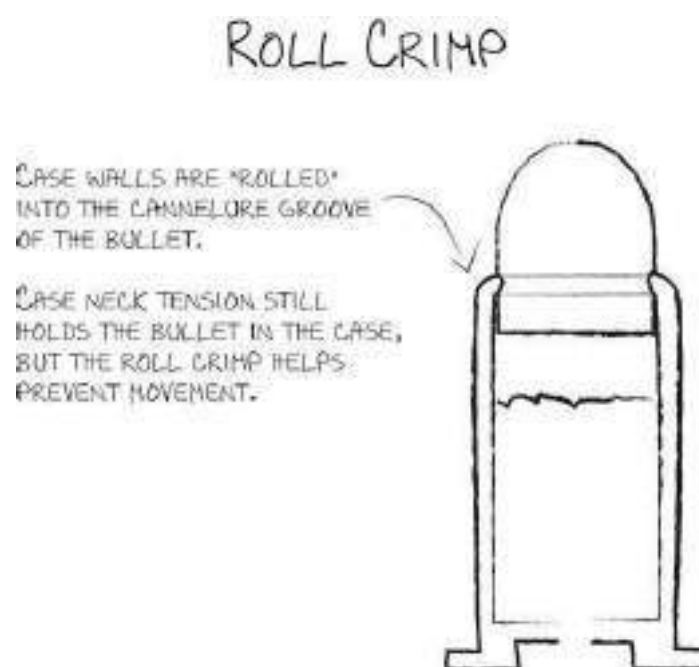

Not every bullet has a cannelure groove or is roll crimped. Below are 3 dies from Dillon designed to progressively taper a case. Note one creates the neck, one crimps and one tapers. Add the primer last.

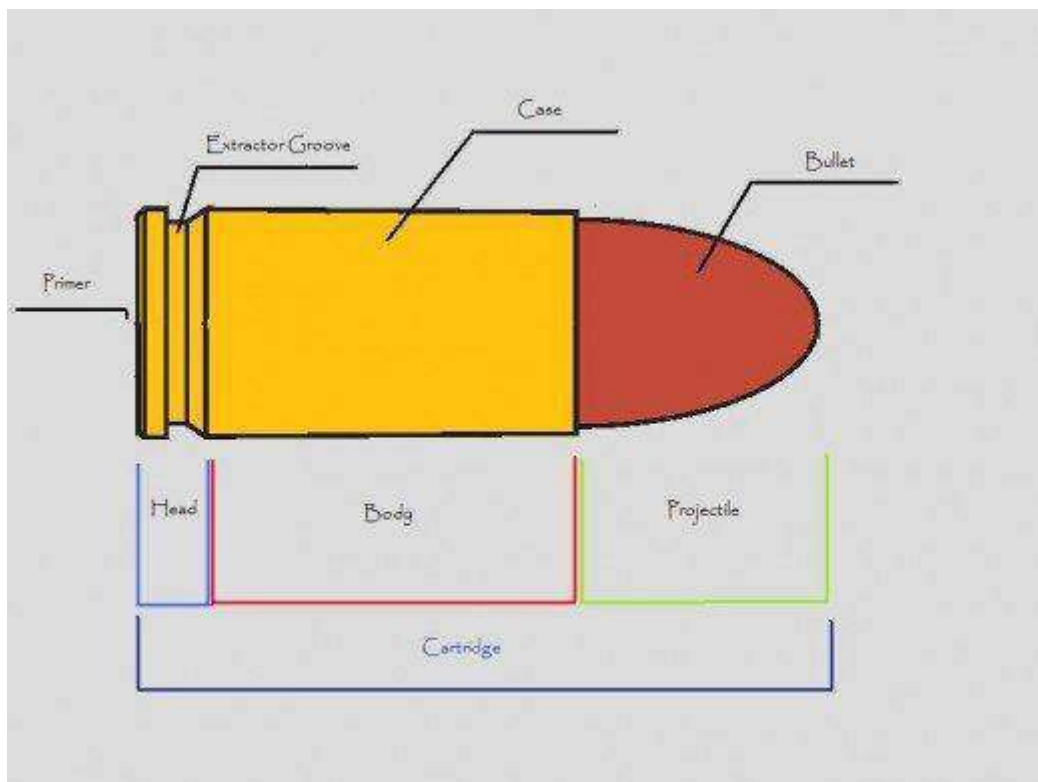

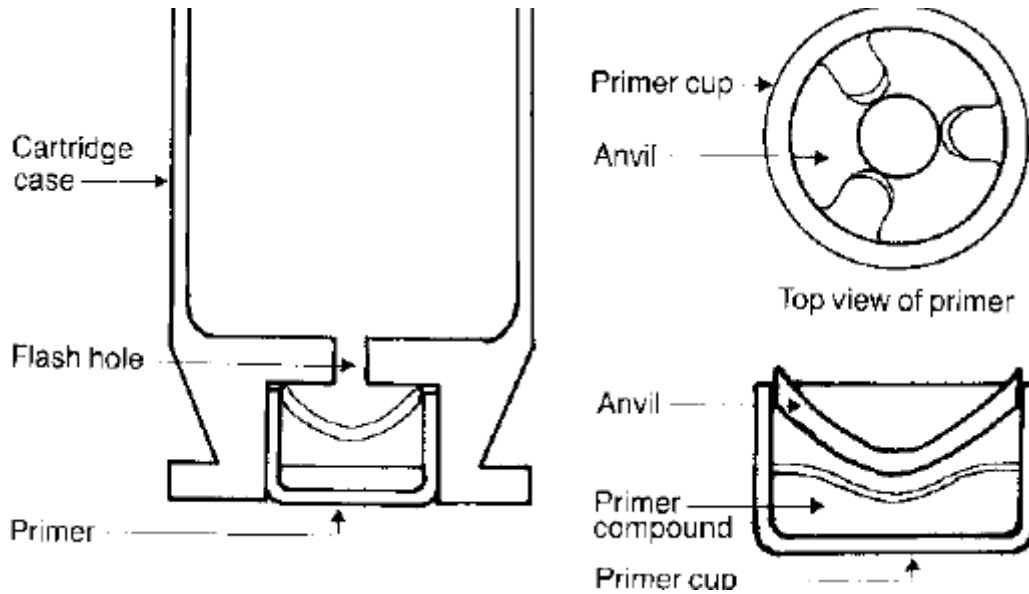
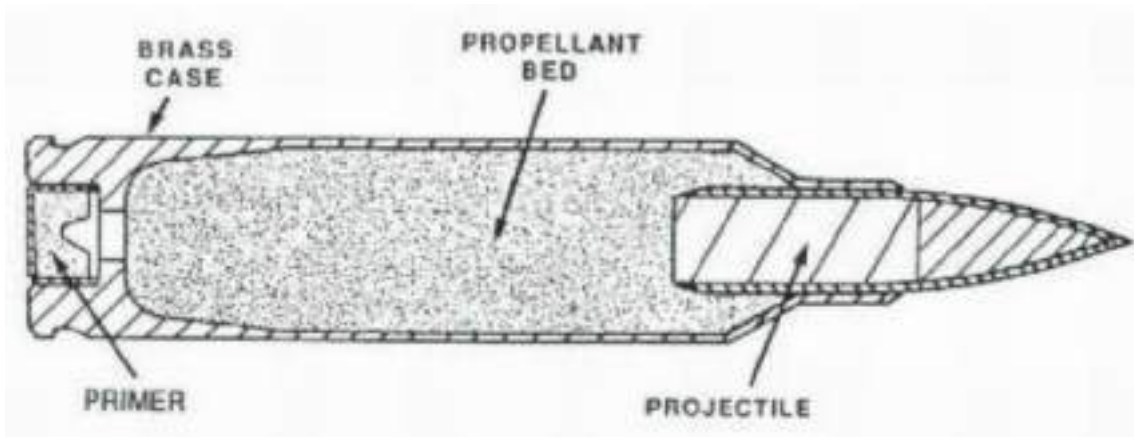

Now the dimensions for different rounds, including:

- .22 Long Rifle.
- .22 K-Hornet.
- 9mm Parabellum.
- .38 Special.
- .32 ACP.
- .380 ACP.
- 5.56mm NATO.
- Winchester .380.

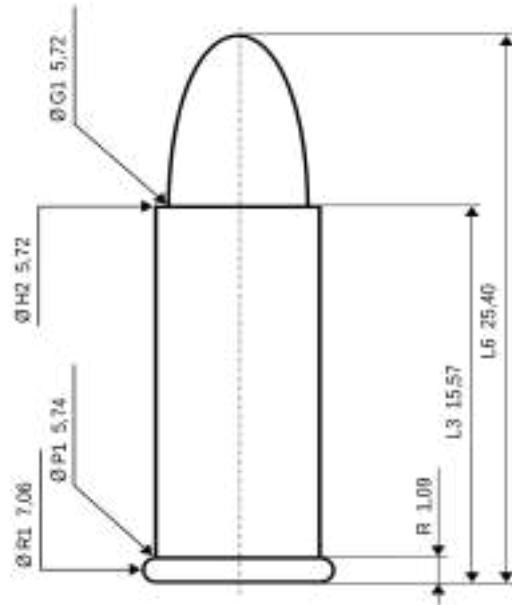
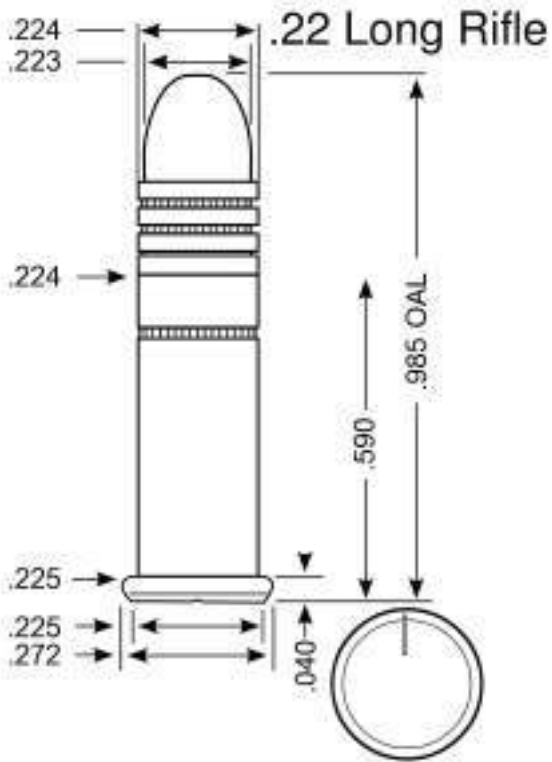

Dimensions for the .22 LR case. The details on the case on the diagram to the left may be ignored

.22 K-Hornet (40°)

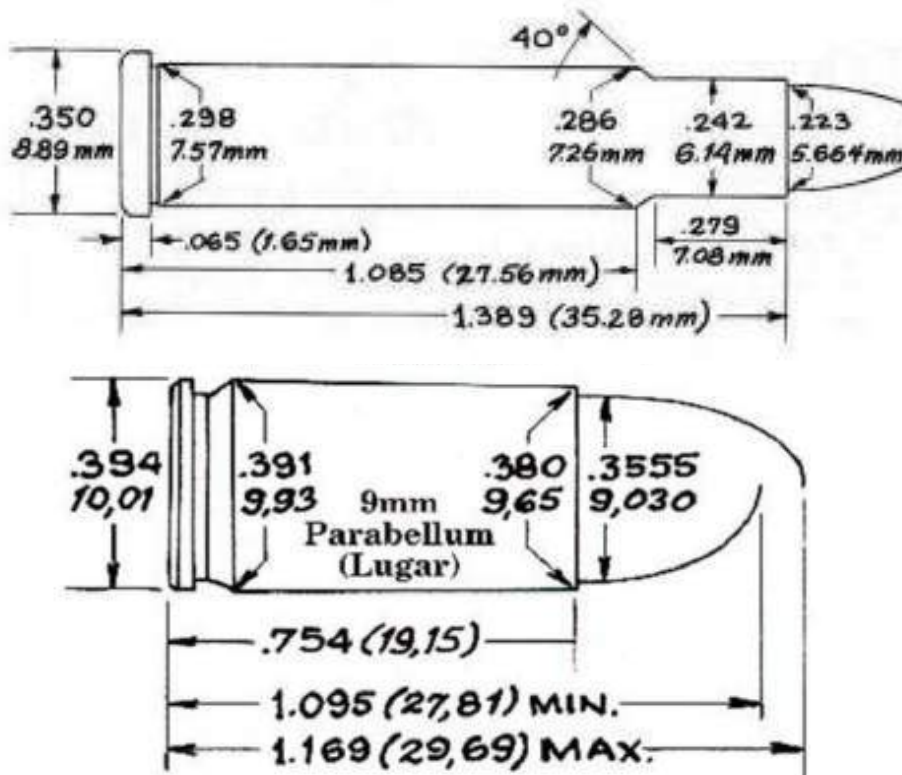

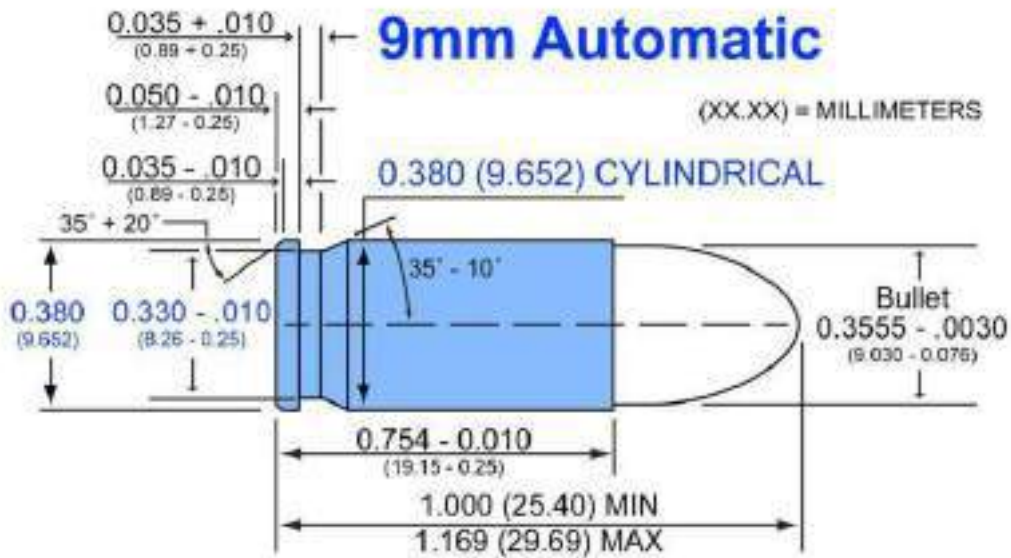

.38 SPECIAL

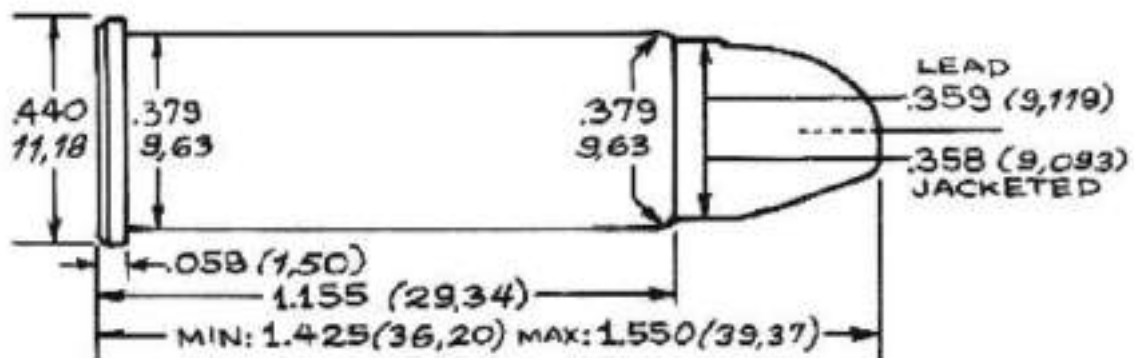

SECTION I - CHARACTERISTICS
CENTERFIRE PISTOL & REVOLVER
SAAMI VOLUNTARY PERFORMANCE STANDARDS

CARTRIDGE & CHAMBER
38 SPECIAL
38 SPECIAL +P

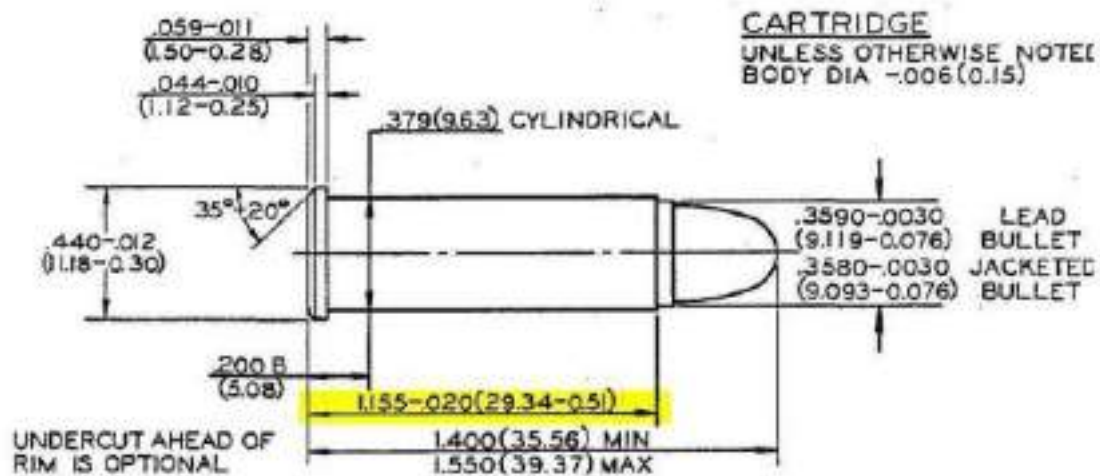

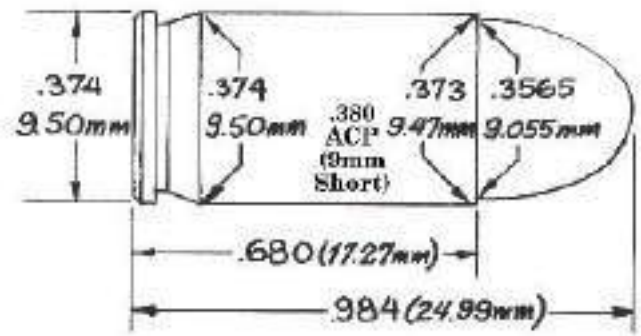
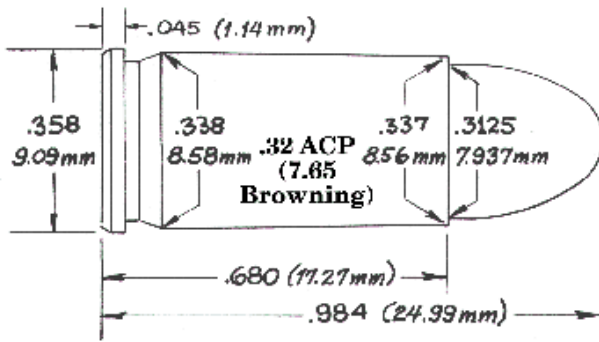

5.56mm NATO

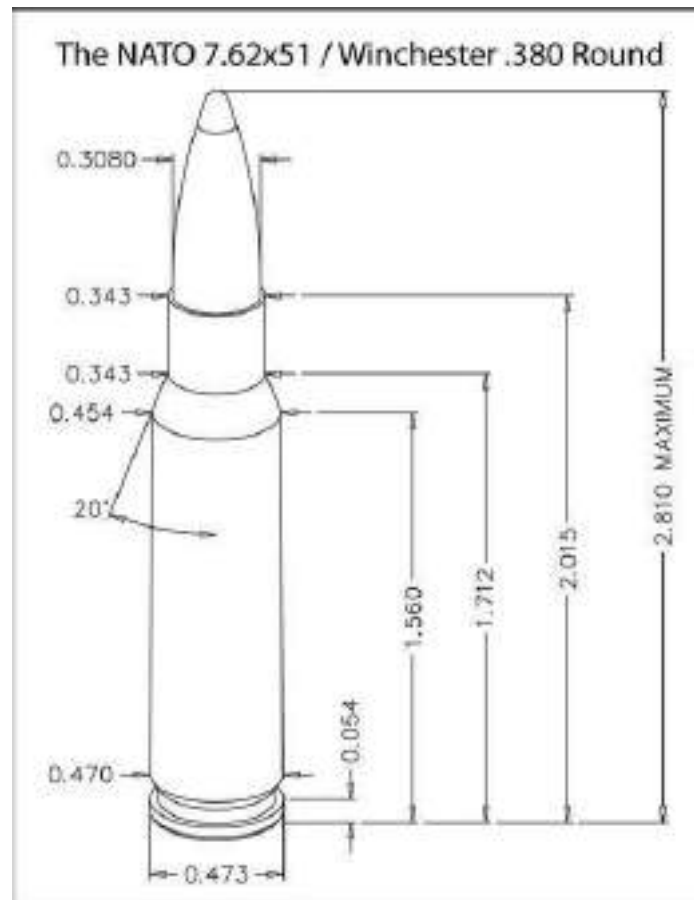
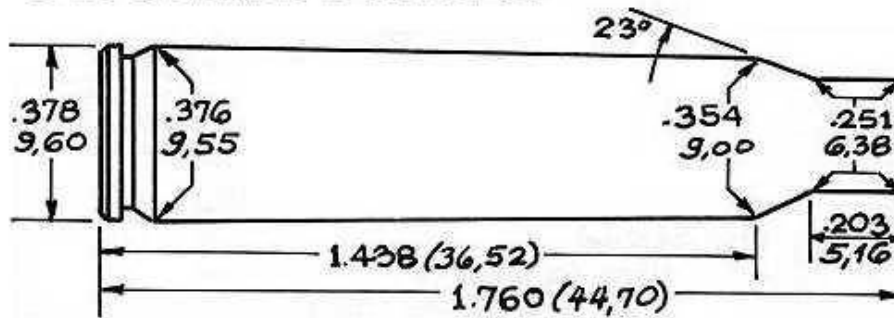

CHAPTER X: FIREARMS

Nomenclature

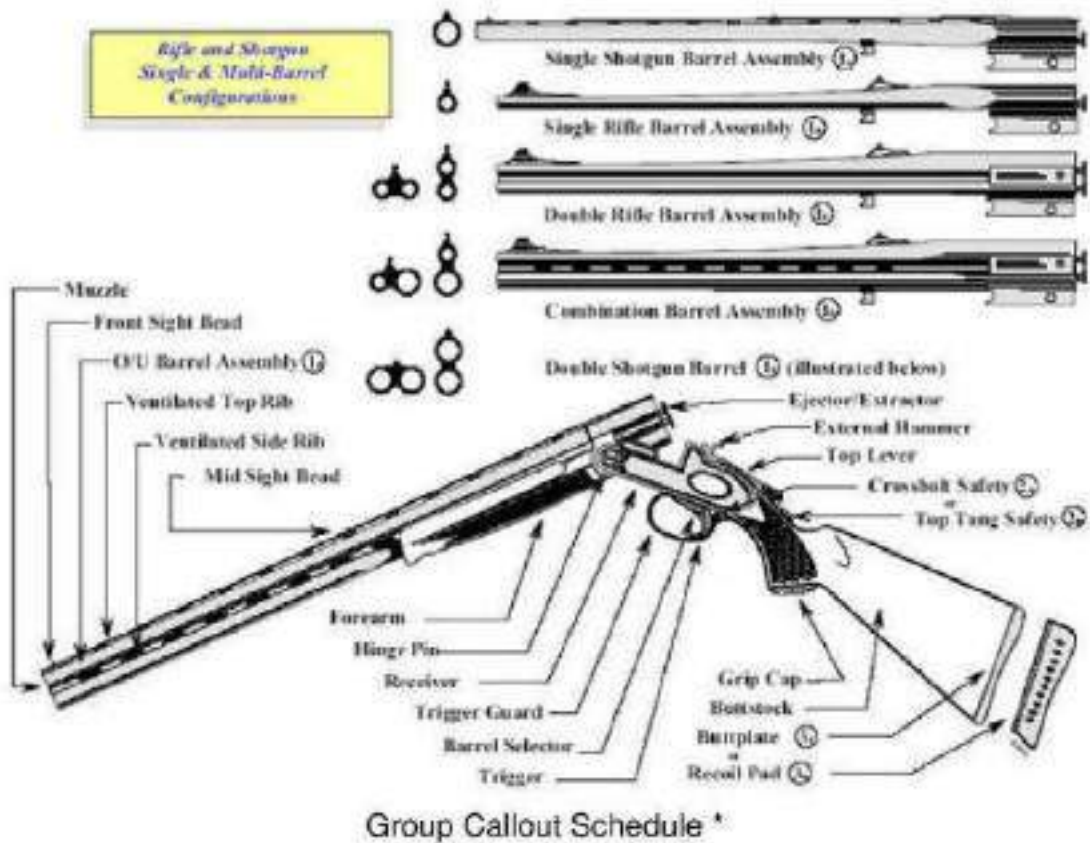

Group (1)	Various barrel configurations which may appear on this type action. A-Single Shotgun, B-Single Rifle, C-Double Rifle, D-Combination, E-Double Shotgun
Group (2)	Two safety configurations which may appear on the available models. A-Crossbolt, B-Top Tang
Group (3)	Two buttstock appointments available in this group. A-Buttplate, B-Recoil Pad

Break-action diagram.

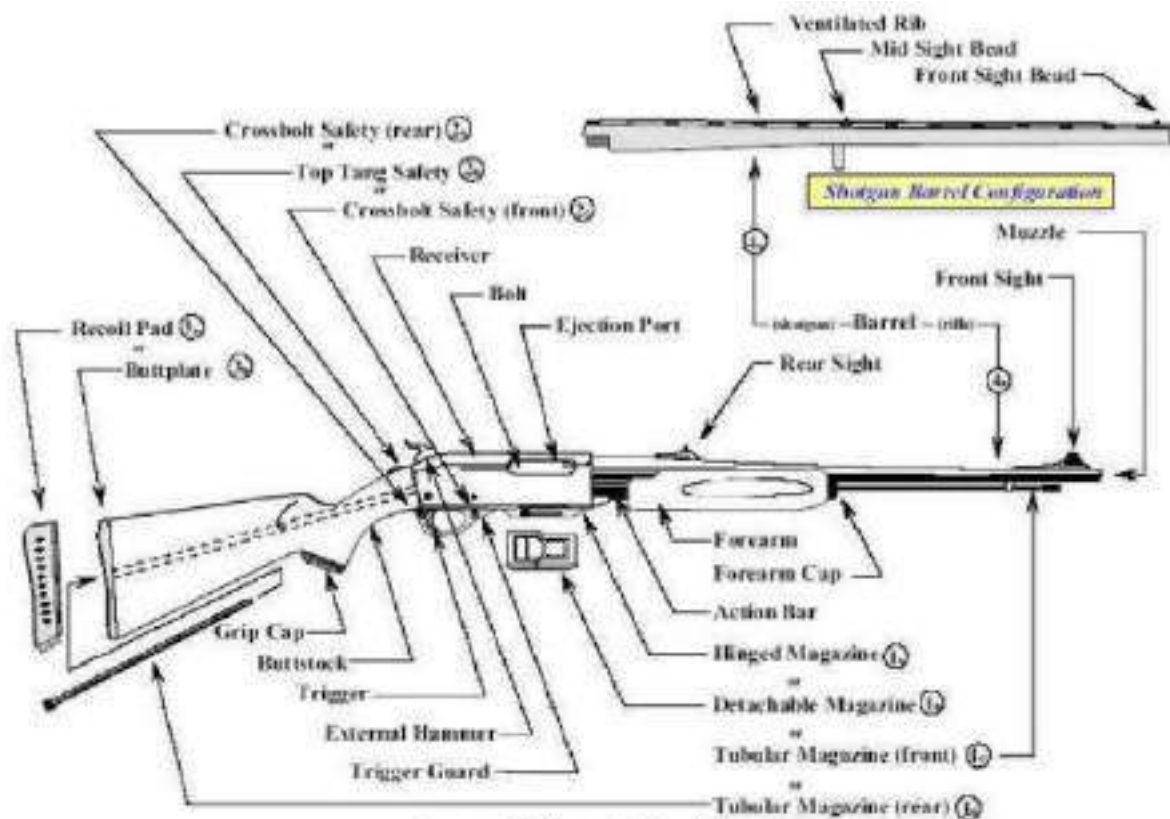

Group Callout Schedule *

Group (1)	Three magazine configurations available on this type action. A-Hinged, B-Detachable, C&D-Tubular (Front and Rear)
Group (2)	Four various safety configurations which may appear on the available models. A-Crossbolt (front or rear), B-Top Tang
Group (3)	Two buttstock appointments available in this group. A-Recoil Pad, B-Buttplate
Group (4)	Two barrel configurations which may appear on this type action. A-Smooth Bore, B-Rifled

Pump-action diagram.

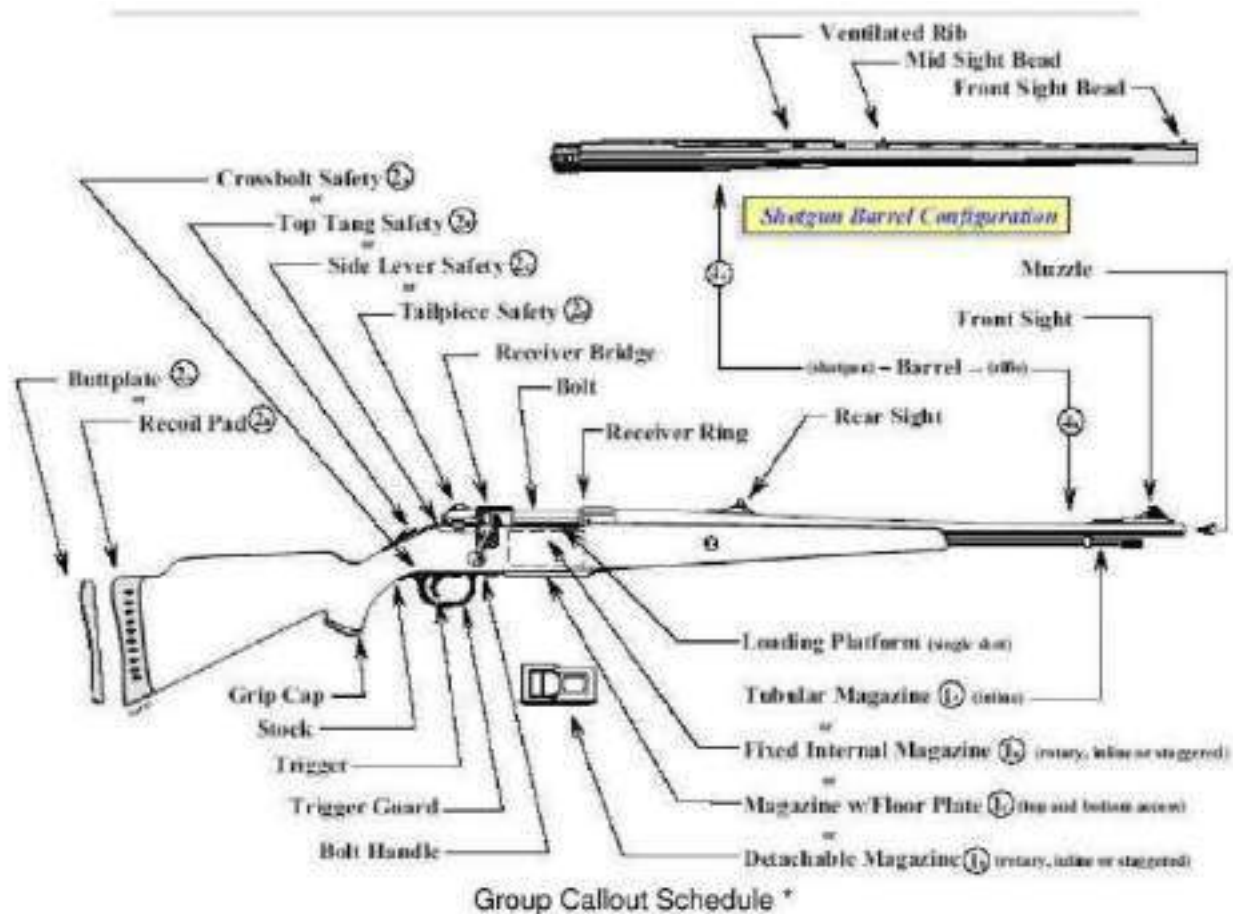

Bolt-action diagram.

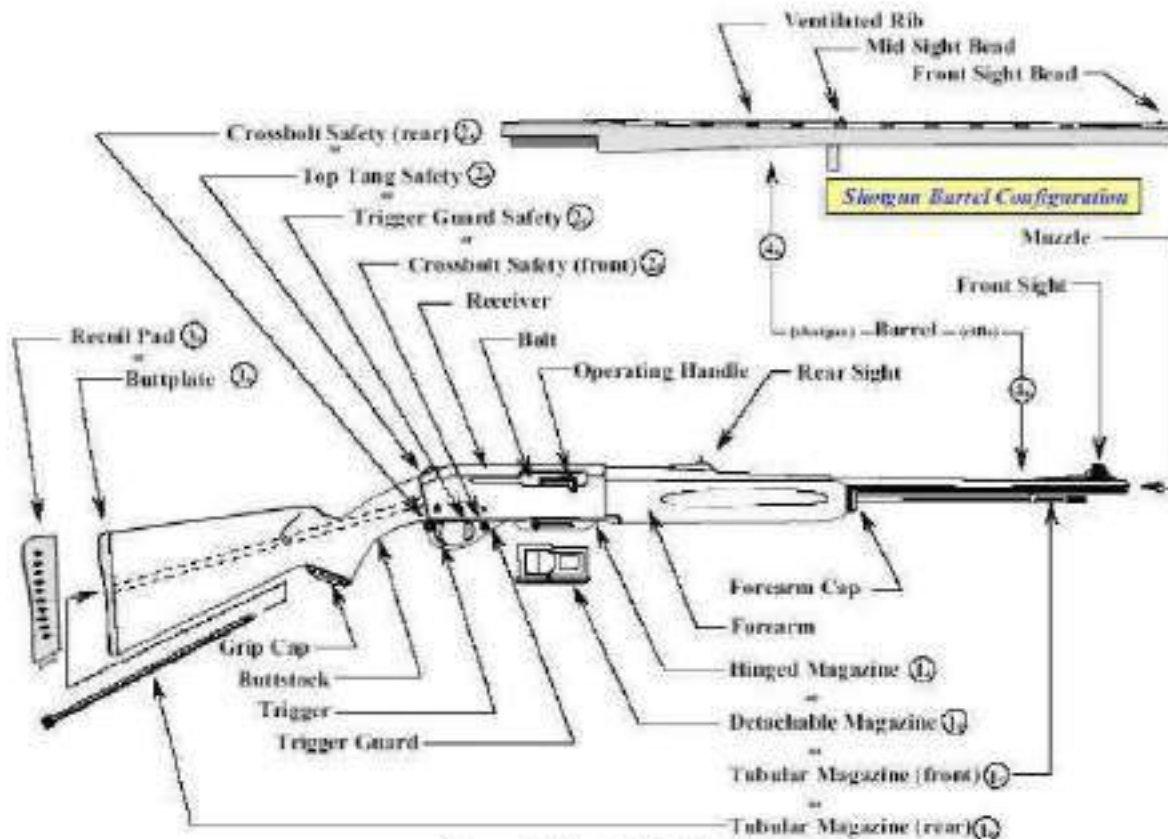

Group Callout Schedule *

Group (1)	Three magazine configurations available on this type action. A-Hinged, B-Detachable, C&D-Tubular (Front and Rear)
Group (2)	Four various safety configurations which may appear on the available models. A-Crossbolt (front or rear), B-Top Tang, C-Trigger Guard
Group (3)	Two buttstock appointments available in this group. A-Recoil Pad, B-Buttplate
Group (4)	Two barrel configurations which may appear on this type action. A-Smooth Bore, B-Rifled

Semi-automatic diagram.

- Action: The physical mechanism that manipulates cartridges and/or seals the breech. The term refers to the method in which cartridges are loaded, locked, and extracted from the mechanism. See diagrams above.
- Ammunition or ammo: Gunpowder and artillery. Since the design of the cartridge, the meaning has been transferred to the assembly of a projectile and its propellant in a single package.
- Automatic fire: A weapon capable of automatic fire is one that will continually expend ammunition for as long as the trigger is held.
- Barrel: A tube, usually metal, through which a controlled explosion or rapid expansion of gases are released to propel a projectile out of the end at high velocity.
- Belt: An ammunition belt is a device used to retain and feed cartridges into some machine guns in place of a magazine.
- Bipod: A support device that is similar to a tripod or monopod, but with two legs. On firearms, bipods are commonly used on rifles and machine guns to provide a forward rest and reduce motion.
- Blank: A type of cartridge for a firearm that contains gunpowder but no bullet or shot. When fired, the blank makes a flash and an explosive sound (report).
- Bolt: The part of a repeating, breech-loading firearm that blocks the rear opening (breech) of the barrel chamber while the propellant burns, and moves back and forward to facilitate loading/unloading of cartridges from the magazine. The extractor and firing pin are often integral parts of the bolt.
- Breech: The part of a breechloader that is opened for the insertion of ammunition.
- Caliber: In small arms, the internal diameter of a firearm's barrel or a cartridge's bullet, usually expressed in millimeters or hundredths of an inch; in measuring rifled barrels this may be measured across the lands (such as .303 British) or grooves (such as .308 Winchester) or; a specific cartridge for which a firearm is chambered, such as .44 Magnum.
- Cartridge: The assembly consisting of a bullet, gunpowder, shell casing, and primer. When counting, it is referred to as a "round".
- Chamber: The portion of the barrel or firing cylinder in which the cartridge is inserted prior to being fired. Rifles and pistols generally have a single chamber in their barrels, while revolvers have multiple chambers in their cylinders and no chamber in their barrel.
- Chambering: Inserting a round into the chamber, either manually or through the action of the weapon.
- Clip: A device that is used to store multiple rounds of ammunition together as a unit, ready for insertion into the magazine of a repeating firearm.
- Disassembly: The removal of parts of a firearm, usually as part of a field strip.
- Discharge: Firing a weapon.
- Drum magazine: A type of firearms magazine that is cylindrical in shape, similar to a drum.
- Dum-dum: A bullet designed to expand on impact, increasing in diameter to limit penetration and/or produce a larger diameter wound. The two typical designs are the hollow point bullet and the soft point bullet.
- Dummy: A round of ammunition that is completely inert, i.e., contains no primer, propellant, or explosive charge.
- Extractor: A part in a firearm that serves to remove brass cases of fired ammunition after the ammunition has been fired. When the gun's action cycles, the extractor lifts or removes the spent brass casing from the firing chamber.

- Field strip: Disassembling a firearm for the purpose of repair or cleaning, without tools. When using tools, this is called a detail strip.
- Firing pin: The part of a firearm that strikes the primer, discharging the round.
- Gauge: The gauge of a firearm is a unit of measurement used to express the diameter of the barrel.
- Grain: A unit of measurement of mass that is based upon the mass of a single seed of a typical cereal. Used in firearms to denote the amount of powder in a cartridge or the weight of a bullet. Since 1958, the grain (gr) measure has been defined as precisely 64.79891 mg
- Gun serial number: A unique identifier given to a specific firearm. Illegally trafficked guns have these filed off.
- Hammer: The function of the hammer is to strike the firing pin in a firearm, which in turn detonates the impact-sensitive cartridge primer.
- Headspace: The distance measured from the part of the chamber that stops forward motion of the cartridge (the datum reference) to the face of the bolt. Used as a verb, headspace refers to the interference created between this part of the chamber and the feature of the cartridge that achieves the correct positioning.
- Holographic weapon sight: A non-magnifying gun sight that allows the user to look through a glass optical window and see a cross hair reticle image superimposed at a distance on the field of view. The hologram of the reticle is built into the window and is illuminated by a laser diode.
- Iron sights: A system of aligned markers used to assist in the aiming of a device such as a firearm, and exclude the use of optics as in a scope. Iron sights are typically composed of two component sights, formed by metal blades: a rear sight mounted perpendicular to the line of sight and consisting of some form of notch (open sight) or aperture (closed sight); and a front sight that is a post, bead, or ring.
- Jacket: A metal, usually copper, wrapped around a lead core to form a bullet.
- Jam: A type of firearm malfunction, in which a bullet does not load properly and gets stuck.
- Magazine: A magazine is an ammunition storage and feeding device within or attached to a repeating firearm. Magazines may be integral to the firearm (fixed) or removable (detachable). The magazine functions by moving the cartridges stored in the magazine into a position where they may be loaded into the chamber by the action of the firearm.
- Muzzle: The part of a firearm at the end of the barrel from which the projectile exits.
- Muzzle velocity: The speed at which a projectile leaves the muzzle of the gun. In conventional guns, muzzle velocity is determined by the quality (burn speed, expansion) and quantity of the propellant, the mass of the projectile, and the length of the barrel.
- Pistol grip: A feature on some firearms that gives the user a slightly curved area to grip, just rear of the trigger.
- Rack: To pull back and then release the slide to eject a round if it is chambered.
- Receiver: The part of a firearm that houses the operating parts.
- Recoil: The backward momentum of a gun when it is discharged. In technical terms, the recoil caused by the gun exactly balances the forward momentum of the projectile, according to Newton's third law. Also called kick.
- Red dot sight: A type of reflector (reflex) sight for firearms that gives the user a red light-emitting diode as a reticle to create an aimpoint.
- Ricochet: A rebound, bounce or skip off a surface, particularly in the case of a projectile.

- **Rifling:** Helical grooves in the barrel of a gun or firearm, which imparts a spin to a projectile around its long axis. This spin serves to gyroscopically stabilize the projectile, improving its aerodynamic stability and accuracy.
- **Safety:** A mechanism used to help prevent the accidental discharge of a firearm in case of unsafe handling.
- **Silencer:** A device attached to or part of the barrel of a firearm to reduce the amount of noise and flash generated by firing the weapon. Also known as a suppressor, sound suppressor, and sound moderator.
- **Slamfire:** A premature, unintended discharge of a firearm that occurs as a round is being loaded into the chamber.
- **Sling:** A type of strap or harness designed to allow an operator carry a firearm (usually a long gun such as a rifle, carbine, shotgun, or submachine gun) on his/her person and/or aid in greater hit probability with that firearm.
- **Squib load:** A firearms malfunction in which a fired projectile does not have enough force behind it to exit the barrel, and thus becomes stuck. Squib loads make the firearm unsafe to shoot, unless the projectile can be removed.
- **Stock:** The part of a rifle or other firearm, to which the barrel and firing mechanism are attached, that is held against one's shoulder when firing the gun. The stock provides a means for the shooter to firmly support the device and easily aim it.
- **Trigger:** A mechanism that actuates the firing sequence of a firearm. Triggers almost universally consist of levers or buttons actuated by the index finger.

Safety And Handling

Gun safety is a collection of rules and recommendations that can be applied when possessing, storing, or handling firearms. The purpose of gun safety is to eliminate or minimize the risks of unintentional death, injury or damage caused by improper possession, storage, or handling of firearms. Therefore, four major rules have been universally recognized. Handle firearms with these principles In mind:

1. All guns are always loaded. Even if it is not, it should be handled as such.
2. Never let the muzzle cover anything you are not willing to destroy.
3. Keep your finger off the trigger until your sights are on the target.
4. Be sure of your target and what is beyond or behind it.

Remember to maintain the firearm. It must be cleaned and lubricated before any battle or attack for ideal performance. Learn how to field strip and reassemble your firearm. You should be quick at doing so. Consult the resources that come with the firearm for proper field stripping. Every firearm is different.

The sight picture is the pattern of your gun's sights in relation to your target. When you're aiming a gun, you're looking at three objects: the front sight, the rear sight, and your target. However, it's not possible to focus simultaneously on all three objects. One of the objects will inevitably be blurry when you're aiming. When you have a correct sight picture, your front and rear sight appears sharp and clear and your target appears to be a bit blurry. Here is how the aiming should look:

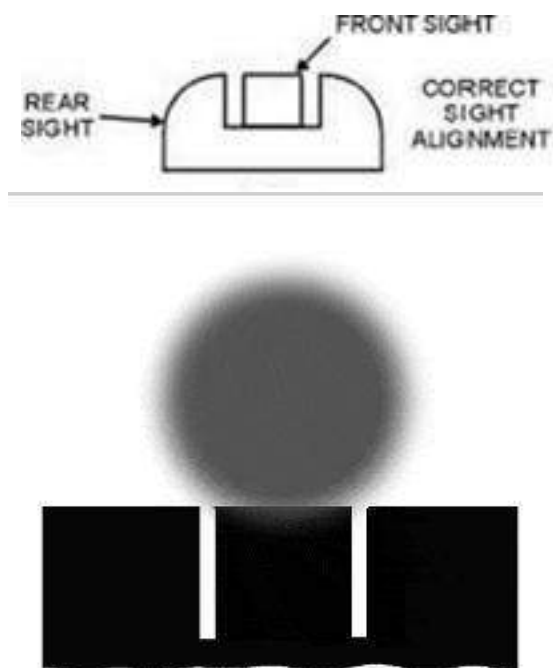

Cleaning

Cleaning and maintaining your guns preserves their functionality and value, and keeps them safe and accurate. The effort and attention you put into maintaining your firearms will pay off in peace of mind that your guns will do what you need them to do. Good maintenance habits help you know your gun better, and have more confidence in its performance at the range or in the field.

Preparation is key to a good job. Choose a work area that is well-ventilated, well-lit, organized and clean. Outdoors or in the garage is best. If you must work indoors, choose a large indoor room, and try to work near an open window. Your work table should be sturdy. It shouldn't rock or move when you lean on it. Avoid tables with wheels or casters. The dining room table or the kitchen counter is not the best choice, because you don't want to contaminate your food with chemical solvents, gun oil copper, lead or carbon fouling. For the same reason, you shouldn't eat or drink while you work.

Once you have chosen an appropriate work space, remove all ammunition from the area. All loose and boxed ammunition should be returned to its proper storage place before you start. Only after that is done should you get out your gun and make sure that it is clear. If the gun has extra magazines, make sure they are empty as well. Before you get to work, find the owner's manual from the manufacturer. It should explain how to take the gun apart and clean it.

There are a variety of specialized and improvised tools that will help you get the job done right, but can't be found in any cleaning kit. A rubber mat with a non-slip surface will help protect both the parts and the work bench from damage. A cleaning cradle keeps the gun under control and leaves your hands free to control loose parts and cleaning equipment. If you don't have one, a shooting rest for sighting-in or varmint shooting is better than nothing. Your bench vise may look tempting, but leave it alone: Too much pressure from the vise can crack the stock or even crush the receiver.

Also, an old cookie tin or coffee can is useful for holding loose parts. A container helps keep them in one place so small parts won't get lost or separated. You might want two: one for dirty parts waiting to be cleaned, and a second for parts that have already been cleaned. Lastly, here's a trick for when springs or pins go flying: Keep a flashlight on hand, as it is often a big help in finding lost parts. Even the tiniest pins and springs that have fallen on the floor will cast a shadow when a beam of light passes over them. Once you have the gun disassembled, start with cleaning the bore. The rifling at the muzzle is critical to accuracy. You don't want the cleaning rod to bang against the muzzle opening. Over time, this can widen the muzzle opening or leave it misshapen, so clean from breech to muzzle whenever possible.

With some guns the barrel is more or less permanently attached to the receiver, which leaves you with no choice but to clean the bore from the muzzle end. In that case use a bore guide (a sleeve that protects the muzzle), or a bore snake, rather than a rigid cleaning rod.

Use a cleaning rod of the correct diameter. They generally come in .22-cal., .30-cal. Or shotgun/muzzle-loader diameters. A cleaning rod that is too big will get stuck in the bore, while a cleaning rod that is too small will tend to flex in the bore and it will take too much effort to push it through. One clue is that bore brushes are sized to the diameter bore and will only thread onto a cleaning rod of the proper diameter.

Start with wet patches to loosen the fouling. Bore solvents are usually meant for either copper fouling or lead fouling. Naturally, if you have been shooting jacketed or copper-plated bullets, use a copper solvent. If you have been shooting unjacketed lead, choose a lead solvent. I prefer cotton patches because they are more absorbent than nylon patches. Spear the patch on a jag or thread it through a loop before you wet it with solvent. In my experience, jags produce better surface contact, but they can be harder to push through the bore. Try to push the patch all the way through the bore in one smooth motion. Don't scrub, change direction or pull the dirty patch back through the bore. Always remove the dirty patch from the rod when it exits the bore. After you've run three patches through the bore, it should be ready for the bore brush.



Rifle with cleaning items around it.

Bore brushes should be matched to the diameter of the bore. They are available with nylon, bronze or steel bristles. Steel brushes are more rigid and abrasive and should be used with care and reserved for the toughest jobs. Nylon is the gentlest material, but it can take a lot more work to clean a bore with a nylon brush. In my experience, bronze brushes are the right choice for most cleaning jobs. Thread the brush to the cleaning rod and wet the bore brush with solvent. Once again, push the rod through in one smooth stroke and remove the brush after it exits the bore. Ten passes with the brush should be enough. Run three more wet patches through the bore to pick up the fouling loosened by the bore brush. Wipe down the cleaning rod before finishing up with dry patches. Each successive dry patch should come out of the bore cleaner than the last. If you don't see visible improvement after five to seven dry patches, repeat the process-starting with the wet patches-from the beginning.

Your next step depends on your shooting plans. Once you are satisfied that the bore is clean, you can leave the bore dry if you are going to shoot the same day. However, if you have to store the gun overnight or for a longer period of time, you will need to protect the bore from rust. Run a patch soaked with oil down the bore. Beware: Oil in the bore can create excessive pressure, a dangerous condition. Oil must be swabbed out before you shoot again, so get in the habit of running a dry patch down the bore before you take your gun to the range or the field.

Old toothbrushes, rags and cotton swabs are all useful aids for cleaning the rest of the gun. A general-purpose cleaner like Break Free or a carbon solvent will help loosen built-up powder fouling in the action. Once you are happy with your work, reassemble the gun right away. The longer the gun is left disassembled, the greater the chance parts will be lost or broken.

After you have reassembled the gun, it's time to make sure all of the parts work properly. Check the safety and the trigger for proper function. When you are satisfied that everything is in working order, you should oil down the exterior metal surfaces of the gun, because sweat and body oil from your hands can activate rust. Don't overdo it; a light coating of oil is enough. Be aware that gun oil can soften the wood, so don't soak the joints between the action and the stock.

Cleaning your guns is part of responsible and safe gun handling. Clean firearms are safer, more accurate and more reliable. The better you know your gun, the better you can diagnose accuracy and function problems, which makes you more confident at the range and in the field.

Handguns

We will be looking at the handgun. The first thing to know about handguns is that they all differ in their own unique ways. The main differences are in the operations of the safety lever, magazine release, and disassembly. For basic training, we have chosen the Russian Makarov. We will be looking at how to properly hold it and employ the stances.

Properly holding the gun can be the difference between accuracy and inaccuracy. Your grip hand should be directly underneath the end of the gun to prevent further recoil. If you have a small handgun like ours, grip the gun with your main hand. With the supporting hand, place your thumb over the other thumb and wrap the rest of your fingers above the

main hand. If you have a larger handgun, it's best to place a part of the supporting hand underneath the gun's magazine and the rest wrapped over the main hand.



When you are down to the last bullet, the base will pull back and will not move forward until you press the latch down. The base pulling back indicates to you to get the next magazine ready.

As shown in the figures above, the shooter employs both the straight arm technique, giving more control over the recoil, and the dropped arm technique, allowing more mobility in the shooter's movement. With the latter technique, make sure your support arm is bent and main arm is completely straight. To aim, lean your head against your main arm's shoulder.

Down or up? Special forces around the world have their own styles when it comes to walking with a gun. The Americans for example, when with the handgun, tend to have the gun pointed down while walking. Some prefer it to be pointing up. Another effective method is to walk with it pointing straight ahead.

When shooting, don't let the sound of the gun or recoil make you twitch. Try to be as stable as possible to ensure maximum accuracy. Try getting used to shooting as fast as possible at a target without looking down the sights. Sometimes in a gun battle, there will be no time to aim down the sights.

In the images to the right, you will find the various shooting stances that you can employ in a gun fight. In urban warfare, there are an endless amount of stances. These can be learnt from any handgun training video or website.



As seen in the fifth image, shooting sideways has a greater likelihood of being safe since less of your body is exposed. But you'll be trading safety for accuracy, as you won't have both of your arms to operate the handgun.

Handguns may jam when used, especially if the model is dysfunctional, not properly cleaned, or not properly used by the shooter. There is an easy method that can clear almost all jams regarding handguns: 'tap, rack, bang'. Your handgun has jammed! First you tap the magazine upwards to ensure that it is well-placed, and then you rack the handgun and eject the failed round. Sometimes, the round will be visible and look like you could drag it out by hand. This is called a stovepipe, and don't remove it with your fingers. The tap, rack, bang method is much more effective at removing stovepipes. For double feeds, this method will not work. A method to clear these jams is to take out the magazine, and then rack the handgun ~5 times, in case 2 rounds got chambered at once. And then there are issues like squib loads and hang fire that will require much more complicated procedures too lengthy to execute during a battle.

Shotguns

Note: The face of the man holding the shotgun has been censored in this document since they partook in none of its making. I might be encouraging dangerous activities, but I'm not a total asshole.

Shotguns are fired from the shoulder and are typically used to hit targets at short distances. Unlike rifle and handgun cartridges that can only fire a single projectile, a shotgun cartridge typically fires multiple pellets called "shot" that spread out as they leave the shotgun's barrel. Because the power of a single cartridge charge is divided among multiple pieces of shot, the energy of the shot decreases greatly as it travels away from the gun. That's why shotguns are short-range weapons.

Pump-action shotguns. A pump-action shotgun is a single-barrel shotgun that holds multiple rounds (unlike break-action shotguns). The way you extract spent shells and chamber a fresh round is by pulling a pump handle towards yourself, and then pushing it back into its original position along the barrel. Pump-action shotguns are widely used by police forces around the world because of their reliability and ability to hold multiple rounds. The Remington 870 has been the standby shotgun for American police forces for years, while the U.S. military has been partial to the Mossberg 500. Another good (yet cheap) pump-action shotgun is the Maverick 88.

They're relatively easy to use, nearly impossible to break, and are super reliable. More importantly, the sound of chambering a hot round into a pump-action 12 gauge is sure to soil the britches of even the most hardened criminal. As an added bonus, they're relatively cheap, with prices beginning around \$200.

One of the things you have to watch out for when firing a pump-action shotgun is short-stroking. That's when you don't push the pump all the way back to its original position, resulting in a failure to chamber the next round in the magazine.

Semi-automatic shotguns. A semi-automatic shotgun fires a single shell each time the trigger is pulled, automatically ejects the spent shell, and automatically chambers a new shell from a magazine. This allows you to fire off shots quickly. Some states ban hunting

with semi-automatic shotguns, so be aware of that if you plan on using your gun to hunt. The Mossberg 930 SPX is a good example of a semi-automatic shotgun.

Because rounds are automatically loaded and the design is more complex, semi-automatic shotguns are more prone to jamming failures than pump-action or break-action shotguns.

Shotgun ammo is broken down into three categories: birdshot, buckshot, and slugs.

Birdshot. Birdshot is smaller than buckshot and is used primarily for hunting, you guessed it, birds. Birdshot size is categorized by a number: the larger the number, the smaller the shot. The smallest birdshot is #12 shot and the largest is size FF. All birdshot pellets have a diameter smaller than 5 mm. Birdshot is so small it's simply poured into a shotgun shell until the shell reaches a certain weight.

Buckshot. Buckshot is typically used for hunting small to medium-sized game and for police and home defense purposes. As with birdshot, the buckshot is categorized by a number that decreases as the size of the shot goes up. The smallest buckshot is #4 and from there the sizes go past #1 to 0000 (quad-ought), 000 (triple-ought), 00 (double-ought), and 0 (ought). Unlike birdshot, buckshot is too large to be poured into a cartridge. Rather, the buckshot pellets are stacked into the shell in a fixed geometric arrangement in order to fit.

Slugs. Slugs are basically a giant bullet. Instead of firing multiple pellets, a shotgun shell with a slug in it only fires a single slug. Slugs are primarily used to hunt large game and for military and police purposes. Slugs are rifled which gives them spin as they leave the barrel of the gun, making the slug much more accurate and stable in flight.

Unlike handguns and rifles that use caliber to measure the diameter of the barrel, shotguns use gauge. Measuring gauge goes back to the days of muzzle-loading guns. A shotgun's gauge number is determined by the number of lead balls that are the size of the gun bore's diameter that can roll down the gun's barrel to make a pound. So for example, in a 12 gauge shotgun, twelve lead balls with a diameter equal to the diameter of the barrel adds up to one pound.

Confused? Don't worry. It takes a bit to wrap your head around it. Just remember this: The smaller the shotgun gauge number, the larger the barrel; the larger the barrel, the bigger the boom from your boomstick.

The most common shotgun gauge sizes are: 10 gauge = .775 inch, 12 gauge = .729 inch, 16 gauge = .662 inch, 20 gauge = .615 inch, 28 gauge = .550 inch.

In addition to a shotgun's gauge number, another size you'll see stamped on a shotgun's barrel is the chamber length. The chamber is where the shell fits into the gun for firing. You need to make sure the length of the shell you're loading into your gun matches the chamber length on your shotgun. Firing shells that are longer than the length of the chamber can generate dangerously high pressures in your gun. That's a big safety risk.

Now that we're familiar with the anatomy and workings of a shotgun, let's get down to how to fire it. There are multiple stances that can be taken when shooting the shotgun. The two

we will mention are the athletic stance and the close quarters stance. The athletic stance will almost always be used.

Square your shoulders up with the target. Stand with your feet shoulder-width apart on a straight line. Stagger your strong-side foot about six inches behind your weak-side foot. Place the buttstock of the shotgun near the centerline of the body and high up on the chest. Keep your elbows down.

The biggest advantage of the athletic stance over the bladed stance (standing sideways) is that it helps in reducing the effects of recoil when firing a shotgun. Think about it. If you're a lineman in football and you want to resist the other guy pushing you backwards, what stance would give you more balance? Being squared up with the other guy, or standing sideways with just one of your shoulders towards him? Squared up, of course. Another advantage of the athletic stance is that it allows you to track a moving target better.



The athletic stance.

The act of putting a shotgun to your shoulder is called mounting the gun. But you don't bring the gun to your shoulder straight off. You want to bring the side of the stock to your cheek first, before moving the buttstock to your shoulder.

Keeping your head up, bring the shotgun to your head. Press your cheek firmly to the side of the stock and then place the buttstock of the shotgun near the centerline of the body and high up on the chest, like so:

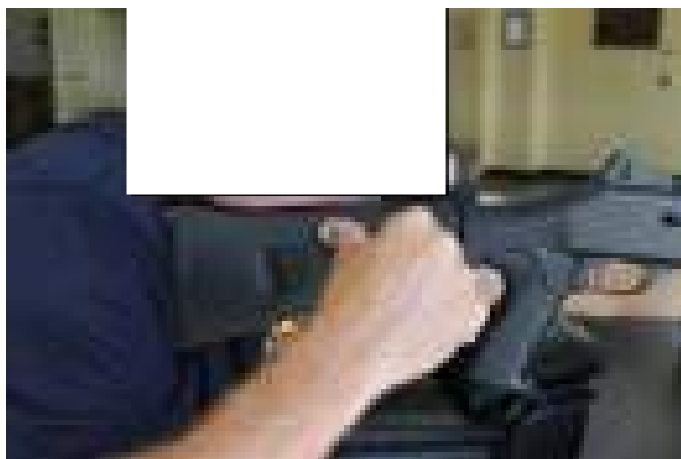

On most shotguns you'll find a crook between the stock and the trigger guard. Simply center the crook in the "V" junction of your thumb and index finger of your trigger hand. Grip the gun firmly, but not tightly.

If your shotgun has a pistol grip like our gun in the picture below, center the grip in the "V" at the junction of the thumb and index finger of your trigger hand. Grip the gun high on the backstrap (the backstrap is the back of the grip on the gun). Like so:

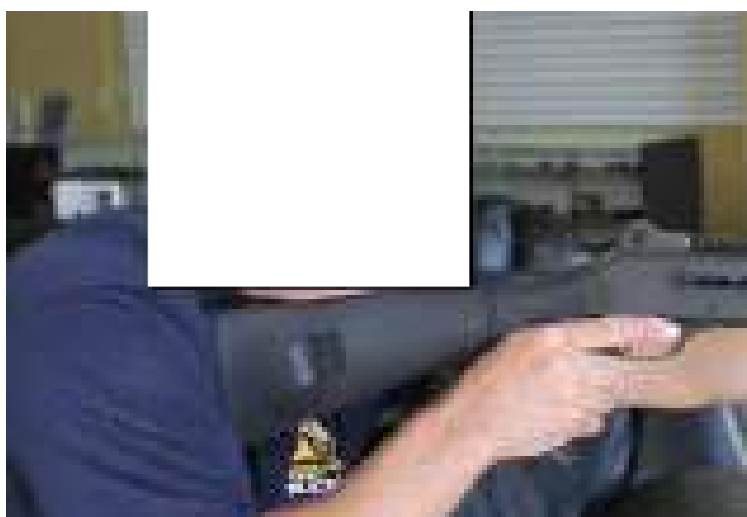

The support hand should grip the fore-end of the shotgun roughly midway down the length of the shotgun. Here's a demonstration for us:



Putting your support hand further forward on the fore-end will give you finer control over the muzzle when aiming, which you want when precision is key. It will also give you more leverage against the gun which helps in recoil control.

You've probably seen movies where the action hero fires a shotgun in close quarters from the hip. "That's a great technique...for the movies." If your target is really close to you, bringing the shotgun stock beneath your armpit in order to create more space between you and your target while maintaining more control could be viable. Here's how it looks:



The close quarters stance.

There's a lot of debate among shotgunners about how you're supposed to aim these things. You'll hear many folks say, "You don't aim a shotgun, you point it." Others will say you should aim it just like you would a rifle. You're responsible for every shot you fire, so you better be sure you know where they're going. Don't just point it and start firing action movie style. You'll want to aim your shotgun just like you would when firing a rifle. Some shotguns have a rear sight notch and a bead at the end of the gun's barrel (most shotguns don't have a rear sight). Align those just as you would with a rifle. After you have proper sight alignment, you'll want to set your sight picture.

Unlike with a rifle or handgun where you slowly squeeze the trigger, with a shotgun you can use a more direct and less controlled trigger press. Again, when firing a shotgun, speed in getting off a shot is the goal.

The pump-action shotgun is arguably one of the most reliable repeating firearms you can buy, it's not infallible. The number 1 cause for malfunctions with this gun is failure to port the action with purpose. This can cause stovepipes and double-feeds.

To clear a stovepipe, point the ejection port downwards and pumping the action. To clear a double-feed, put the gun on its back, apply pressure to the carrier (the plate in the place where you load the shells), and pump the action. One shell will be ejected. Sometimes,

shotgun shells will be placed backwards into the gun. If this is spotted early, there is still a chance. Put the gun on its back, press release, pull the action back to about 80%, reach inside with your finger, push the shell into the magazine and push the carrier down. Reach up and push the shell latches and free the shell.

Rifles

Note: The face of the man holding the rifle has been censored in this document due to the same reasons as in the shotgun section.

Rifles are high powered firearms typically used to hit targets at long distances. Rifles are designed to be fired from the shoulder. Grooves, called rifling (hence the name rifle), are cut into the barrel of a rifle. Rifling makes the bullet spin as it leaves the muzzle, making the bullet much more accurate and stable in flight. Some good rifle calibers for the guerrilla are 7.62mm (.308 Winchester) and 5.56mm (.223).

There are two common stances when firing a rifle: bladed-off and a squared, 'athletic stance.'

Bladed-off stance. A bladed stance is when your weak-side shoulder is facing the target. So if you're right handed, your left shoulder is facing the target; if you're left handed, your right shoulder faces the target. It sort of looks like how a baseball batter would stand in the batter's box.

Many first-time shooters stand in a bladed-off stance when firing a rifle. They probably saw their favorite cowboys or action heroes in movies take this stance, so they assume it's the best way to stand. While a bladed stance is good for competition shooters who need precision in their aim, it's not a great stance for shooters in more tactical situations that require rapid shots with minimal muzzle rise.

Squared or athletic stance. The folks at our academy teach their students to assume an athletic stance when firing a rifle. Square your shoulders up with the target. Stand with your feet shoulder-width apart on a straight line. Stagger your strong side foot about six inches behind your weak side foot. Place the buttstock of the rifle near the centerline of the body and high up on the chest. Keep your elbows down.

The biggest advantage of the athletic stance over the bladed stance is that it helps in reducing the effects of recoil when firing a rifle. Think about it. If you're a lineman in football and you want to resist the other guy pushing you backwards, what stance would give you more balance? Being squared up with the other guy or standing sideways with just one of your shoulders towards him? Squared up, of course.

Another advantage the athletic stance has over the bladed stance is that the athletic stance allows you to track a moving target better. A bladed stance limits how much you can twist your body. An athletic stance allows you to swivel right or left much more easily.



The bladed-off stance.



The athletic stance.

Now how to hold a rifle.

Rifle with pistol grip. If your rifle has a pistol grip, like the AR-15 or JP-15, center the grip in the “V” at the junction of the thumb and index finger of your trigger hand. Grip the gun high on the back strap (the back strap is the back of the grip on the gun).



Rifle without a pistol grip. Most bolt action rifles don't have a pistol grip like the AR-15. What they typically have instead is a crook between the stock and the trigger guard. With these sorts of rifles, center the nook in the “V” at the junction of the thumb and index finger of your trigger hand. Grip the gun high on the nook.



The support hand should grip the forestock (or handguards if you're shooting an AR-15) of the rifle roughly midway down the length of the rifle.



The support hand is gripping the handguards.

Putting your support hand further forward on the forestock will give you finer control over the muzzle when aiming, which you want when precision is key. The disadvantage of putting your support so far out on the forestock is that it's a little less stable.

Bring the rifle to your head and press your cheek firmly into the stock. Keeping your head up, bring the rifle to your head. Place the buttstock of the rifle near the centerline of the body and high up on the chest. Press your cheek firmly to the side of the stock of the gun.

To fire a gun, we often use the popular phrase "pull the trigger." However, to fire a gun properly, you don't actually want to pull the trigger, but rather press it in a controlled fashion so you don't disrupt your sights. Managing the trigger on a rifle is similar to doing so on a handgun.

1. Press, don't pull. Instead of pulling the trigger, press (or like my dad likes to say "squeeze") the trigger straight to the rear. Apply constant, increasing reward pressure on the trigger until the weapon fires. Ensure that you're only applying pressure to the front of the trigger and not the sides.
2. Take the slack out of the trigger. Squeeze the trigger to the point you start feeling resistance.

There are numerous shooting aids on the market today from monopods to tripods to sandbags and complete gun cradles designed to be packed into the blind. Some products are gimmicks, and some are a boon to shooters, but none replace the fine art of learning the fundamentals of field position shooting from the standard four positions. The four basic "competition" rifle shooting positions are prone, sitting, kneeling, and standing (also called "offhand"). These are in order of steadiness; generally speaking, the closer you can get to the ground, the steadier you are.

An awful lot of years have passed since I used these positions in either competition or military qualification, and of course, many of us have never used them in either. On the other hand, I have used all of these positions in the field. As we'll see, absent competitive

rules or screaming drill instructors, all of these positions can be endlessly modified for field use.

Prone is simply lying down behind the rifle. I will invariably use a hasty sling, but the basics are easy. Both elbows should be solidly grounded, with the supporting elbow directly under the rifle. The rest of it depends on what works for you. The classic prone has the body at an angle (left for righties, right for lefties). The more modern prone has the body more directly behind the rifle with your strong side leg slightly bent.



At the range (or in your backyard with an absolutely safe weapon) start from a standing position and pick out your target. Wrap your arm into the hasty sling and drop down into prone, sighting at the target. Close your eyes. When you open them you should still be aiming at the target. If you aren't, then your position is off. A good coach would walk down the line and firmly kick each muzzle. If the shooter's sight picture returns after the kick, then body alignment is good. If not, adjustment is needed.

The good old prone is great, but if you start with a good, solid body position and then support the fore-end on a pack, bipod, or whatever else, then you can achieve very near to benchrest stability.



Two comments. First, when I'm prone but the fore-end is rested steadily, I actually revert to benchrest technique with my supporting hand. Instead of keeping my hand on the fore-end, I use it to snug the butt into my shoulder. This may not work for you, but it's worth trying.

Prone is the steadiest by far and easiest to master, but it will probably be the least-used in the field because, all too often, vegetation gets in the way and obscures the view. So you have to get higher.

A proper **sitting** position is extremely difficult to master, and to do it right, you have to be fairly limber. The steadiest sitting position is with crossed legs, body about 45 degrees to the target, ankles flat to the ground. As with everything else, sling tension really helps.



Here's where it gets tricky. Ideally, you bend forward from the waist and rest your elbows over your knees, not on top of them. I freely admit that this is getting a bit more difficult. The alternative, which is faster and easier to assume (especially if you have — horrors — a bit of middle-aged paunch), is with the knees up, feet flat on the ground, legs spread about 45 degrees. This is not as steady, but you don't have to be quite as much of a contortionist!

Done properly, the sights are in perfect alignment on the target, and the shooting hand is really doing nothing other than gently holding the pistol grip and steadily squeezing the trigger. The test for correct body position is the same as prone. Ensuring you have a completely empty and safe rifle, get into your best sitting position and aim in at the target. Have someone push the rifle rearward, as if in recoil. You should come back right on target. If you don't, you probably need to scoot your butt a bit one way or the other and change the angle.

All positions are strengthened through the use of a "hasty sling." The sling is used to create isometric pressure to increase steadiness. The formal "tight sling" is actually detached from the rear sling swivel and tightened above the bicep of the supporting arm.

Using the now-rare two-claw sling, I have actually done this in the field for tricky shots in both prone



and sitting. This is almost a lost art today, and most rifle slings (really, carrying straps) don't allow it. That's OK. Almost any carrying strap can be used in the "hasty sling" mode. The steadiness achieved is almost as good as a tight competition sling — and it's a whole lot faster.

Here's how. With the sling loose enough for shoulder carry, hold the rifle with your shooting hand and thrust your supporting hand and arm between rifle and sling. Then wrap your wrist around the sling once. Right-handers, with a left supporting arm, wrap clockwise. Left-handers, with a right supporting arm, wrap counter-clockwise. Bring your supporting hand to the fore-end, usually just behind the sling swivel, and assume your position. The sling tightens across your body, and you'll be amazed how much additional steadiness this gives you.

There is often a compromise between the most comfortable "carry" length for your sling and the ideal tension for a hasty sling. I keep mine adjusted for the hasty sling!

The kneeling position is not nearly as steady as sitting; but it's a lot faster and beats the heck out of standing. Getting into position is a simple matter of assuming the hasty sling and dropping into position, weak-side knee and foot pointing at the target, supporting elbow over the knee — not directly on top (because it can slip).



Strong-side leg is out at about 90 degrees, knee on the ground. Depending again on how limber you are, you are either sitting on that foot, with the foot flat, or sitting on the heel with the toes grounded.

In kneeling the shooting hand is pulling the stock into the shoulder, but the primary support should come from the sling and the supporting arm.

The best form is probably to have the shooting elbow out horizontally, but, hey, we're shooting game, not winning Olympic medals. So practice, see what works, and then practice some more until you can drop to one knee fast!

The kneeling position gets you a bit higher than sitting, which can be important, but it's really at its best for times when you need to shoot quickly, but it's a bit too far (or you're breathing a bit too hard) to risk a shot from the standing position.

All of these positions need practice, but once you get the hang of it you should be able to drop into a kneeling position almost instantly.

Common Firearms

Here are some common firearms the guerrilla may use.

Glock

Polymer-framed, short recoil-operated, locked-breech semi-automatic pistols designed and produced by Austrian manufacturer Glock Ges.m.b.H. Relatively cheap and very reliable. Supplied to national armed forces, security agencies, and police forces in at least 48 countries.

There are models of the Glock suited for 9mm Parabellum, 10mm Auto, .45 ACP, .40 S&W, .380 ACP, .357 SIG, .45 GAP, .22 LR and .50 GI. For our purposes, 9mm Parabellum is ideal due to its power and wide availability. The Glock 17 Gen 4 and Gen 5 (9mm Parabellum), 19 Gen 5 (9mm Parabellum), 20 Gen 4 and SF (10mm auto), 21 Gen 4 and SF (.45 auto), 41 Gen 4 (9mm Parabellum), and 40 Gen 4 (10mm auto) are all powerful handguns that can be used. However, the Glock may have to be concealed at times, and then it must be smaller and more compact. Models that fit that those requirements include Glock 43 (9mm Parabellum), 43X (9mm Parabellum), 48 (9mm Parabellum), 36 (.45 auto), and 42 (.380 auto). While less effective than their larger counterparts, they can be well concealed to attack the target with maximum surprise or to surprise the attacker.



Glock 17 "First-generation".

Glocks have been used as the main firearm mass-shooting operations such as the Charleston church shooting (9 killed, 1 injured) and the Enfurt school massacre (16(+1) killed, 1 injured).

Glocks have been used as the main firearm mass-shooting operations such as the Charleston church shooting (9 killed, 1 injured) and the Enfurt school massacre (16(+1) killed, 1 injured).

Links to Glock modern manuals: <https://us.glock.com/en/downloadable-materials>

Uzi

The Uzi (officially cased as UZI) is a family of Israeli open-bolt, blowback-operated sub-machine guns first designed by Major Uziel "Uzi" Gal in the late 1940s, shortly after the establishment of the State of Israel. It is one of the first weapons to incorporate a telescoping bolt design, which allows the magazine to be housed in the pistol grip for a shorter weapon.

It is illegal to acquire an automatic Uzi for most people. However, they are rather common in the armories of militant organizations and criminal gangs. Thus, it could be acquired from the black market. The best Uzi are the models chambered in 9mm Parabellum, as the ammunition is plentiful and 20-, 25-, 32-, 40-, or 50-round box magazines have been manufactured for the 9mm Uzi.



Uzi sub-machine gun.

Other information:

Effective firing range: 200 m.

Muzzle velocity: 400 m/s.

AK-47

Whichever land of war you decide to travel to today, the semi-automatic AK-47 rifle chambered for 7.62x39mm will be the standard weapon of choice among the guerrilla forces.

For those who are unfamiliar with the weapon, may think that it is one type; that is not true. You will find more than 20 different brands. The Kalashnikov is made in different countries; this gives the weapon a few variations. Some of the countries that manufacture the weapon are Russia, former East Germany, Romania, China, Poland, Bulgaria, Iran and Egypt. The Russian version is considered to be the most durable of the different brands and the East German one would be after that.

Let's say you are at the arms dealer and see all these different types of Kalashnikov's. You pick up one of them to see where it originates from but don't see the countries name etched anywhere on the rifle. Eventually you realize that none of them have their country names etched on the Kalashnikov. So how do you tell which one is which?

If you look at the side of the rifle carefully, usually in the middle, you will find some sort of logo. That logo will tell you where that gun is coming from. The table to the right will help you identify the rifle's origin and Figure 1.0 will show you where to look. We won't be going into the details of each rifle as that would prolong the series, so we will leave that up to the individual to do research on.

Bulgaria	10
Poland	11
Bulgaria	21
Bulgaria	25
RPC/China	36
RPC/China	66
RPC/China	386
East Germany/DDR	
East Germany/DDR	
Russia	
North Korea	
RPC/China	
RPC/China	
Romania	
Russia	
Russia	
Russia	
Russia	
Russia	
East Germany/DDR	K3

Figure 1.0.



Figure 1.0: The writing above is where you will find the information.

AR-15

The AR-15 (also known as the modern sporting rifle, and technically the AR-15 style rifle) is much more optimal than the AK-47 and is in fact much cheaper to buy legally in the USA, but is not as common elsewhere. It should cost around 450 dollars at least for a reliable model. Its ammunition is highly plentiful, it is easily modified, and it does not overheat as quickly as the AK-47. It is advised for the AR-15 to be made from parts bought separately for maximum optimizations. The AR-15 is most commonly chambered in .223.

There are many manufacturers for AR-15s. Constructing AR-15 will save lots of money compared to buying them whole, and spend the money on the more expensive high quality parts where it matters. The highest quality parts (you will have to be willing to spend some serious money for some of these) could be bought from manufacturers such as Noveske, LMT, Radian, Heckler & Koch, Daniel Defense, BCM, Colt, Larue, and Knight's Armament. Other manufacturers of fairly high quality are Spikes, Brownells, Anderson Manufacturing, Smith and Wesson, CMMG, Midwest Industries, RRA, and Delton. Always ensure there are no issues with the rifles and or rifle parts bought. Quality control issues are common when buying from cheaper manufacturers. Buy cheap good iron sights from Ruger and Magpul. Vortex, Primary Arms, and Holosun make cheap red dots.



AR-15 rifle showing its modifiable nature.

So you want to build an AR-15? Before you buy your first part, decide what kind of rifle you want. Will you be varmint hunting, plinking or competition shooting? Once you make this decision, you know what type of upper receiver and barrel you will use. The upper receiver and barrel you choose will determine the remaining parts needed. Here are several types of stripped upper receivers, each with different features for different applications. Now (as I wouldn't like these firearms taking lots of pages in this documents) here are some good resources for building and maintaining AR-15s:

- <https://www.midwayusa.com/how-to-guides/how-to-build-ar-15-rifle>
- <https://www.midwayusa.com/schematics/ar15>
- <https://www.instructables.com/How-to-Field-Strip-an-AR-15/>

AR-15s have been used as the main firearm mass-shooting operations such as the Christchurch mosque shootings (51 killed, 40 injured), the Parkland school shooting (17 killed, 17 injured) and the Sutherland Springs church shooting (26 killed, 22 injured).

Other information:

Effective firing range: 400-600 m.

Mini-14

Let's buy a Mini-14! First we will have to buy one that is of a better design to ensure the best operation possible. There will be two types of Mini-14 we will be talking about now: old (pre-580) and new (post-580). The important distinction comes from that in the mid-2000s all production of the Mini-14 series was stopped. The gun was given a long overdue makeover and put back in production on new tooling. 580 and 581 is a 3-digit serial number prefix indicating the gun was made after the redesign. Post-580 models are worth a lot more money, paying 650 dollars for a new one is a decent deal. Used 500-600 is ideal. Best caliber for a Mini-14 would be 5.56.

Used 180-189 series Minis have inferior quality control and accuracy. I wouldn't pay more than 400 dollars for one, barring it being a special version such as the bicentennial, a GB, or coming with a factory underfolder stock. Stainless models are a bit better, but they aren't worth much more nor are they rare. Also "Ranch Rifle" is a term they used ever since they added scope bases. It's still used to refer to standard minis as opposed to "tactical" and "target" versions. Really old minis were just "Mini-14"s.



Magazines are very important to be selected. Ruger magazines are ideal. Factory 20-round magazines can sell for 25 dollars new, and 30-round magazines can sell for 35

dollars. Spotting lying magazines is easy. All Ruger magazines have either the Ruger name on the metal or the logo on the baseplate. Sellers frequently pass off aftermarket mags for factory mags.



Factory magazines.



Aftermarket magazines.

Aftermarket magazines are notoriously dysfunctional. Avoid them.

Now on barrel struts. A good portion of the mini's accuracy problems come from the barrel flexing too much, especially when it gets hot. The solution? Add a chunk of metal from the gas block to the barrel to reinforce it.

The Mini-14 was used in the deadliest single-man firearms operation in history in 2011 by Anders Behring Breivik in Utøya, Norway. 67 were killed (+2 indirectly) and 66 injured.

FN FAL

The FAL is a battle rifle chambered in 7.62x51mm NATO designed by Belgian small arms designer Dieudonné Saive and manufactured by FN Herstal (or simply known as FN). It is one of the most widely used rifles in history, having been used by more than 90 countries mostly during the Cold War. It is commonly used by multiple revolutionary organizations, such as the Islamic State, Democratic Forces for the Liberation of Rwanda and the Lord's Resistance Army.



A standard FAL (50.00 model) produced by FN.

Dragunov

The Dragunov sniper rifle (also known as the SVD-63 or 6V1) is a semi-automatic designated marksman rifle chambered in 7.62×54mmR and developed in the Soviet Union. The Dragunov was designed as a squad support weapon since, according to Soviet and Soviet-derived military doctrines, long-range engagement ability was lost to ordinary troops when submachine guns and assault rifles (which are optimized for close-range and medium-range, rapid-fire combat) were adopted.

Since then, the Dragunov has become the standard squad support weapon of several countries, including those of the former Warsaw Pact. China produced an unlicensed copy of the SVD through reverse-engineered samples captured during the Sino-Vietnamese War as the Type 79 and 85. Iran also produced a clone, the Nakhjir 3, which was a direct copy of the Chinese Type 79.

The rifle is widely used by different revolutionary organizations such as the Taliban, Lord's Resistance Army and the Islamic State.



Dragunov sniper rifle with a sling attached.

RPG-7

Technically not a firearm but will still be included. The RPG-7 is a portable, reusable, unguided, shoulder-launched, anti-tank, rocket-propelled grenade launcher designed by the Soviet Union and now manufactured by the Russian company Bazalt.

The ruggedness, simplicity, low cost, and effectiveness of the RPG-7 has made it the most widely used anti-armor weapon in the world. Currently around 40 countries use the weapon; it is manufactured in several variants by nine countries. It is popular with irregular and guerrilla forces. The RPG has been used in almost all conflicts across all continents since the mid-1960s from the Vietnam War to the ongoing Syrian Civil War.



When firing the RPG-7, one will notice that there is no recoil. This is because similar to a recoilless rifle the RPG-7 has no noticeable recoil, the only effect during firing being that of the sudden lightness of the launcher as the rocket leaves the tube

An RPG-7 launcher (top) with a Bulgarian PG-7G inert training An RPG-7 launcher (top) with a Bulgarian PG-7G inert training warhead and booster (bottom).

Note: The guerrilla has many other options! The firearms listed are just some common ones in guerrilla warfare. Whatever firearm available can be used if the operation is planned appropriately for its limitations.

AR-15 To Automatic

Three things will have to be manufactured to convert a semi-automatic AR-15 to an automatic rifle. They require a milling machine. Converting firearms to automatic is illegal in the USA so securely cache the weapon.

Bolt carrier converter

The only difference between the AR-15 carrier and the M16 carrier is that the AR-15 has had the area that trips the auto-sear machined off. By manufacturing the bolt-on adapter shown in the drawings, the AR-15 bolt carrier can be adapted for use in a machinegun.

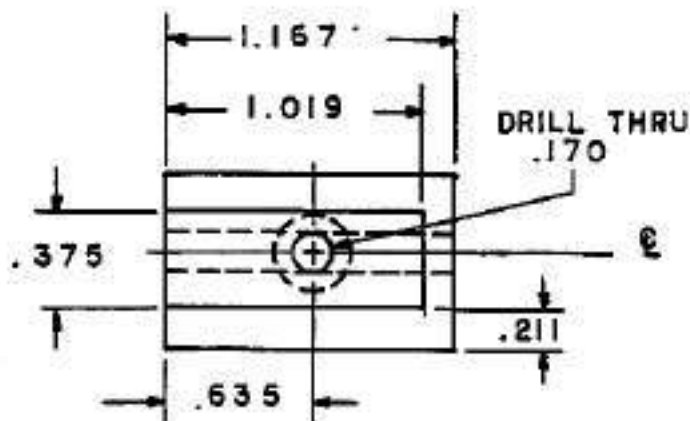

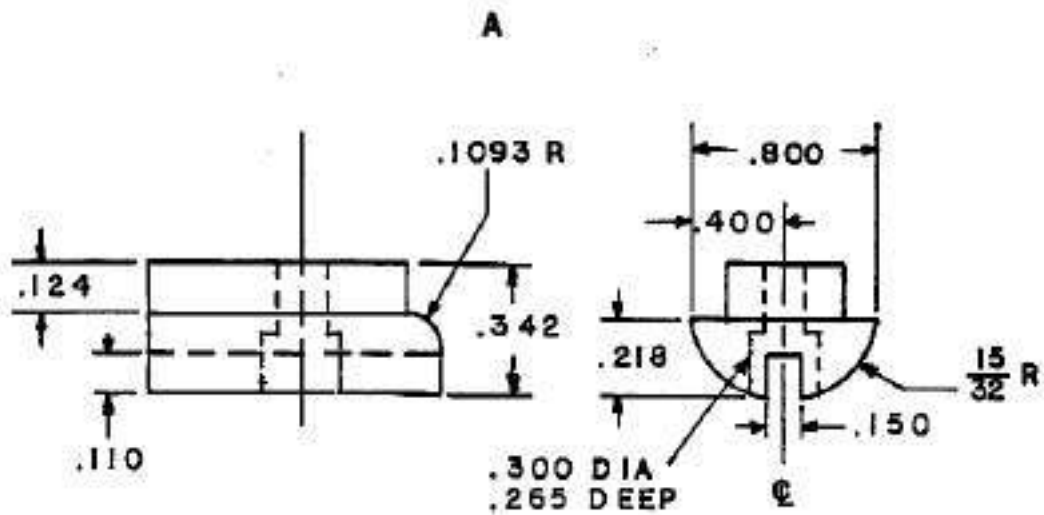

The carrier converter can be made from low carbon steel and case hardened using a product like Kasenit surface hardening compound. Complete hardening instructions come with Kasenit.

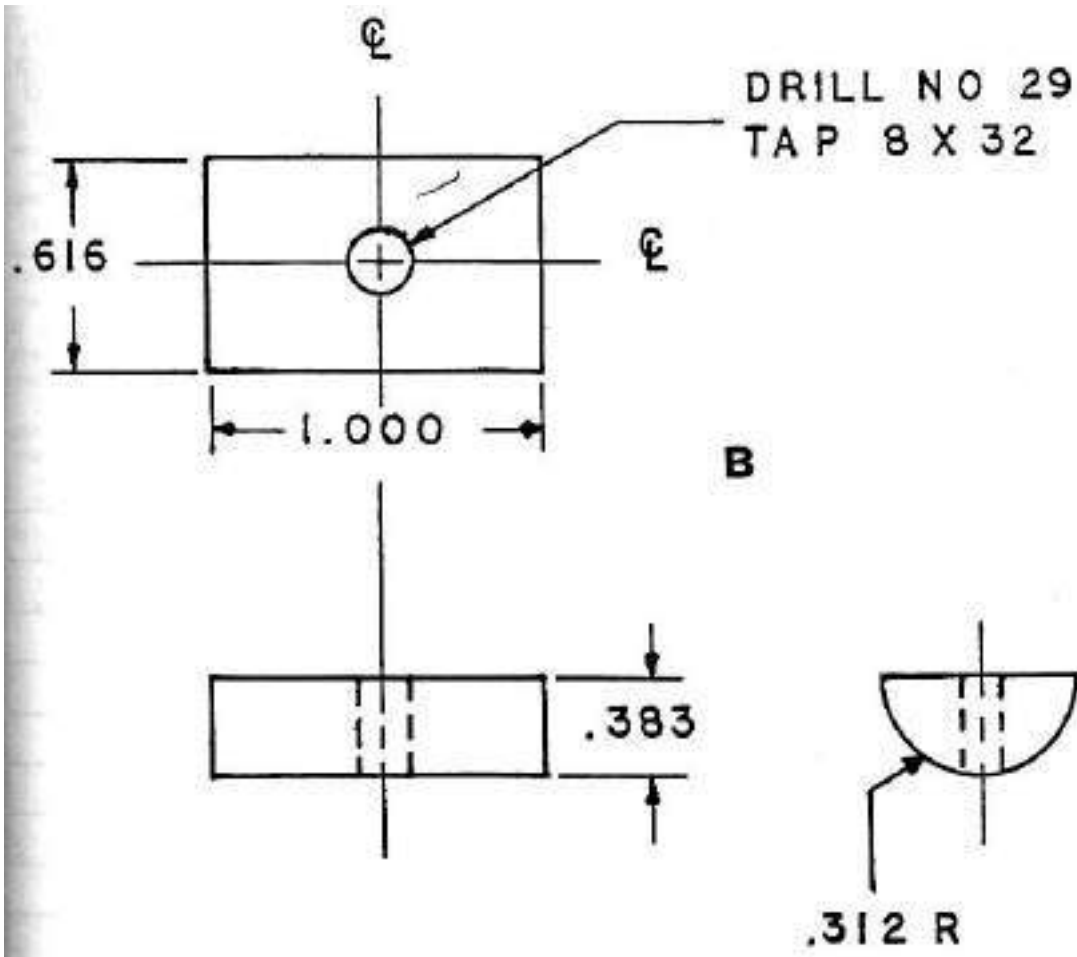

Part (B) first inside the bolt carrier. It acts as a nut. Part (A) is the trip. It fits at the bottom rear of the carrier. Use a 8 x 32 x 9/18 long hex head bolt to hold the parts together.

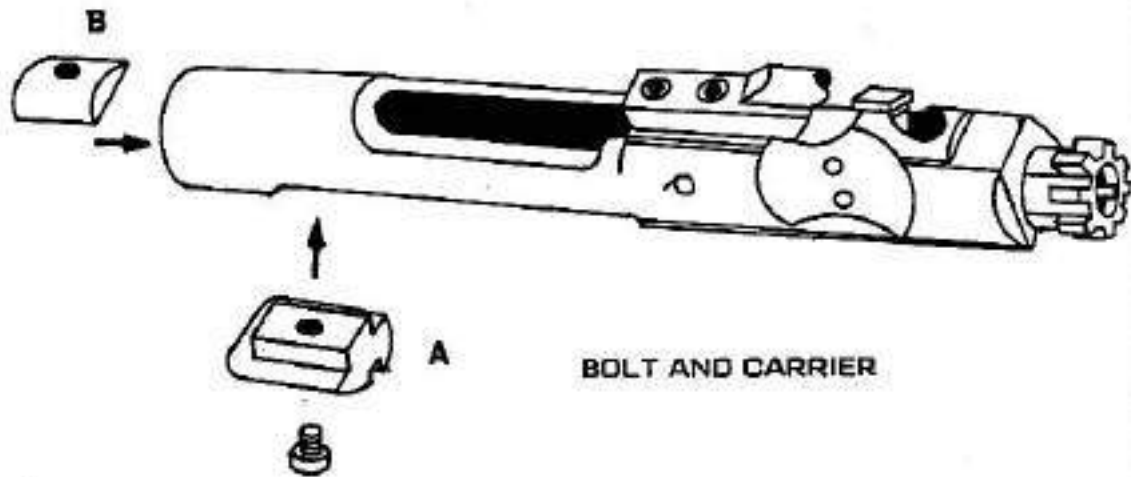

Drop-in auto-sear

The four parts of the drop-in auto-sear are a pretty straight-forward proposition. The sear housing can be made from either mild steel or aluminum. The housing bears very little stress so a hardened housing is not needed.

The sear trip is another story. This is the part of the drop-in sear that takes the beating. It not only catches the hammer in a cocked position, it also is struck with the full force of the bolt carrier each time the weapon cycles. Firing at a rate of 750 rounds a minute. It takes a real beating. It can be hardened by heating it with a bright cherry red with a torch and dropping it immediately into 10 wt. Motor oil. Do so outside. To temper the part after hardening, place it in your kitchen oven for one hour at 500 degrees Fahrenheit. Let it cool with the over door closed. Do not use a microwave.

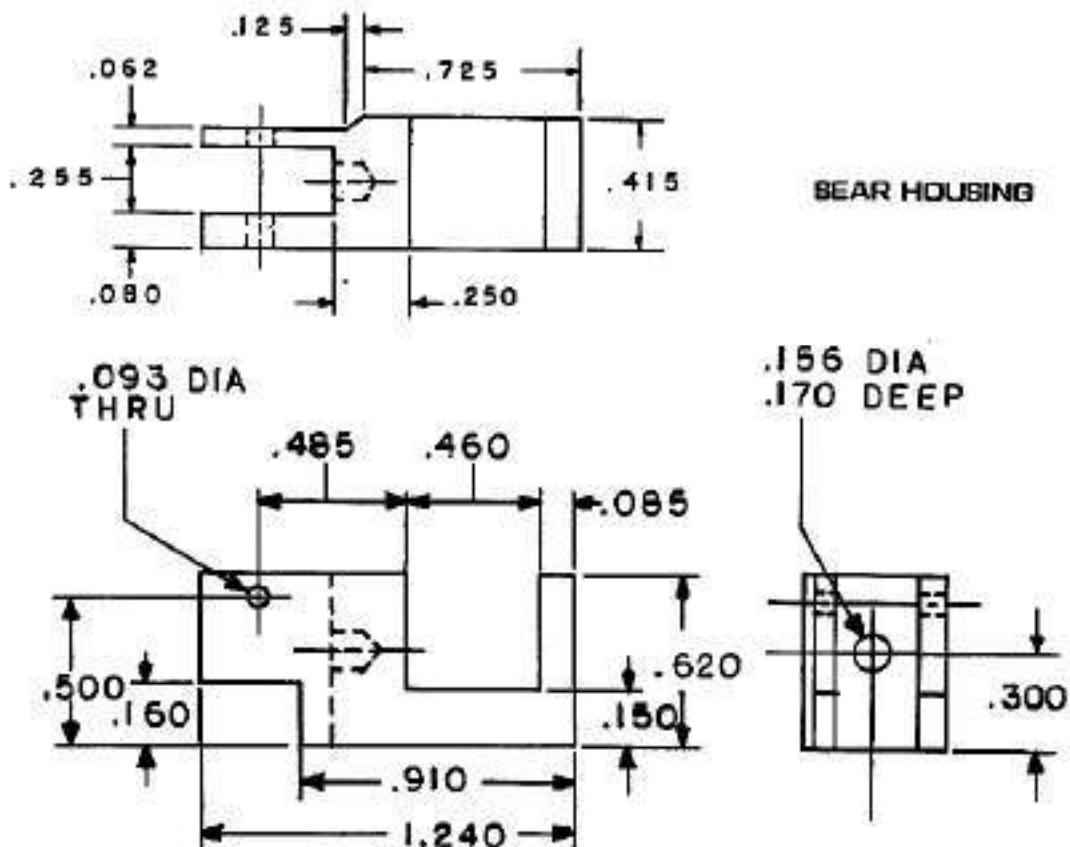

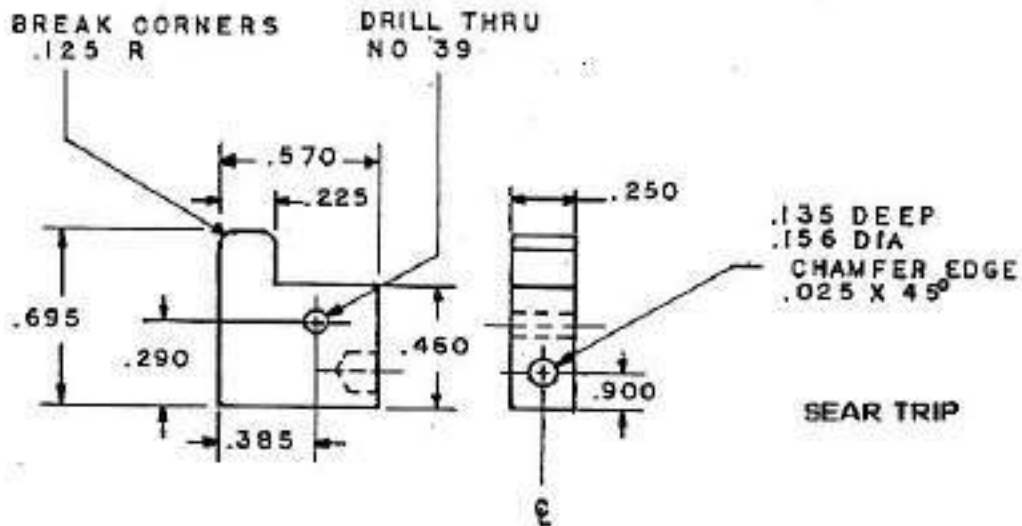

The spring is made form No. 18 wire. Wind it around a mandrel that has been turned on a lathe. You will have a spring exactly like the one shown in the drawing. OR: Find a hunk of spring that fits the hole at the front of the sear body without dragging, chop it off at the right length, and call it a job well done.



The trip pin can be made from drill rod stock. Although I find a roll pin works as well without the need for a precision fit in the sear housing. Whichever is used, make sure the trip rocks freely on the pin when it's assembled.

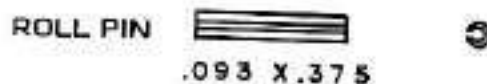

Lightning link

The parts can be made from tool steel, machined with great precision, hardened and tempered with loving care, then polished to a high gloss. On the other hand, using only a couple pieces of power hacksaw blade to make the parts from a dremel tool, hand drill and one or two files should do the work. You can cut out the lightning link in about an hour.

The drawings show the shape and give the dimensions for a lightning link that fits in the Colt AR-15. If it's to fit in an after market lower receiver it may be necessary to change the outside dimensions. All that's really important is that it fits inside the receiver and can move back and forth about 1/16 inch.

When building the lightning link without a milling machine I find the simplest way is to cut the long piece to length and width. Next center punch and drill a 1/8 inch hole at each corner of the large oblong hole at one end. With a dremel tool and bonded cutoff wheel cut out the material between the four holes you drilled.

Next center punch and drill a 1/8 inch hole so you can cut out the .130 wide tail that extends out of the oblong you have already cut. Do not square off the end of the .130 cut this time.

Center punch and drill a 1/32 inch hole at each end of the .043 slot at the other end of the part. Cut the slot out with the dremel tool and bonded cutoff wheel. Square the ends and finish the slot using a needle file.

Clean up the oblong hole and .130 wide cut with a small file. Now it's time to square the end of the .130 cut carefully. Don't get carried away. The distance between the front (squared end) of the .130 cut and the rear face of the .043 slot can not be more than 2.120.

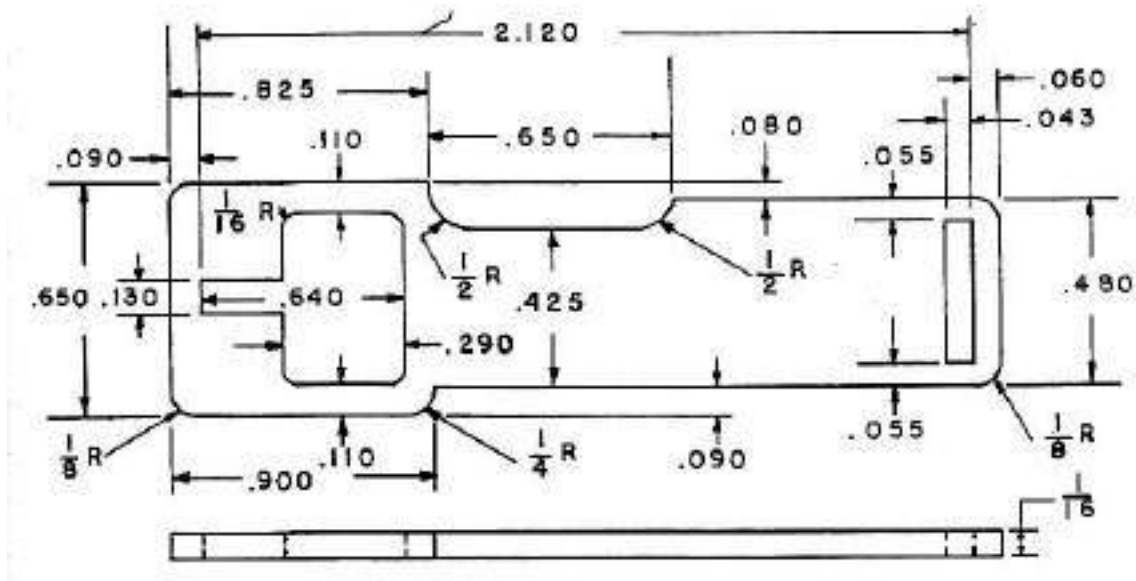

File or grind the outside edges to shape until it fits into the lower receiver without touching the inner receiver walls.

To check the link for fit and function, drop it over the hook on the disconnecter, refer to drawings (A) and (B). Hold the trigger back and cock the hammer. It will be caught by the disconnecter hook. Now place a scribe or anything that will fit into the slot at the rear of the link and pull it toward the back of the receiver. The hammer should fall. If it did, keep holding the trigger, recock the hammer and do it all again. As long you hold the trigger back, the link will release the hammer. When you release the trigger, the link can no longer release the hammer from the cocked position.

If the link would not move back far enough to pull the disconnecter hook of the hammer, find out what's stopping it and correct the problem.

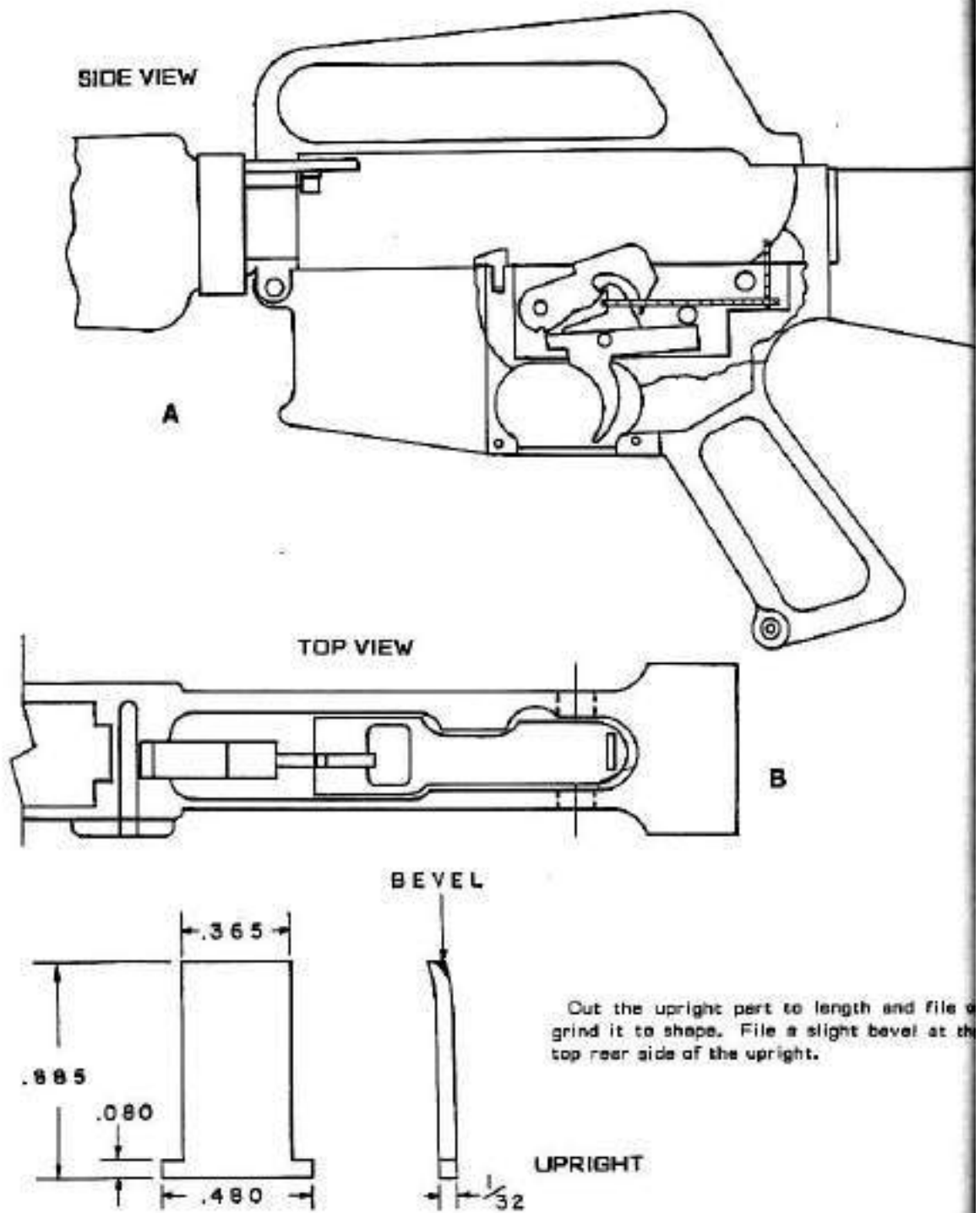

Assemble the parts. Install the parts in the lower receiver. Tip the weapon so the link's upright rests against the rear of the receiver. Close the upper until the take-down pin post is far enough into the lower receiver, that when you tip the firearms muzzle down the link's upright can rest against the post. Continue closing the weapon until it's completely closed. The first time you may have trouble getting the link upright to slide in place between the rear and take-down pin post and the bolt carrier. All I can tell you is wiggle and jiggle things until it goes in place.

After the take-down pin is in place, hold the trigger back and operate the bolt carrier about five times. The bend in the top of the links upright is formed at this time by the bolt carrier hitting it. Be sure to let the bolt slam with full force each time. Now's the time to find out if everything's working right. Cock the weapon, point it in a safe direction and pull the trigger. You should hear the hammer fall. Keep holding the trigger, cock the weapon, and release the trigger. Pull the trigger. Nothing will happen, the lightning link will have released the hammer when the bolt carrier closed.

GUNFIGHTS

A gunfight is quite similar to hand-to-hand combat, in the sense that there are skills & tactics to adopt to overcome your opponent. A gun is such a dangerous weapon; did you think just anyone can shoot one much more win a gunfight? Forget what Hollywood shows you: you don't believe that four teens without prior training would plan a bank robbery & come out victorious against 20+ trained police officers in a shootout. Do you?

Apart from the basic training you'll go through before handling a gun, there are special tips & strategies to ensure you win a gunfight, and these are what this article discusses. It's just like football. Everyone knows the basics are passing & shooting, but we also know there are special skill sets displayed by the extraordinary players. That's what we want to help you develop...

Keep a Delightful Little Sidearm Pistol Handy: Weapons fire; weapons stop. This is a fact taught to all soldiers in the first lessons of weapon training. You have to know this because real-life guns are very different from what you use in Call of Duty. Weapons can stop firing for many reasons. It could be due to the exhaustion of bullets, or the tired tool could decide not to automatically reload after a take a shot (which would be because there's a chunky metal stuck in your ejection port). So many reasons, but you get the idea already.

Now, a good shooter can pull out his magazine, cock his weapon & give the metal a shake or nudge to ease the jam, but this has to be done in about a second. And no, you're NOT going to do that. What you will do in case of an instant jam is to sling that pistol & pull out your merry little fella.

That little fella is your backup for some minutes. So, except you have about 30 of it tucked in your pants, you have to get a cover before your round exhausts & bring your main man back into the game.

Be Sure of Your Ejection Port: Yes, we all want to kiss John Wick & the Extractor guy (Hemsworth) for their shooting expertise, but not every one of their moves is that accurate — or at least real-life worthy, particularly when talking about bullet casings. All weapons

have their ejection port, which is where you find the bullet, but that never leaves the barrel of your gun. This port is called the casing & oh, is it hot!

The 1st reason to know the exact position of your casing is that it is where to look when your gun jams — like we explained above. Often, your weapon hand because a bullet was not properly struck & thus incorrectly fed into the gun, and the casing us where you will find this. You never can tell when you'll be carrying only one gun; you must know how to fix a jammed firearm as soon as possible.

The 2nd reason, which I bet you'll learn very quickly as a beginner, is that the ejection ports of some guns can eject bullet casings so forcefully that they'll land on your skin & burn a sweet little tattoo on you.

The ejection port is typically on the right side of your weapon, so if you're on the right of your shooting partners, you'll be suffering a lot of little burns. And here's what to do: suck it up! You all are trying to live

If I Pull the Trigger, You Run: If you're not shooting your gun, you should be running or taking cover. Your gun buddies should know this too. You all should form a synchronized system, such that when you're running, your partner is shooting to offer you cover — just as you should when your partner is running. You can do all this until you reach your bunker hideout.

This works when you're attacking too. You can alternate the covering & running procedures to get closer to your enemies. This is called the "fire & movement" technique.

Remember, the logic behind this is that repeated shots at your enemy's exact location will keep them pinned, seeking cover, so ensure to continue shooting at them until your man is safe. Your firearm should never jam at this moment.

Always Keep 3 Things in View: Your eyes have to be kept on three things as you duck, dive & pull the trigger. Now, I agree 3 is a lot to pay attention to when you're battling for life, but they are necessary. They are the bad guys, your partner & a possible cover. This is all to be focused on.

So, while in a gunfight, if you have to shoot at a running person, discharge a shot at their last seen place to let him believe he's fooled you. Then, be ready to blast off his head wherever else he pops up. The same principle applies to you. As soon as you hide so your enemy stops seeing you, move a few meters from there before showing yourself again. Your movement has to be lateral to the enemy.

Be Quick & Aggressive — Yet Calculative: Quickly do a mental assessment of the animals that rule the wild. All those topping the food chain (that I can think of now) are fast & aggressive with their attacks, but they do not neglect their sense or reasoning too. So, whenever attacking or retreating, I am recommending that you show some quick feet & aggression.

Bullets move very fast & you being all slow would be to see the cheetah preying on a goat. Pretty unfair. You have to move very quickly too. If you ever find yourself in a real shootout, your first line of defense is your quickness, aggression & confidence. But remember, do not let go of your calculations.

Plan Thoroughly — Like it's the last thing you'd do: For real, it could be your last act. Getting a bullet to the head or chest is no field trip, and it's an obvious death. So, what's the recommendation: plan, plan & plan.

Planning could be to fire a few probing shots at your enemy's direction to find out his exact location & his caliber of a gun or to cover your buddy while he runs a flank. Whatever it is, you need a plan & a backup plan (if that fails) & a second backup plan (if both fail). Keep in mind that there are plenty of tactics to employ when in a gunfight. A major influencer of your plans is your environment, although each location has its weaknesses too.

You have to be in the right state of mind, and I'm not asking you not to be afraid. In fact, fear is an excellent motivator. However, even if scared, maintain a level of clarity that will help you make plans to survive until another day.

Cover

Cover is very important in a gunfight. As little of your body as possible should be visible to the opponent. The cover must be strong and reliable. Brick, concrete, and stone walls are excellent cover. A thick enough wall may even absorb grenade blasts. In the wilderness, ditches, trenches, large rocks, and hills provide good cover. Trees could also be used, but they are less reliable due to lack of space they take up. Pick stronger woods if possible, so study the terrain. Oak could be used in Europe and ebony in sub-Saharan Africa.

Cars can also be used as cover. First, cars will not explode if shot at. Even if your opponent is using phosphor-tipped ammunition, he may just ignite at most 9 liters of fuel which will not be powerful enough to blow up a car like in a movie. The safest place to take cover in a car is behind the engine compartment, preferably behind the wheel for added cover. That is the place with the least open room and most heavy parts. It will protect you from calibers as high as .223. After that is the trunk, which is substantially less reliable. The car doors are the least desirable. Even a 9mm pistol can penetrate the doors. Remember that you can shoot from under the car if it is too risky to pop out of the side or top!

WW2 Films

There are multiple very good educational films produced for the US and British armies about gunfights and cover. On the next page are a couple:

Shoot To Kill: A British film about the importance of patience in war. The impatient troops quickly open fire before the enemy reaches the optimal position and lets them get away, while the patient troop waits for the perfect timing.

https://invidio.xamh.de/watch?v=UXqwh2o_zzs

How To Get Killed: An American film about the importance of cover. A Japanese sniper surrenders to the lone survivor of a group he massacred and tells him that it was his troops' fault that they died, as if they had taken good cover he would not have shot them.

https://invidio.xamh.de/watch?v=URwmZq70_DU

Kill Or Be Killed: An American film about the lawlessness of war. How one has to show no respect towards the enemy to neutralize them.

<https://invidio.xamh.de/watch?v=tGHxMXgw2Do>

CHAPTER XI: IMPROVISED FIREARMS

Improvised firearms are just that: firearms that you can make at home. These weapons will not be as reliable as proper firearms (especially with improvised munitions) but will be able to provide defense and terrorism. The main concern when the guerrilla is to manufacture improvised firearms is if he has access to a milling machine. If he does he will be able to manufacture much more accurate firearms and produce proper rifles. If he does not he will be unable to produce proper rifles but will manage to produce handguns, revolvers, shotguns and sub-machine guns. These are enough for self-defense and terrorism but not for warfare and proper combat.

Slamfire Shotgun

The slamfire shotgun is the easiest firearm to manufacture. No machines are needed and it could be manufactured under the most repressive regimes. The only difficult part would be to acquire ammunition for it. It consists of two pipes. The firearm is operated by slamming the barrel pipe against the breech.

Materials:

- 2 pipes (1 larger 1 smaller).
- Pipe cap.
- Spike.

Take 2 pipes of which one will fit neatly into the other but not too firmly. The pipe that will fit (the barrel) will be able to have shotgun shells of the chosen size put into it like a break-action shotgun. Put a hole through the center of the pipe cap and attach it to the larger pipe. Fasten a sharpened spike to the hole with the point into the pipe. The firearm is finished. Multiple barrels could be carried for firing multiple shells quicker.



Slamfire shotgun used in the attempted Halle synagogue shooting. The gun has a stock and grip attached and multiple shells stored around the barrel for easy reloading.

The slamfire shotgun should not be used for mass-shooting style operations as it is too slow. It can however be used in murders or self-defense. A good thing is that the firearm can be disassembled quickly and its disassembled parts if stored far away from each other will not arouse suspicion.

Flamethrower

The flamethrower is a very dangerous weapon that dispenses fire. Great caution should be employed when using the flamethrower, as the user could easily set themselves on fire. The flamethrower written about in this section is not to be confused for the methods of producing fire using a sprayer, gasoline, and a lighter. The flamethrower written about in this section is an actual dangerous weapon which could kill and set buildings on fire unlike the common improvised flamethrowers.

- Nitrogen tank. Compressed air can also be used, but it is less preferable.
- Fire extinguisher with an unscrewable head.
- Pressure washer rod with 2 unscrewable threaded fittings.
- Shut off for the pressure washer rod.
- Connecting nut and pipe.
- Propane torch.
- 2 hose clamps.
- Barometer (see the propane tanks guide for guidance).
- Fuel. Lighter napalm is very good.

1. Unscrew the empty fire extinguisher and fill it up half-ways with fuel.
2. Screw it back, and connect it to the nitrogen tank. The pressure inside the fire extinguisher should reach the 'green zone' (around 195).
3. Attach the propane torch to the pressure washer rod with 2 hose clamps, and attach the shut off too.
4. Disconnect the fire extinguisher from the nitrogen tank and connect it to the pressure washing rod.

Put a clamp down on the fire extinguisher, light the propane torch, and set off both shut offs for the flamethrower to shoot out a row of flaming fuel. The flamethrower might reach 10 meters. Beware that you would have to switch to another fire extinguisher if the fuel runs out. Ensure that no fire manages to enter the tank. If it does then run unequip the flamethrower and (if using pure gasoline or very weak napalm) run as fast as you can as the tank is likely to explode.

Online Resources

Here are some good resources for improvised firearms:

- <https://thehomegunsmith.com/pdf/Expedient-Homemade-Firearms-Vol-II-PA-Luty.pdf>
- <https://archive.org/details/practicalscrapmetalsmallarmsvol.1-22>
- https://archive.org/details/Poor_Mans_RPG_Shoulder_Fired_Anti-Tank_Weapon_George_Dmitrieff_Desert_Publicatio

And if you have a milling machine:

- https://archive.org/details/Home_Workshop_Prototype_Firearms_Bill_Holmes_Paladin_Press

Some of the guides will be archived here. This is so that the guerrilla can learn without the need of the internet.



Often falsely marketed as a clandestine U.S. Army weapon, the King Cobra is a three-shot .22 caliber firearm which has been produced in illicit workshops in Thailand since at least the 1980s. Measuring 4" long, 1 3/4" wide and with a mere 1/2" thick body, it can be easily concealed within a cigarette carton or top pocket of a shirt. The design allows for three successive shots to be discharged using one hand giving it a clear edge over most homemade weapons of this type. The mechanics of the gun are very basic and construction requires little more than a drill, hacksaw and steel plate.



Example shown open displaying three rounds of .22 Winchester Magnum.

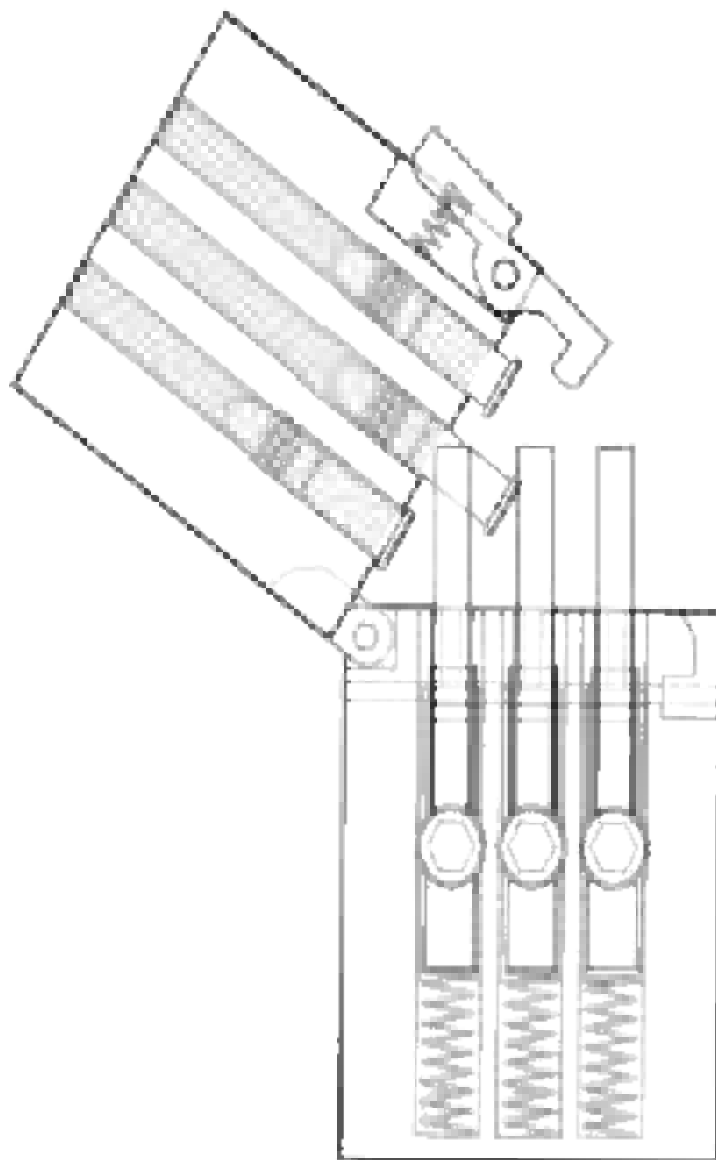

All pages included should be printed out on 8.5 x 11 US letter paper. Each component template is drawn to scale and can be cut out and glued to their respective thickness of material or used as a reference for measurements. Make sure the ruler at the bottom left of each sheet is 2 inches in length. Alternatively, take a screen-shot and enlarge the plans using a computer program until the ruler is the correct length, then trace the parts needed onto a sheet of paper taped over your computer's screen.

For academic study purposes only

Latch

Template:



Cut from 3mm thick steel plate

Add serrations using a hacksaw

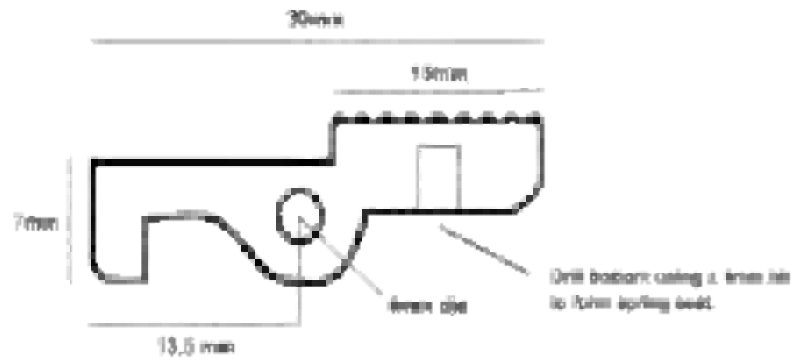

Latch spring: 4mm dia, 12mm long compression spring

Assembly:

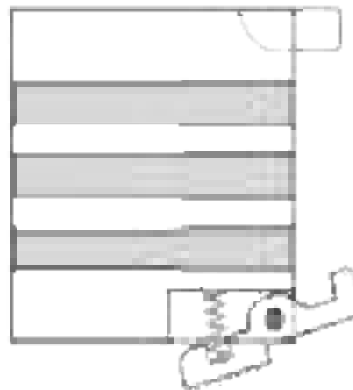

Secure latch to barrel using 1.8mm long, 3mm dia steel pin.

2 inches

Print on 8.5x11 US letter paper

Firing block

Cut from 1.2mm (1/2") thick mild steel plate

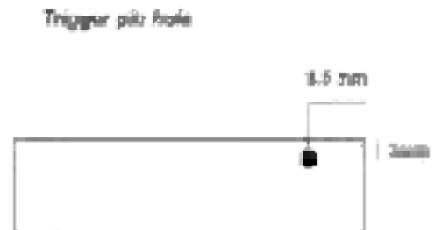
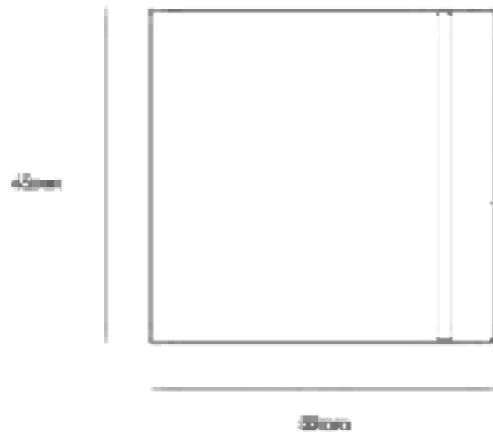

Drill through side using a 3mm dia bit as close to the edge as possible (Around 3mm in). Keep elevating the work piece towards your drill press chuck and use successively longer bits to reduce tendency to wander.

Barrel catch pocket

Done from front, drill 7mm deep using a 6mm dia bit

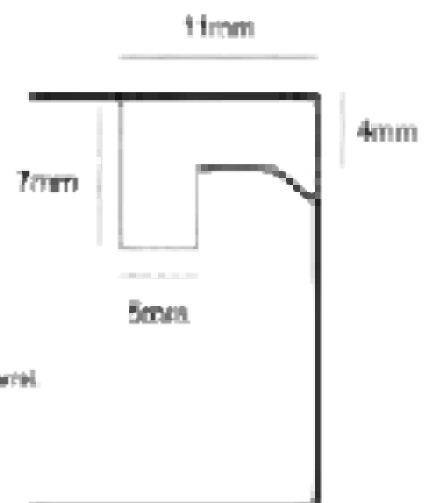
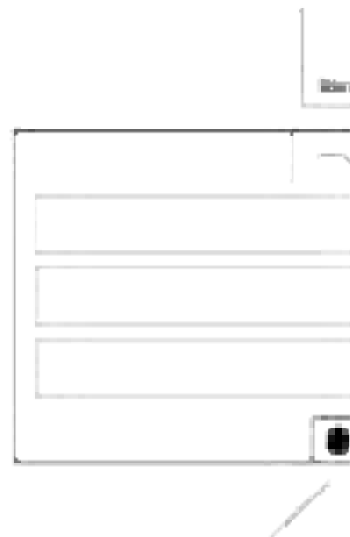

Cut a 5mm wide slot to accept hinge tab on barrel. Once aligned, drill a 6mm dia hole close to the corner, through both pieces to accept a 1.2mm long 4mm dia steel pin. Corners should be rounded slightly to allow free movement of barrel.

2 inches

Print on 8.5x11 US letter paper

Firing pin holes

Drill three 52mm deep holes at the positions marked using an 8mm dia bit. Drill 8mm deep using an 8.5mm dia bit and using a hand tap out threads for the first 5mm.

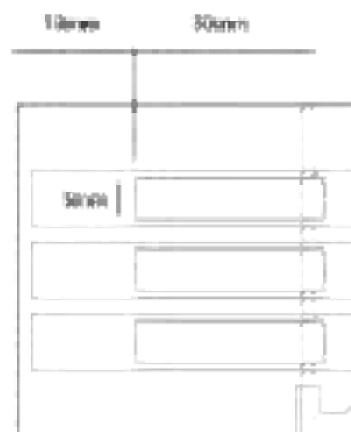
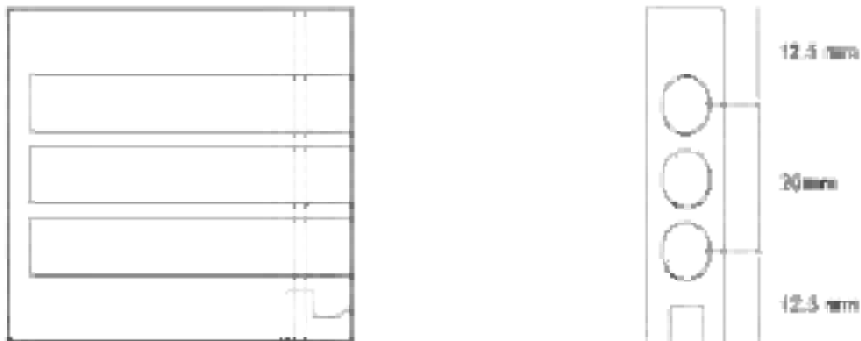

By 'chain drilling' a series of holes (and using a drill bit fitted with a 'reinforced cutting disc'), three 8mm wide, 38mm long cooling handle slots are produced above each firing pin hole.

2 inches

Print on 8.5x11 US letter paper

Firing pins

Make from a 37mm length of 6mm dia hardened steel round bar

1:1



Drill with a 4.2mm bit and tap for an M6 bolt

File down upper edge to a ramp profile

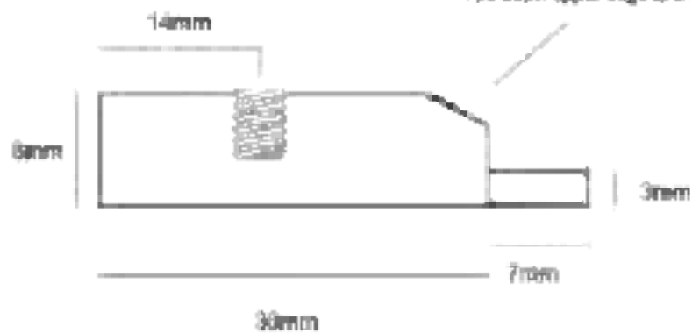

Front:



Cocking knobs

M6 x 6mm long socket head bolts x4

Each firing pin channel houses a strong 6mm OD, 1mm wire 20mm long compression spring.

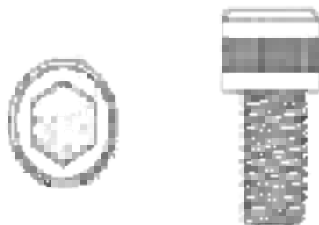

2 inches

Print on 8.5x11 US letter paper

Breach faces

Each breach face (x6) is made from a 4mm length cut from the threaded portion of a 15mm x 1.5 steel bolt.

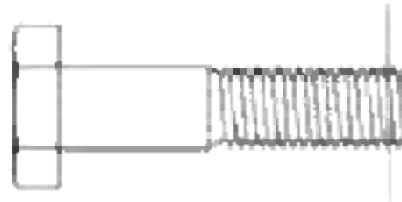
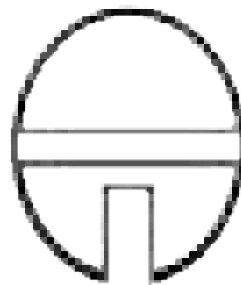

Figure 2: Breach face



4mm



4mm

Use a hacksaw to create a slot for a flat head screw driver to fit allowing each breach face to be screwed in place. On the under side use a hacksaw or drill to create a 3mm deep, 3mm wide channel for each firing pin to pass through.

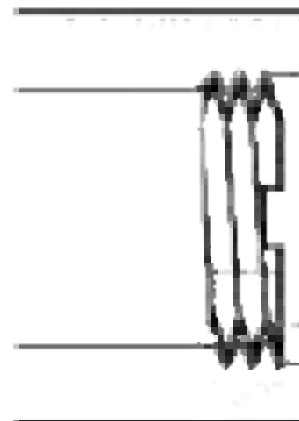

Screw in 1mm deep

2 inches

Print on 8.5x11 US letter paper

Triggers

Cut from 5mm thick steel plate. Hole dia is 3mm.

Templates:

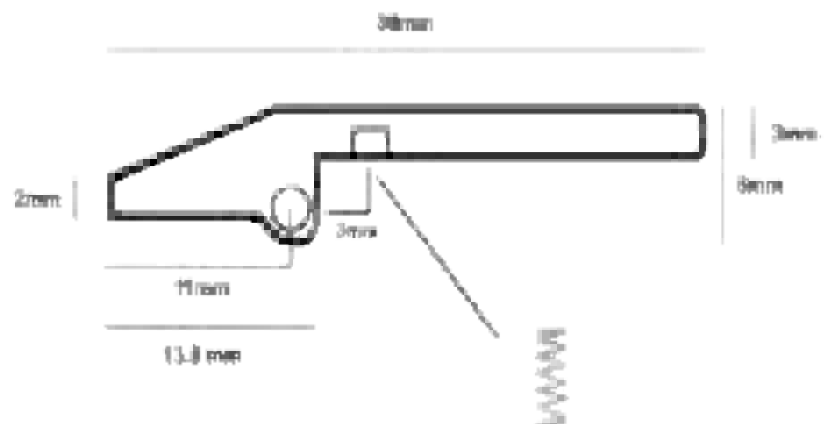

Seat for a 3mm or 4mm dia compression spring
(can be obtained from a retractable pen)

A 45mm long, 3mm dia pin retains all three triggers to the firing block.

2 inches

Print on 9.5x11 US letter paper

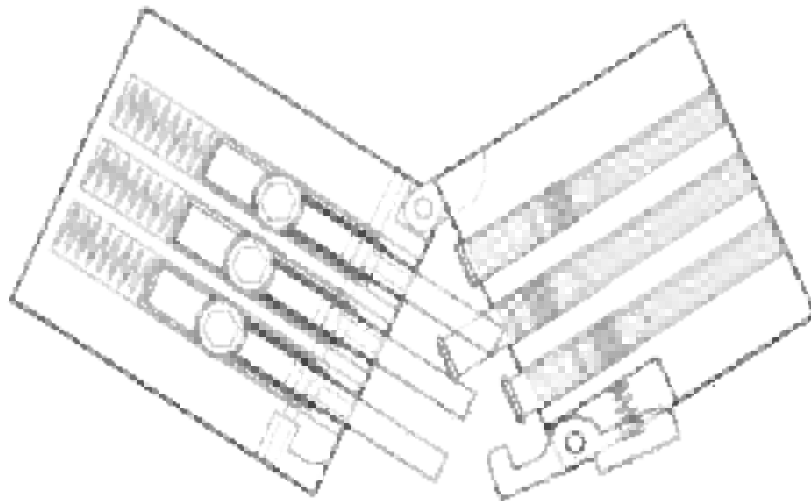
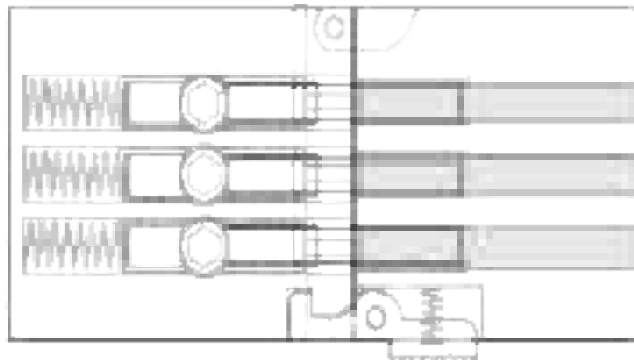

2 inches

Muzzle-loading adaption

The weapon may be made as a muzzle loader by adapting the chambers to fit three percussion nipples. These can be made by modifying an M6 bolt to the specified dimensions to accept a No.11 percussion cap or plastic cap taken from a toy cap gun ring. An improvised load can be made by crushing matchheads for the main powder charge and loading with a solid airgun pellet for a projectile. The firing pins and breech should be modified for center-fire.

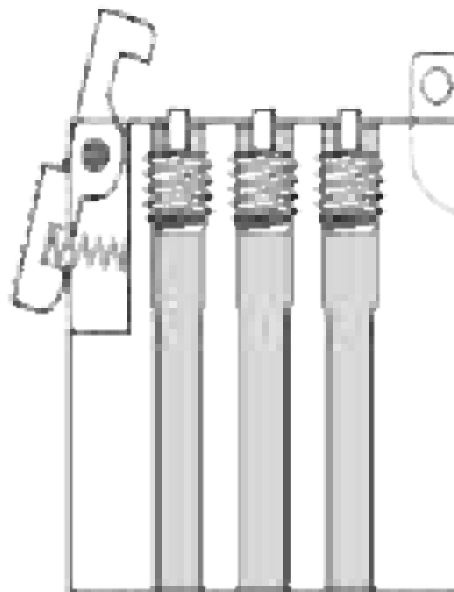

A 12mm long section of an M6 bolt is removed and drilled through in the center using a 2mm dia bit. With the lower 7mm section inserted in a drill press chuck, the 5mm long section is reduced in diameter using a hand file to simulate turning on a lathe. Tap each chamber 13mm deep using a 6mm bottoming tap and thread each nipple down tightly using locknuts to secure.

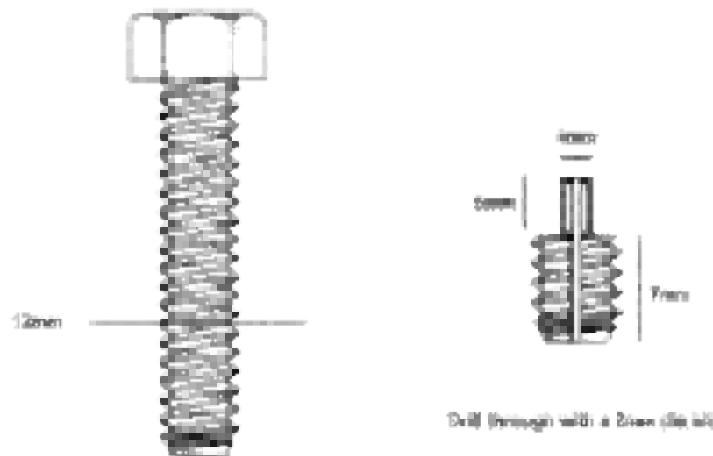

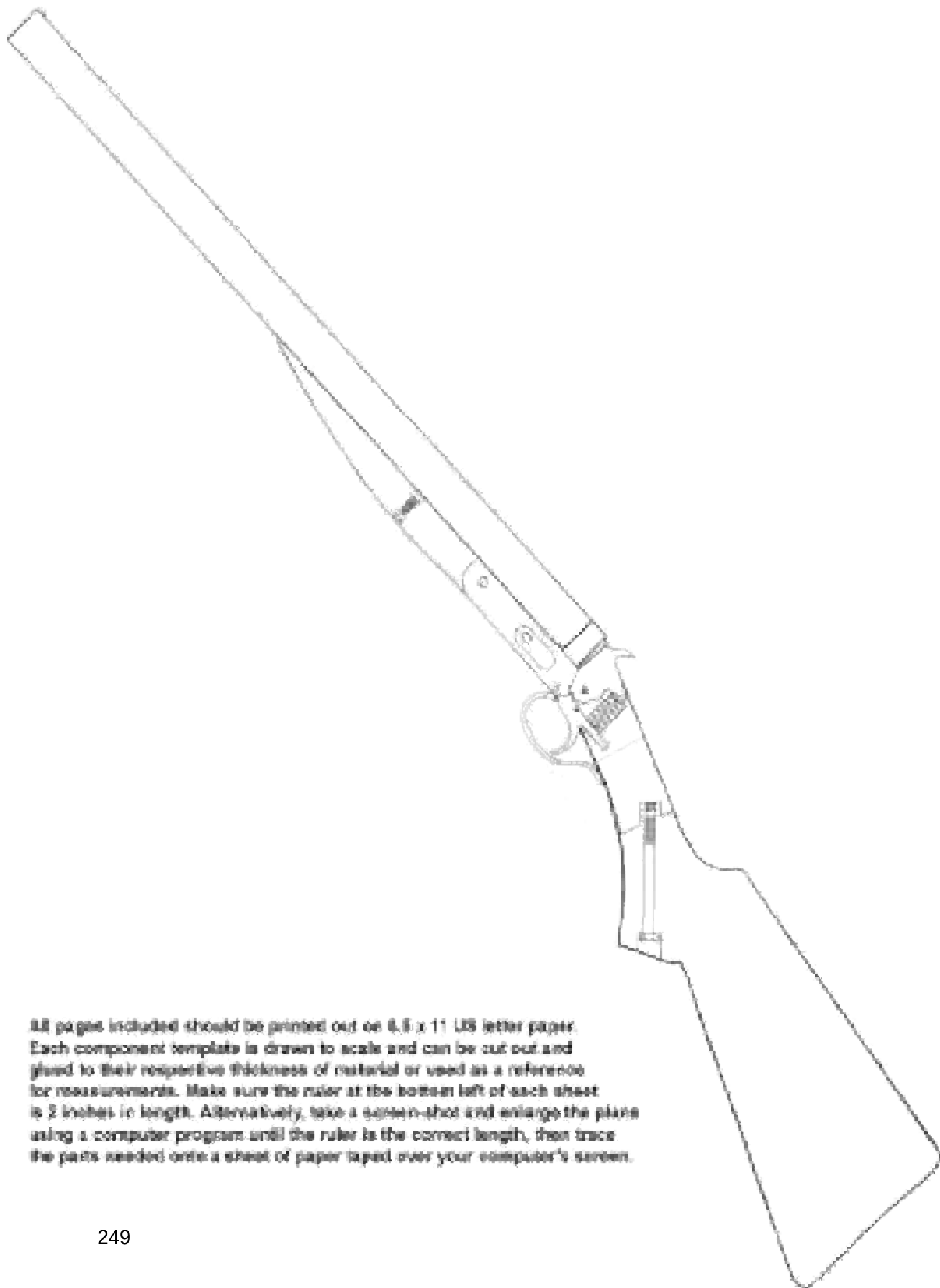

All pages included should be printed out on 8.5 x 11 US letter paper. Each component template is drawn to scale and can be cut out and glued to their respective thickness of material or used as a reference for measurements. Make sure the ruler at the bottom left of each sheet is 2 inches in length. Alternatively, take a screen-shot and enlarge the plans using a computer program until the ruler is the correct length, then trace the parts needed onto a sheet of paper taped over your computer's screen.

Frame & trigger group templates

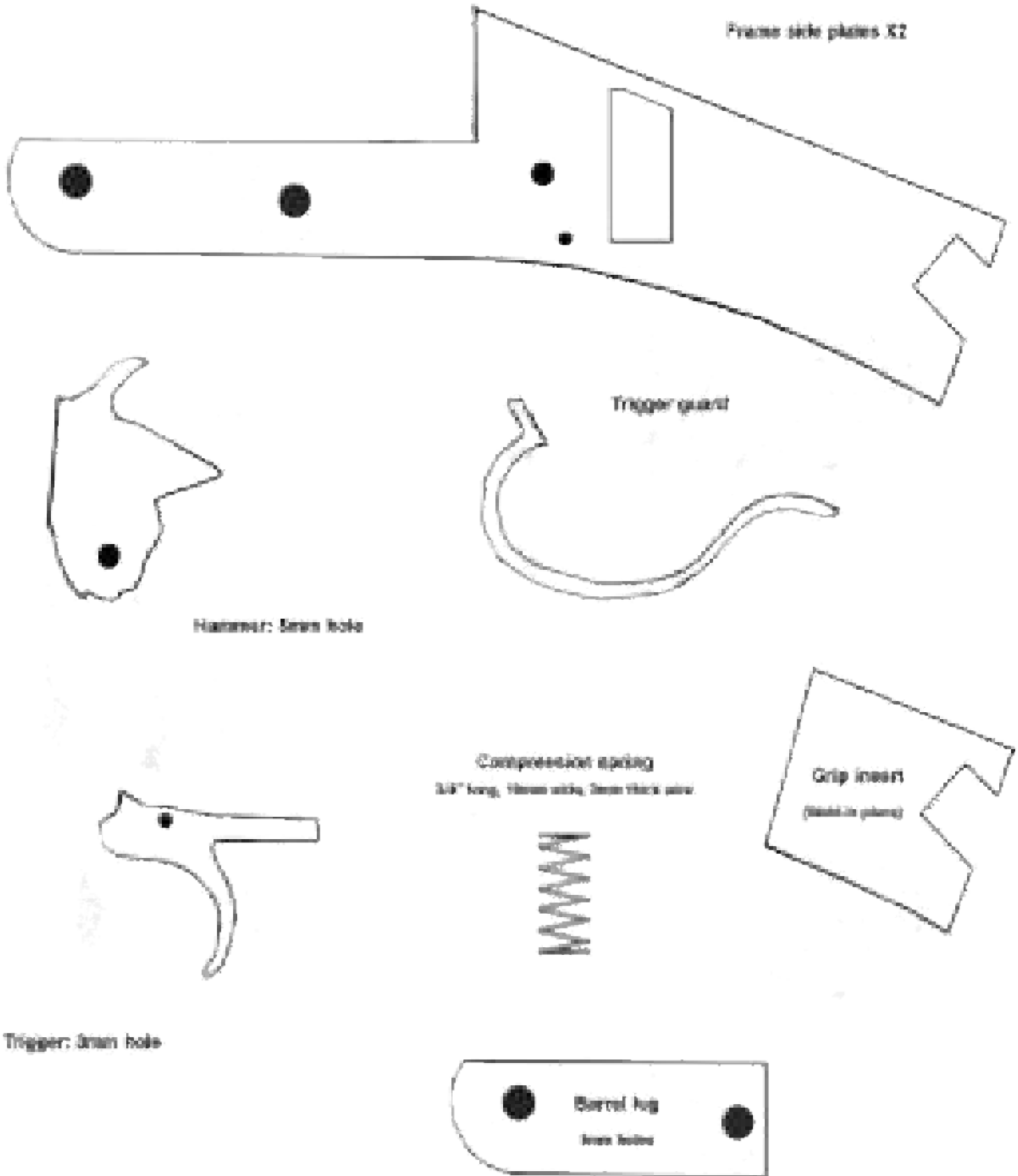

Obtain with appropriate size 17" long pins or rods & bolts

2 inches

Print on 8.5x11 US letter paper

Frame side plates : 1/8" (1mm to 3mm thick) mild steel plate
 Hammer, trigger, grip insert and barrel lug : 1/8" (3mm) thick mild steel plate
 Trigger guard : 3mm thick, 8mm wide, 4.5" long mild steel strip

Breach assembly

7" dia mild steel round bar, 15mm long

Drill with a 2mm bit through front. Bore out rear with a 6.3mm, 12mm deep.

Drill a hole from above until entering firing pin channel. Add threads with a 4mm hand tap.



Side

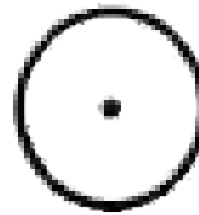

Front

Firing pin

(6mm dia silver steel bar)

Split in a drill press and use a hand file to taper down front portion to dia.

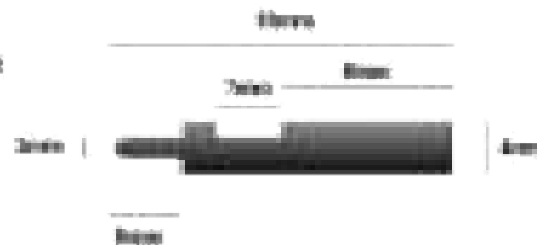

Assembled:

A small dia compression spring taken from a pen is modified by shortening it to 3 or 4 coils and is positioned in front of the firing pin.

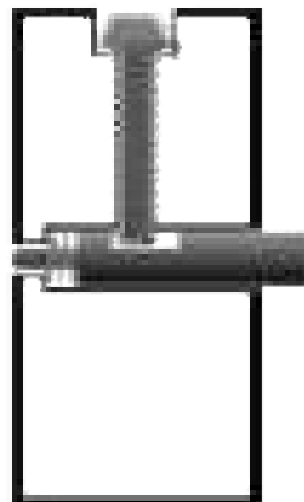

Thread a 10mm long m4 bolt down until firing pin is made freely captive via its slot. Apply lockfile to bolt to retain in position.

Insert a piece of 1/4" (6mm) plate between side plates to ensure correct inner dimensions remain while welding frame components together.

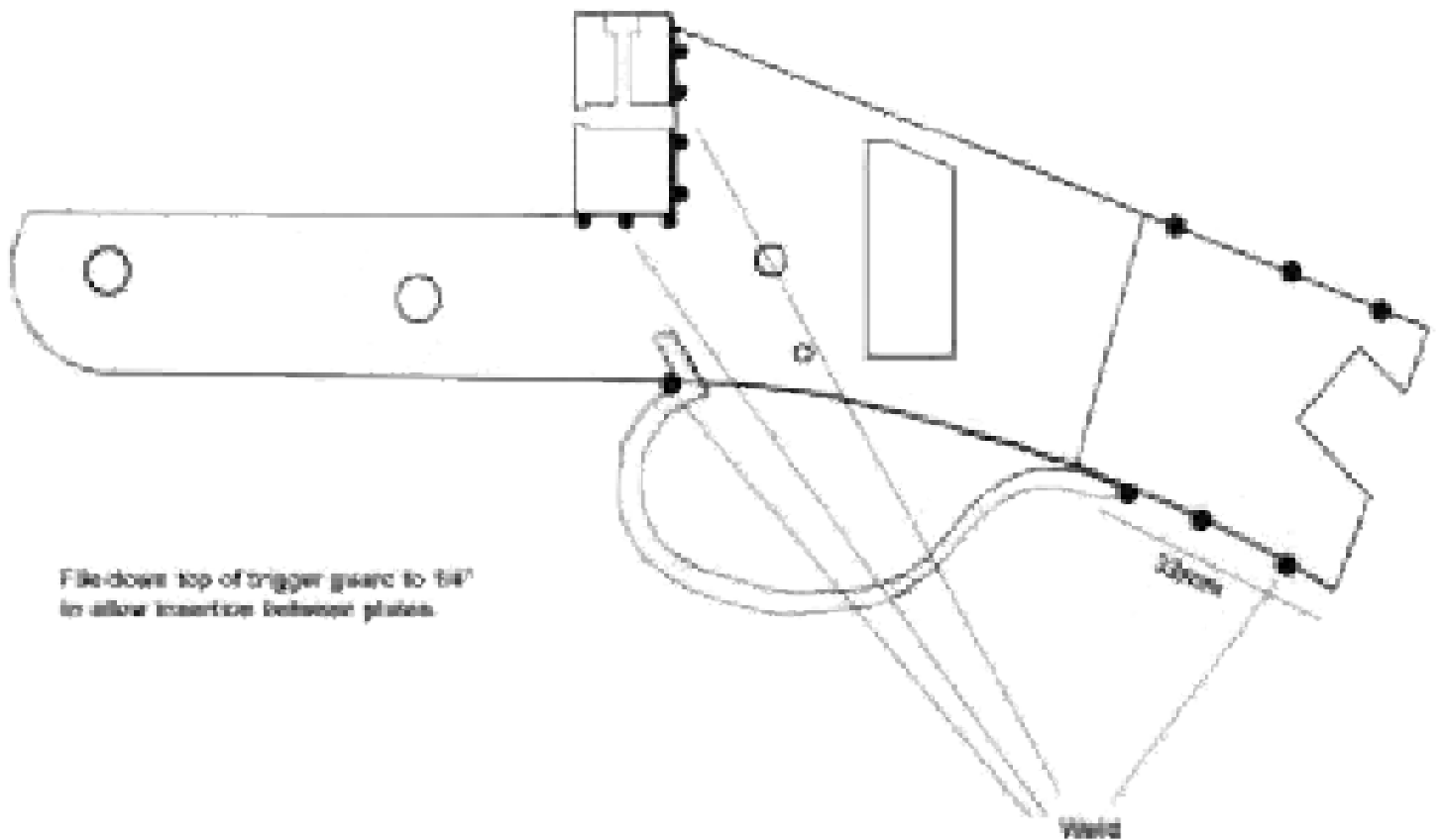

File-down top of trigger gear to fit
to allow insertion between plates.

2 inches

Print on 8.5x11 US letter paper

Barrel

1" outside diameter, 3/4" inner diameter seamless steel tube, 20" long. Can be sleeved with a section of 1" inner diameter steel tube for maximum thickness.

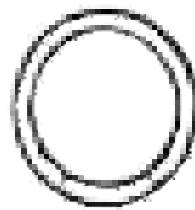

File shallow extraction cut into lower wall

Bevel inner wall using a drill to accommodate rim



Weld or brace an M3 nut to bottom of barrel

Drill a 2.5mm hole and tap for an M3 button head bolt to serve as a sight bead



Barrel lug and latch

Weld lug onto barrel before drilling through corresponding holes in frame to ensure tight fit and alignment.

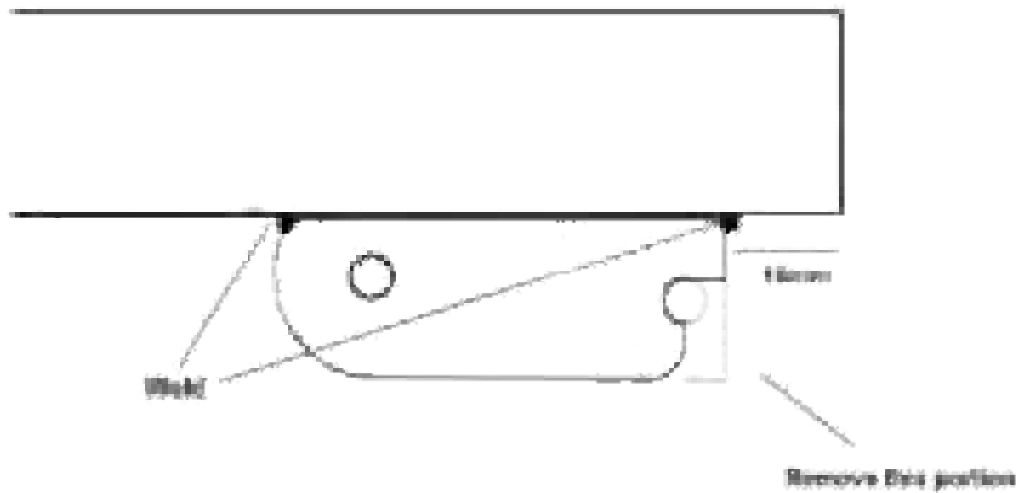

Latch

Tap a modified 1" long mill bolt into a length of 3mm steel plate. Weld at front. Apply thread locker to ensure firmness in both closed and open positions.

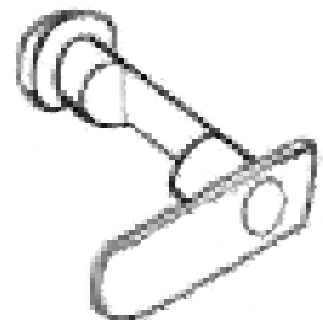
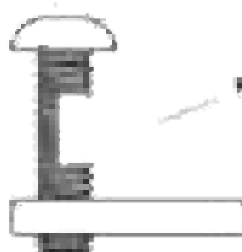
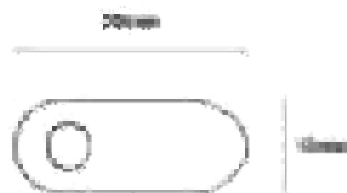

2 inches

Forearm

1" or 1.5" thick hardwood
7.5" long

Front profile:

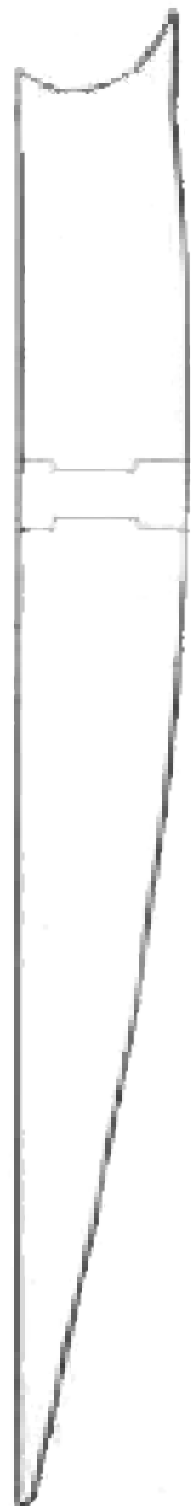
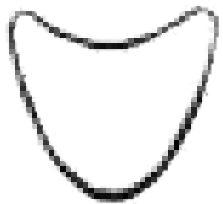

Drill a hole 1/8" from front
to accept an 8/32 bolt

2 inches

Stock

1.5" thick hardwood

14.5" long

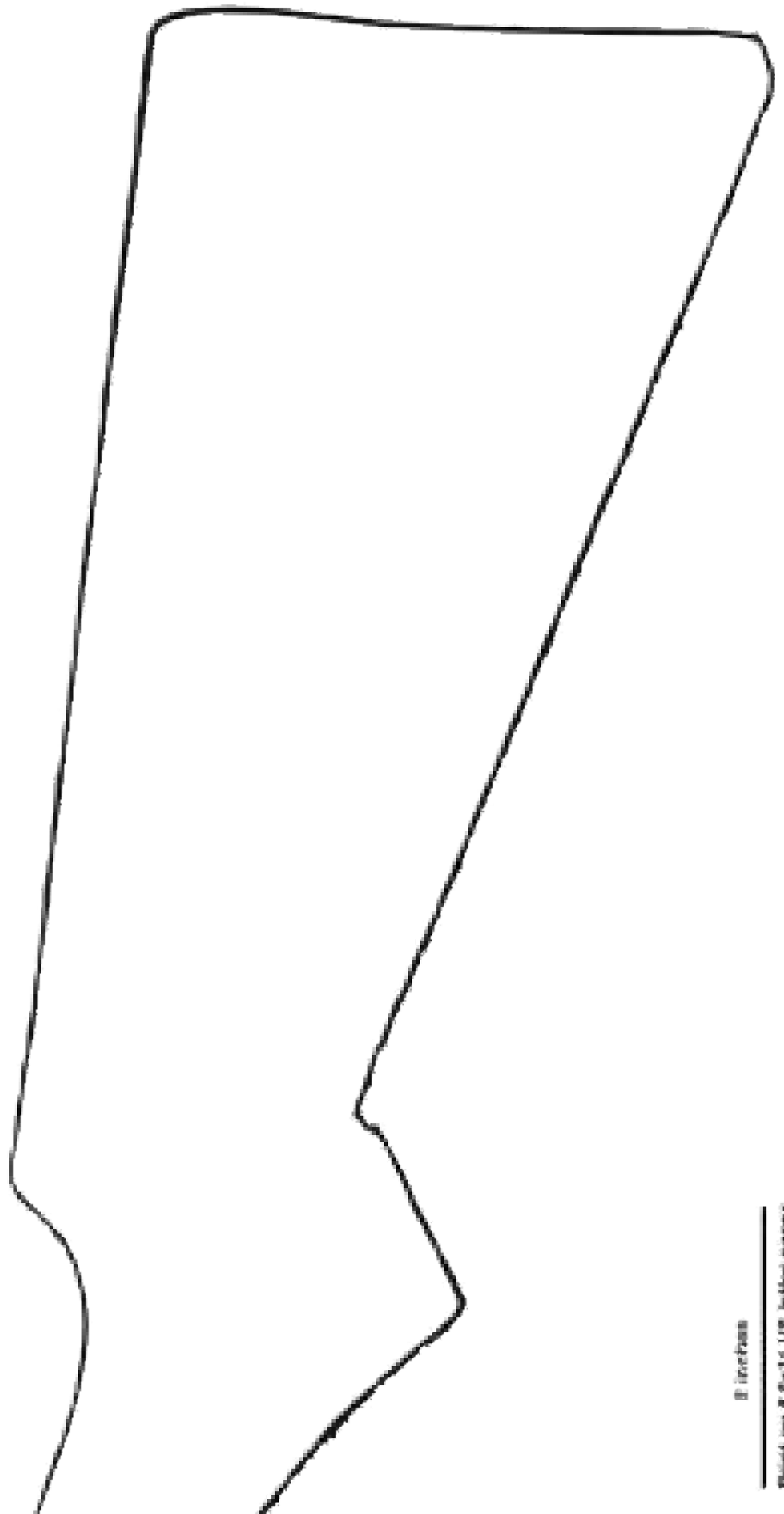

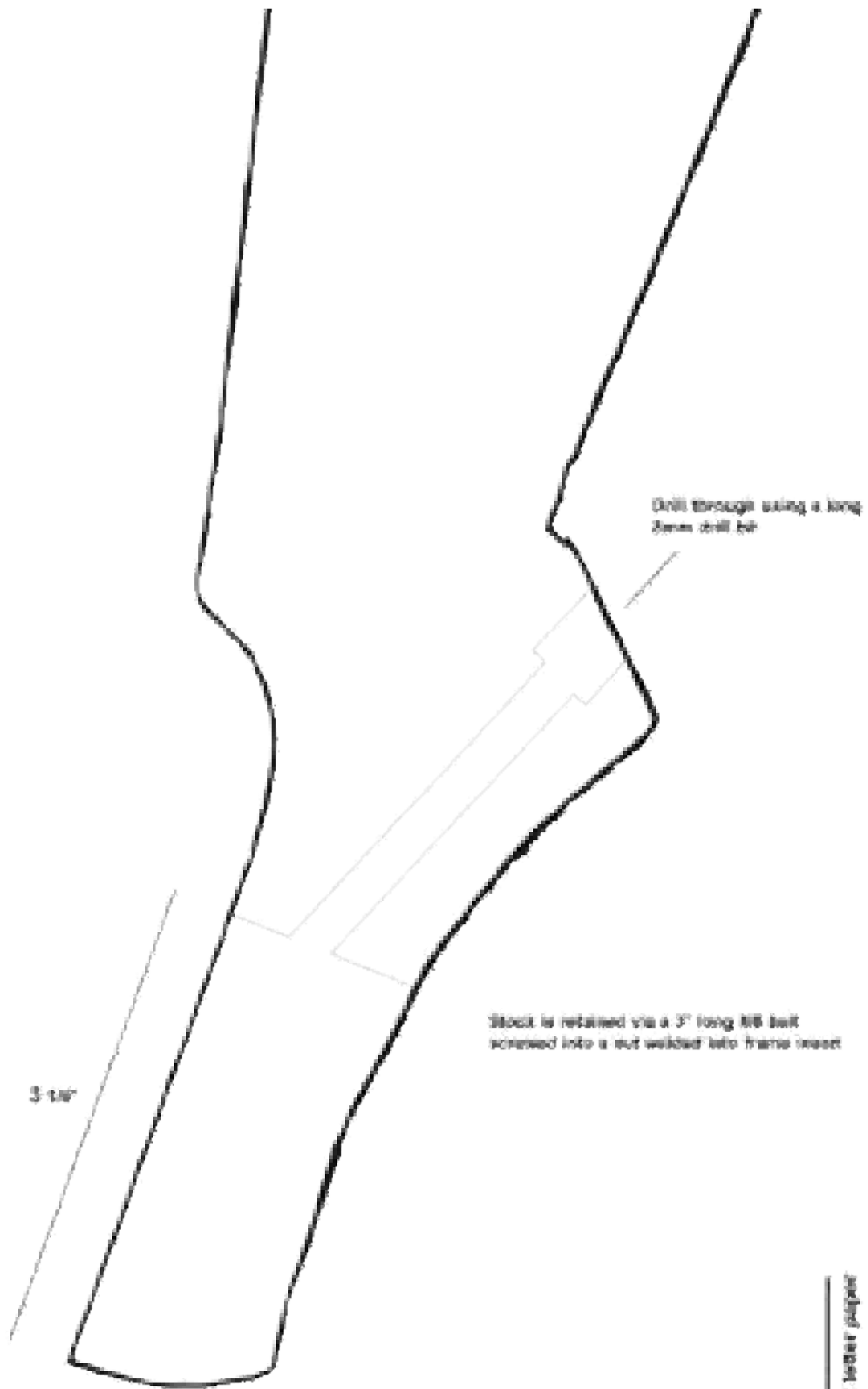

Carve out a 1/4in wide, 7/16\" deep slot through middle to accommodate rear of flange

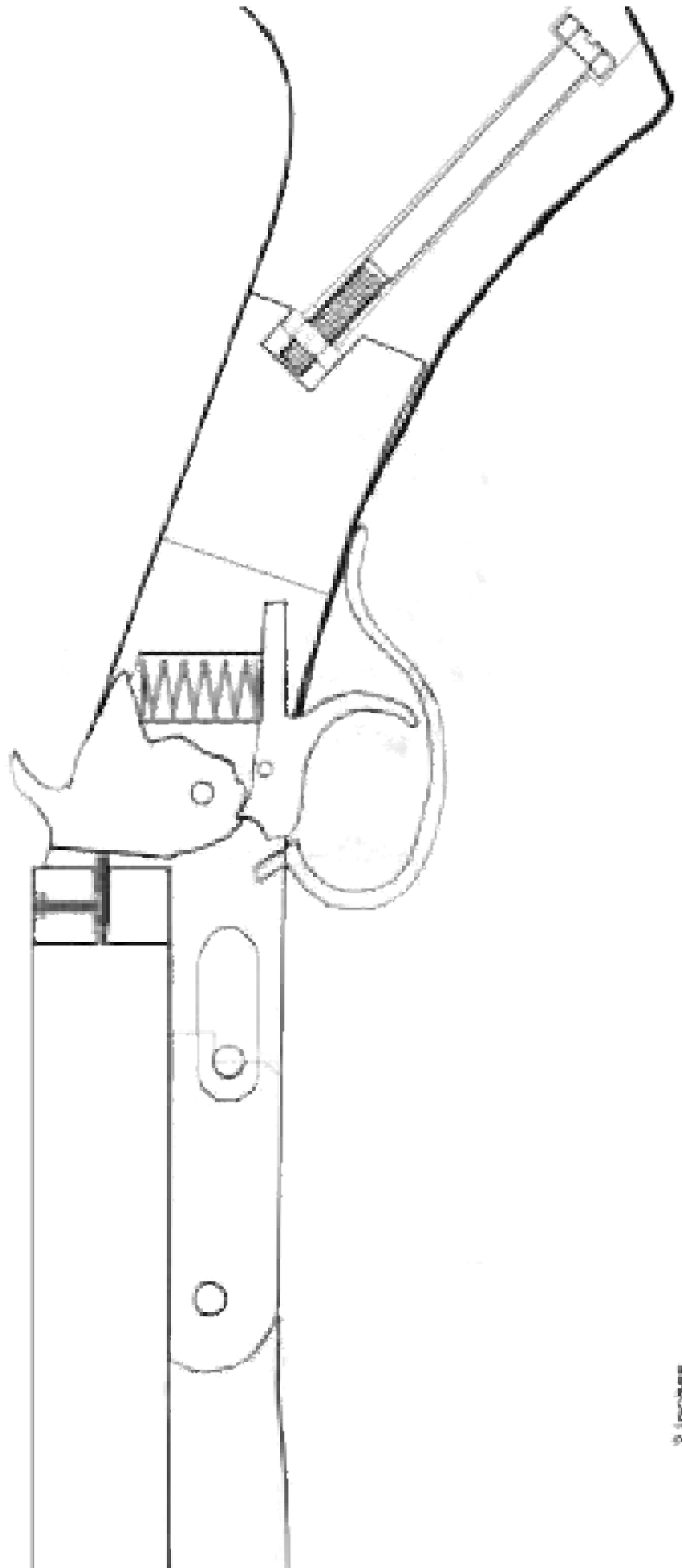

3 inches

Print on 8.5x11 US letter paper

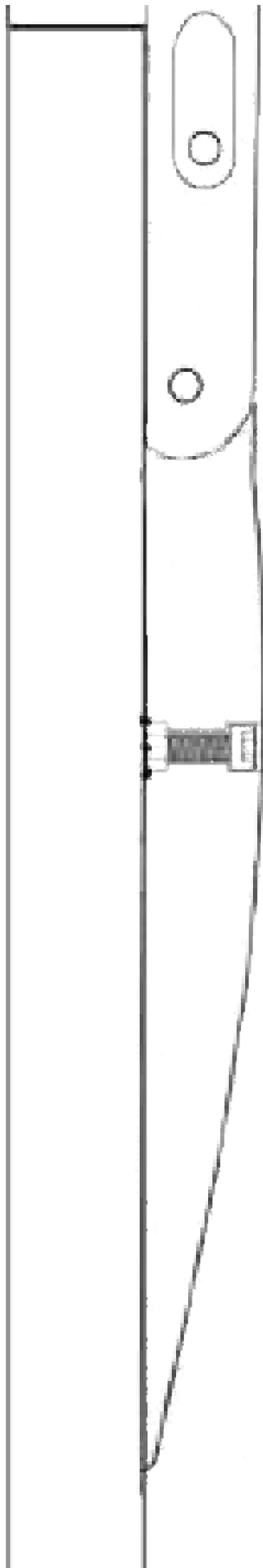

2 inches

Printed on 24x36 inch letter paper

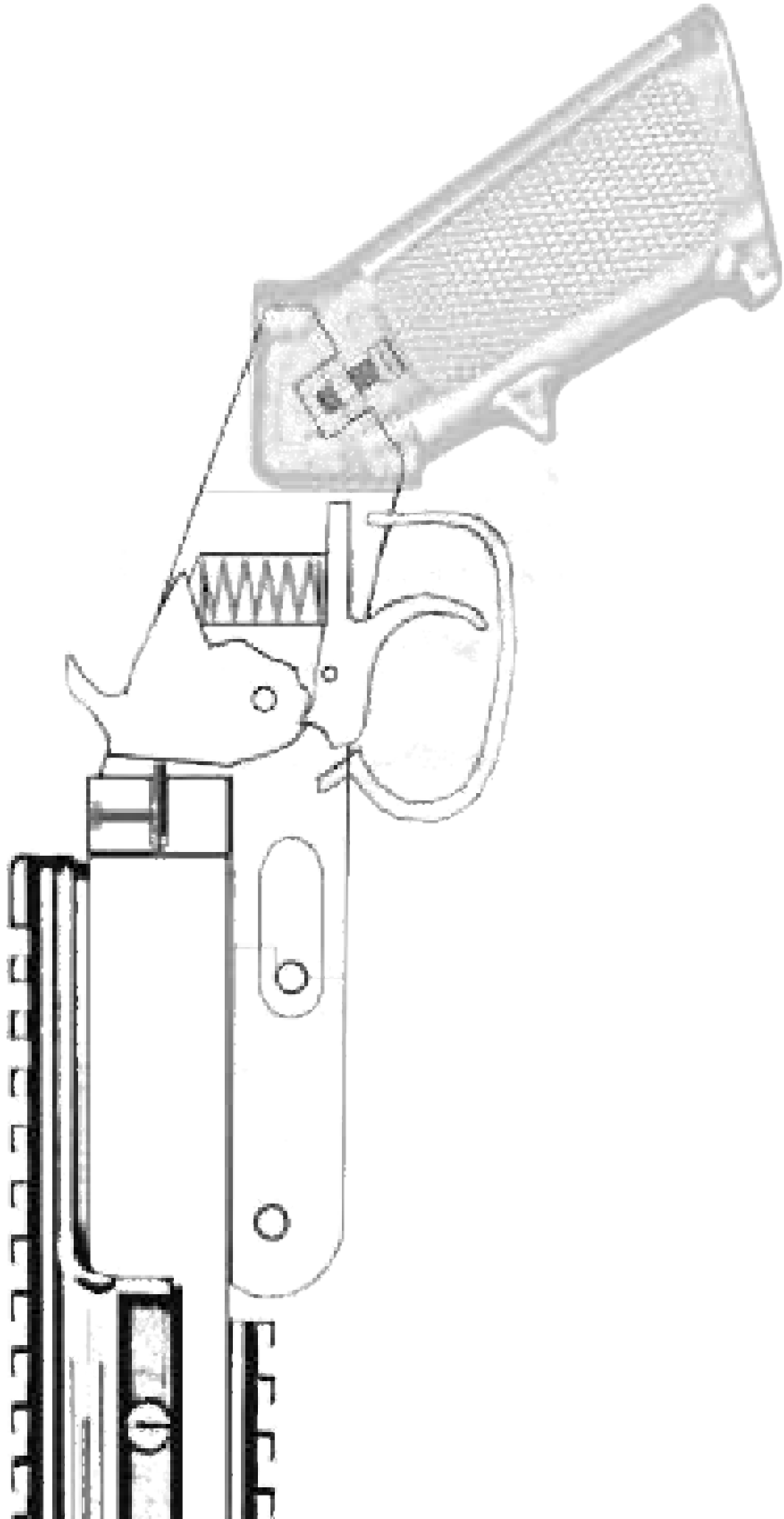

2 inches

Print on 8.5x11 US letter paper

Frame modifications to accept an M16 / AR15 pistol grip

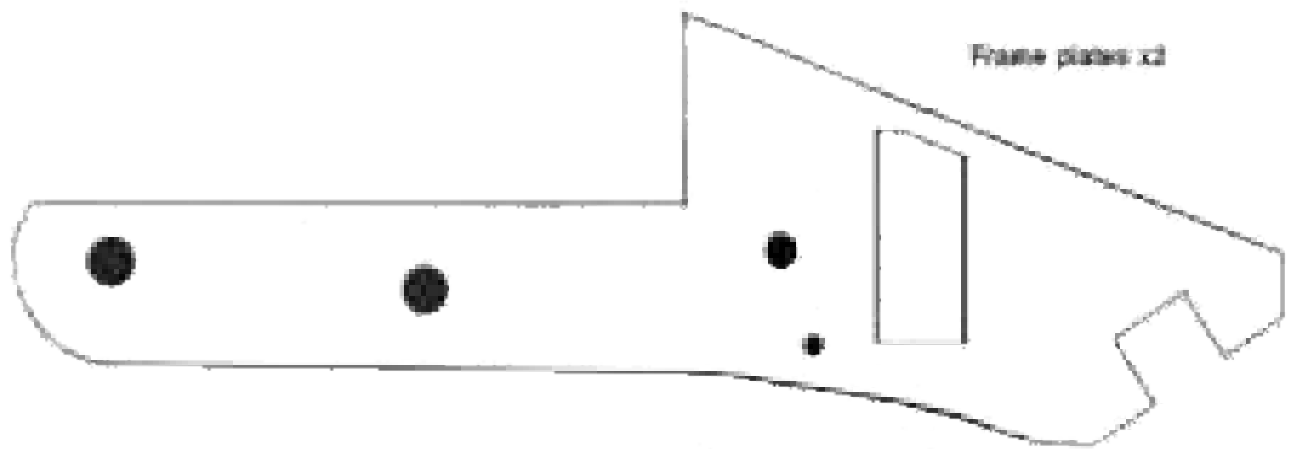

Spring channel cover x2

- Secure in place with two 14mm long pins

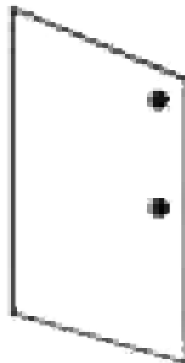

Grip insert

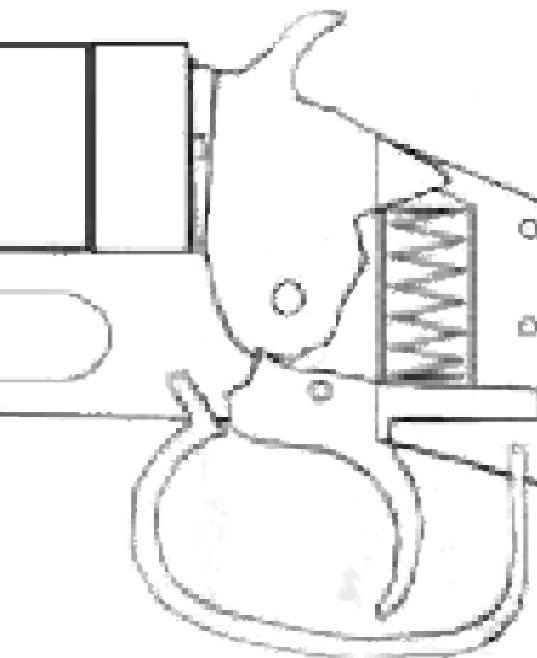
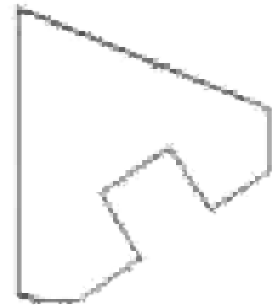

Reduce thickness of rear portion to 8.5mm using an angle grinder

Weld an M6 nut in place and secure grip with an M6 bolt

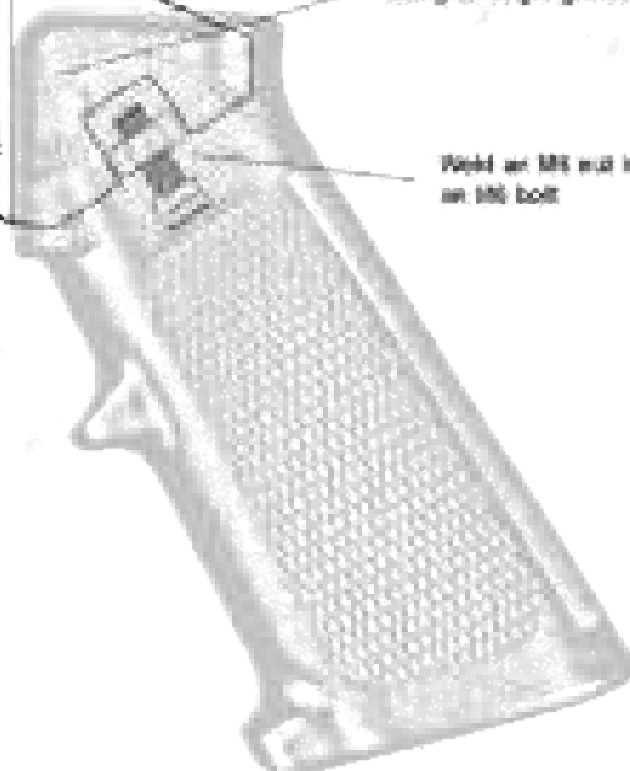



Non-tilting cleaning rod is installed in Remington-Union City gun toybook configuration.



Practical Scrap Metal Small Arms Vol.9
By Professor Parabellum

Introduction



The simple machine pistol detailed here is very similar to other widely tried-and-tested expedient designs in circulation, though improved upon in terms of compactness, handling and ease of availability of materials required. It's essentially a homebuilt version of the Armenian K6-92, a compact machine pistol widely copied in the early 1990s by various separatist groups following the breakup of the Soviet Union. The commercial counterpart was chambered in 9x18 Makarov, though the general design adapts well to .380 or 9x19. This basic simplified version uses 9mm STEN magazines and includes an adaptable bolt weight system in it's design. Construction does not require a lathe or milling machine and only very basic tools may be used.



*For legal reasons the prototype shown was constructed as a non-firing legal dummy display model for purposes of demonstration. It has a blocked and destroyed dummy barrel and it's bolt contains no provisions for a firing pin. **This document is presented purely for academic study purposes only.***

Bolt construction



The bolt used in this design is a laminated assembly consisting of two sections of steel box tube and bar stock, either held in place via thick steel pins or permanently welded together. Additional bolt mass is provided by way of a 3" x 1" steel plate which rides above the receiver, also doubling as a cocking handle. It's possible to stack further plates on top of the assembly, each adding around 100g extra weight.

Barrel



The barrel is assembled in an identical manor to the bolt and includes a reliable integrated feed ramp formed into it's square tubing collar. All three parts can be held in place via several steel pins or be permanently welded together.

Trigger group



The trigger group consists of two pieces cut from 6mm thick steel plate which rock up or down under spring tension, either allowing the bolt to pass or be held back. The trigger housing is constructed from three pieces of steel plate and is welded onto the receiver once complete.

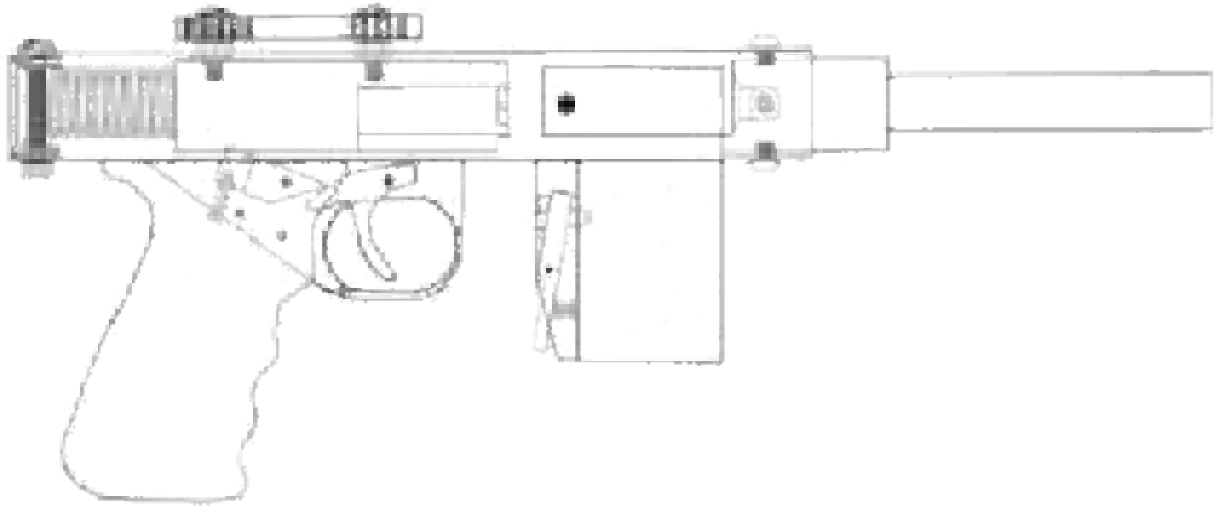

Tools:

Drill press
Cobalt tipped drill bits (Optional)
Welder
Angle grinder + 1mm slitting disc
Dremel / Rotary tool + grinding bits
Hand files
Hacksaw

Materials:

30mm x 30mm x 2mm wall mild steel box section tube
25mm x 25mm x 2mm wall mild steel box section tube
20mm x 20mm x 2mm wall mild steel box section tube
25mm x 50mm x 2mm (1" x 2") rectangular box section tube
6mm thick (1 1/4") mild steel plate
2mm or 3mm thick mild steel plate
16mm (5/8") mild steel round bar stock
1 1/2" thick hardwood or plastic

Plans

All pages included should be printed out on 8.5 x 11 US letter paper. Each component template is drawn to scale and can be cut out and glued to their respective thickness of material. Make sure the ruler at the bottom left of each sheet is 2 inches in length. Alternatively, enlarge the plans using a computer program until the ruler is the correct length, then trace the parts needed onto a sheet of paper taped over your computer's screen.

Receiver

38mm x 38mm
square mild steel
box tube
x 3mm thick wall

247mm long

Top:

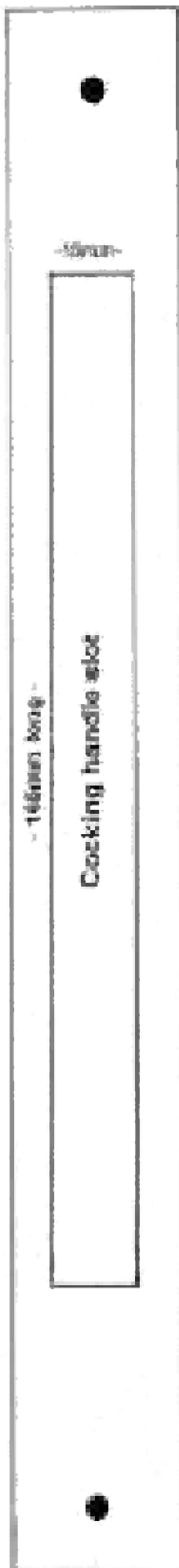

Right side:



Left side:

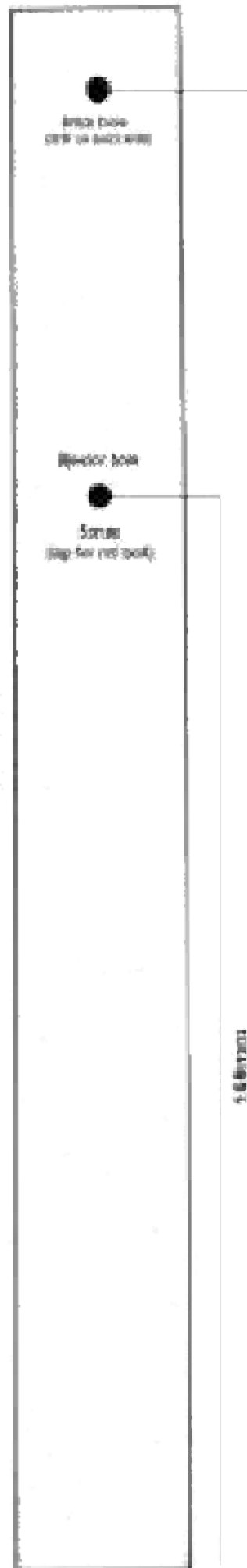

12mm

146mm

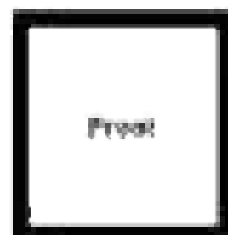

2 inches

Receiver Pt.2

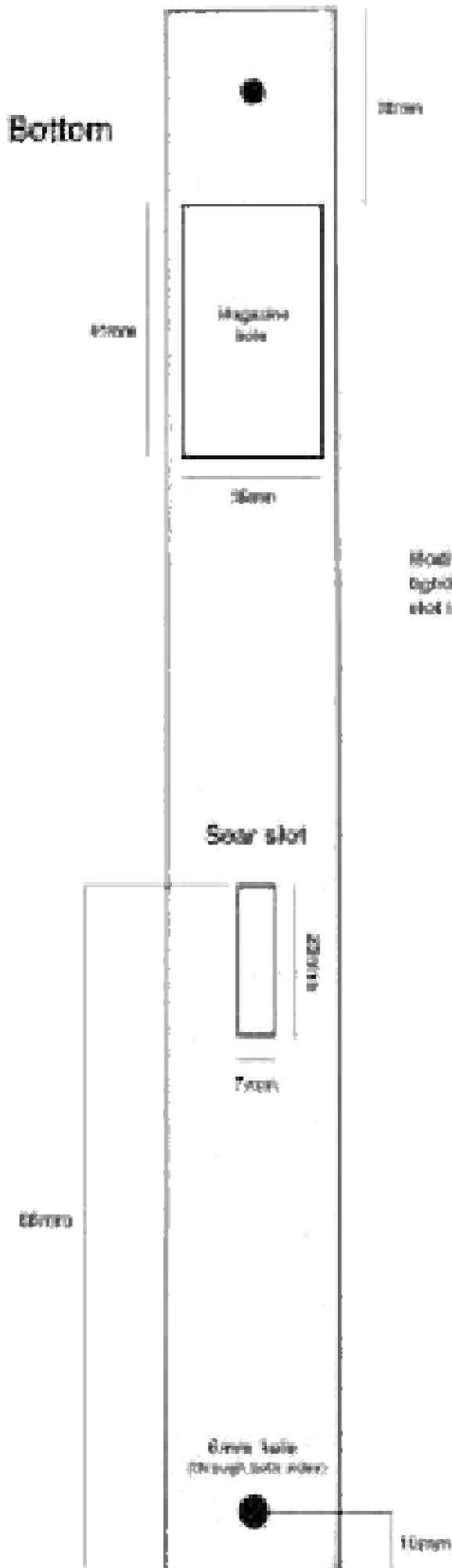

Ejector

Modify a 1/2" long m6 bolt into a blade profile. Screw tightly into the ejector hole until aligned with slot in bolt. Apply torque to fully secure.



3 inches

Trigger housing

Template:

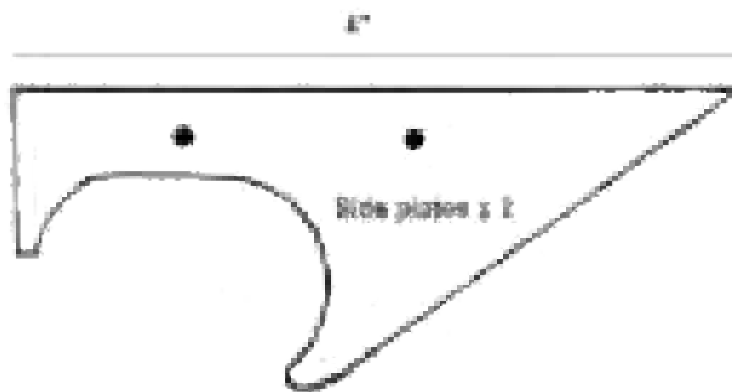

Band a 70mm length of 3mm wide mild steel strip (3mm thick) to profile below:

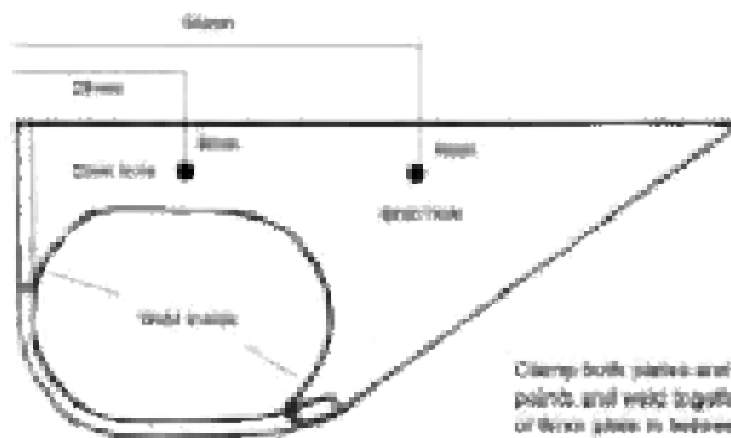
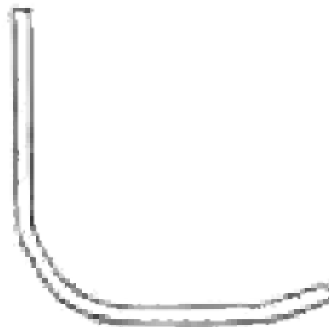

Clamp both plates and trigger guard together at contact points and weld together inside trigger guard. Insert a piece of brass plate in between to assist.

Drill holes once welded to ensure accurate alignment.

2 inches

Trigger & sear

Cut from liner thick (1/4") mild steel plate

Trigger template:

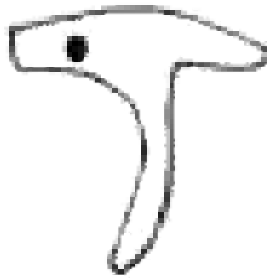

Sear:

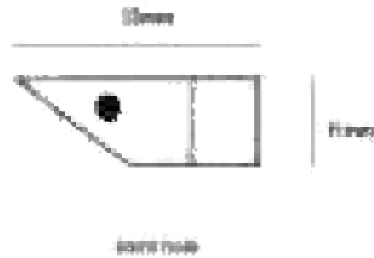

Materials: Spring steel, stainless steel, titanium



Assembled:

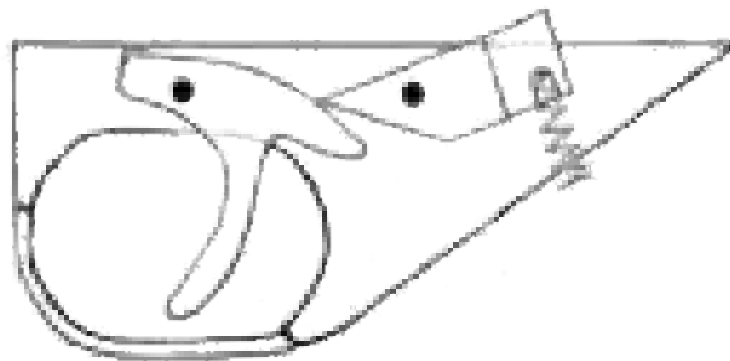

Trigger accepts a 10mm hole in the body

Sear accepts a 10mm pin or holeless section of the body

Manipulate spring with pin or wire in hole to seat

0.005 wide x 1.0mm long



1 inches

Magazine-well (for STEN magazines)

A 57mm length of 1" x 2" (25mm x 50mm x 2mm wall) steel rectangular tube is modified by removing a single 1" side to enable both 2" sides to be flared out slightly in order to accept a STEN magazine. A section of 1" steel bar can be hammered down through the opened side to achieve this. The removed side is then welded back into place forming the correct inner dimensions. Use a STEN magazine for reference throughout.

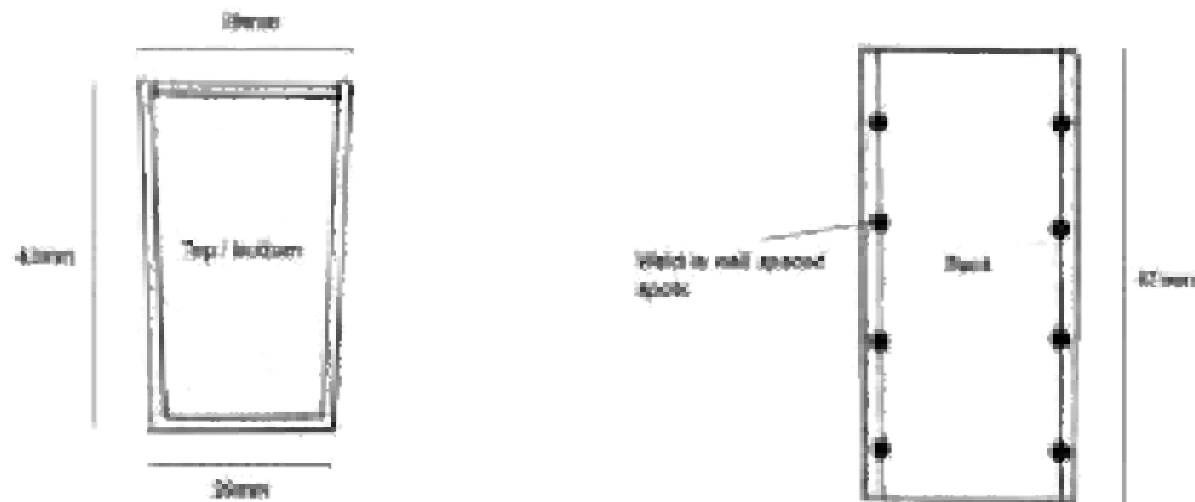

Magazine catch housing

Made using 10mm wide steel bar/slide or bent from 10mm steel sheet.

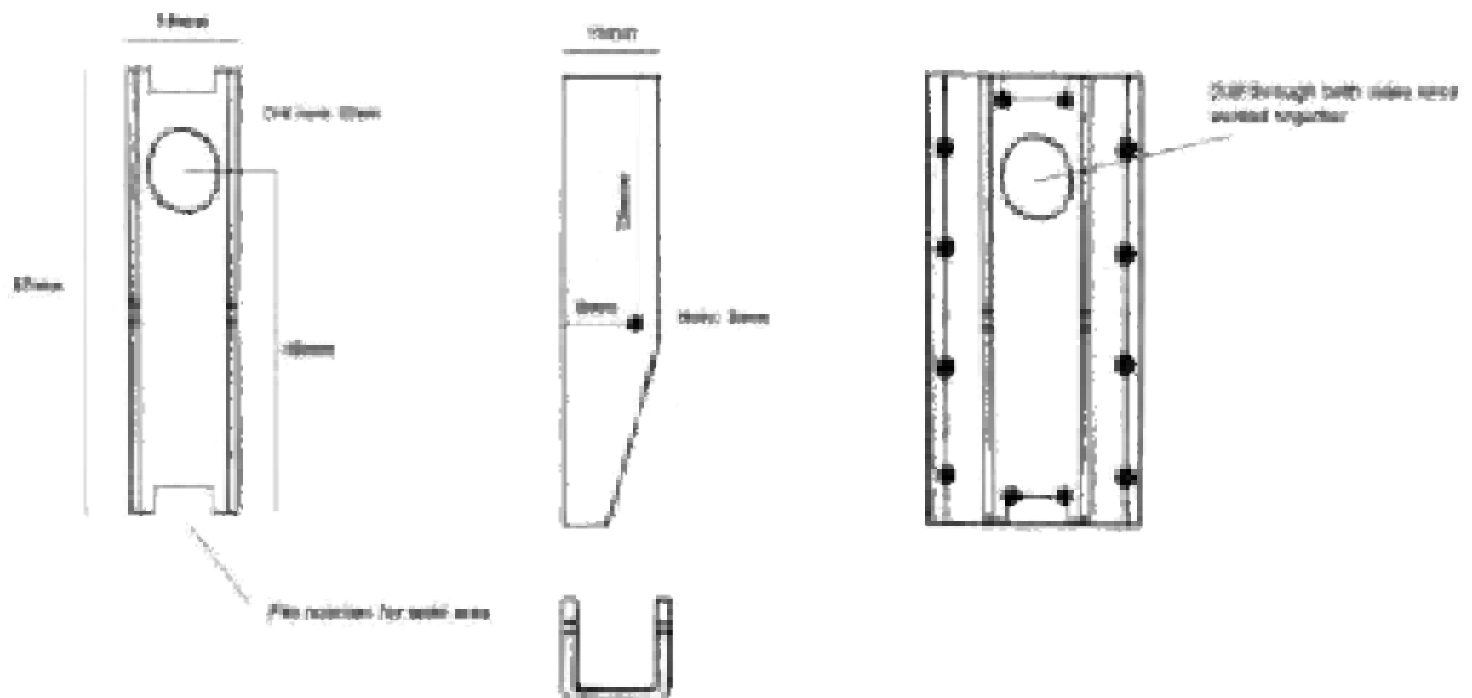

2 inches

Magazine latch

Assemble from a strip of 6mm (1/4") thick aluminum- or plastic plate + M3 bolt

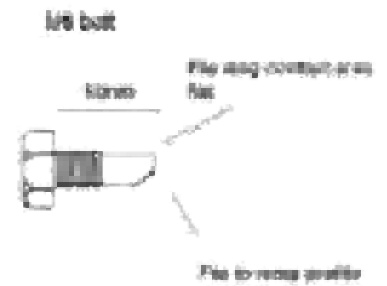
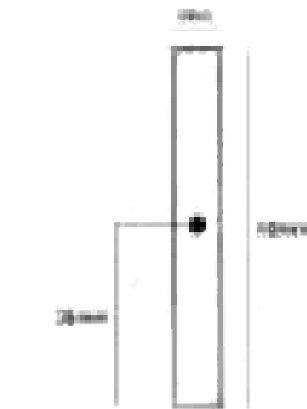
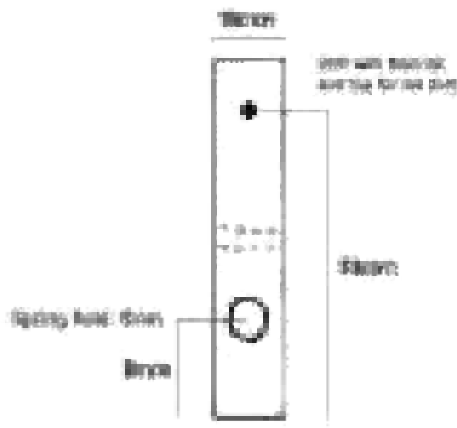

Tightly screw into plate and modify as above while in place.

Catch spring: compressed / 10mm wide, 16mm long

File flat

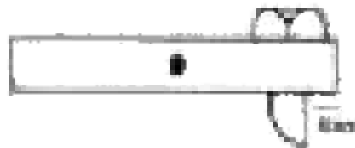

File down contact area until snug against top of hole in magazine.

Attach to magazine wall using 16mm long M3 bolt + nut



2 inches

Alternative magazine-well + STEN mag modifications

A length of 20mm x 40mm steel rectangular box tube with a wall thickness of 2mm will facilitate a magazine made from 16mm x 30 / 35mm tube.



Mounting tab
2mm thick mild-steel

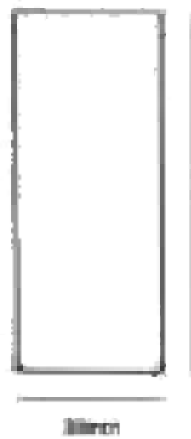

ISS bolt
16mm

- File magazine contact edge flat
- Form ramp profile on under side
- Retain with an iso nut + bolts

Spring steel strip
(Cut from a section of hand saw blade)



Bolt latch strip to mounting tab and weld assembly to back of magazine well.

Position to drill catch hole in STEN magazine



Drill with drill bit (with catch raised - contact head (faces from mag shoulder)

2 inches

Homemade 9mm magazine

To form the magazine spring, tightly wind a length of 20 gauge spring steel wire around a 1/8" long 24mm x 8mm bar leaving a 18mm gap between coils - once complete cut spring to 12" long

Body is constructed from 18mm x 18mm (1.6mm wall) mild steel box tube
- 7" in length

lips should be bent inward with spaced
lips apart and able to retain a cartridge

Cut out 2mm strip of back wall
to allow lip to be formed

151mm

File ramp profile
outside

40mm x 20mm tube
cut-off

Silver solder or
epoxy in place

Followers

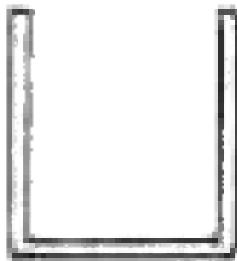

Made from a 40mm long
18mm wide mild steel strip
- Should screw freely in tube

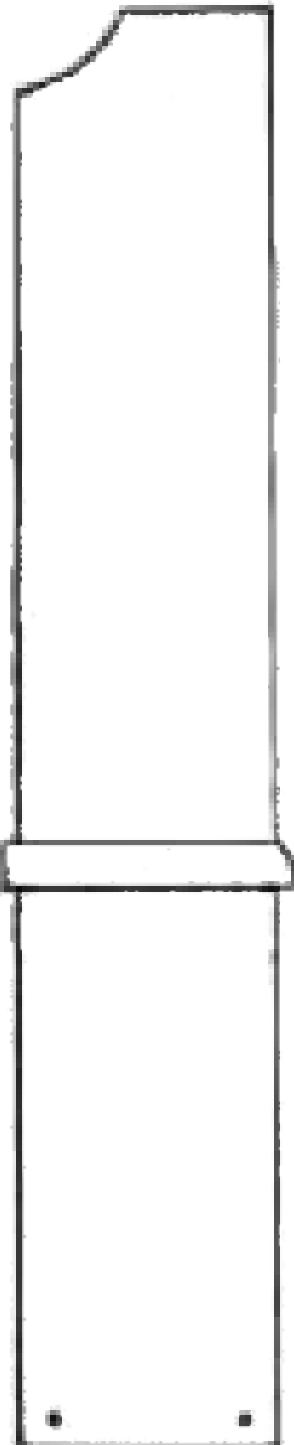

1 inches

A 18mm x 28mm steel strip behind base plate
retains lip assembly

.380 ACP / 9x18 Makarov magazine

Rather than hand winding a magazine spring, a 13mm wide, 2.5" long tension spring can be stretched out to form a very long compression spring suitable for use in such a small ID magazine.

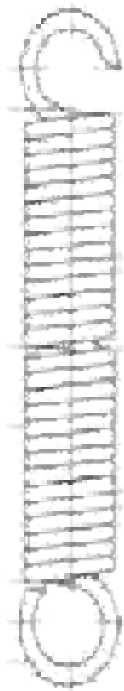

Hold both ends using pliers in each hand - stretch out until a substantial compression spring is formed. Strip both ends once complete.

A magazine spring produced in this manner will work reliably providing it is used in 30mm x 15mm tube sizes or smaller.

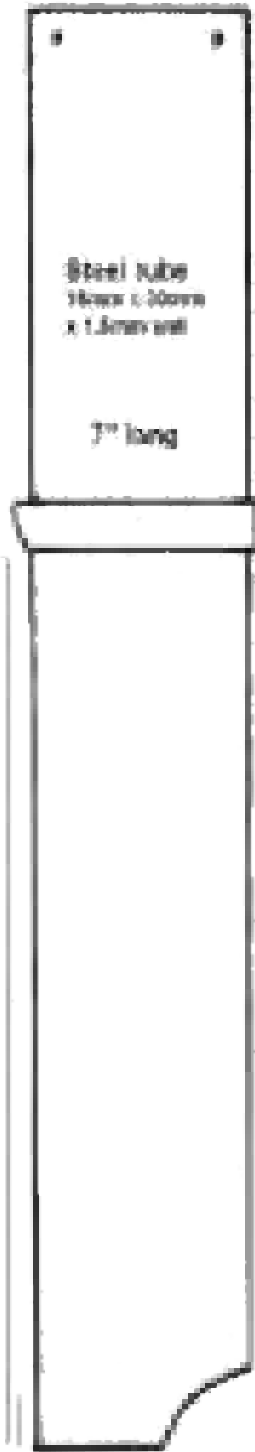

Base plate - 13mm x 17mm steel strip
- secure with two pins

Weld or epoxy a 2" long, 4mm thick steel strip to the upper half of the back of the magazine tube to fit in a magazine well made from 40mm x 20mm x 2mm tube.

File to ramp shape

17mm

Cut away a 3mm section from back

Follower

Band from 20mm long steel strip
16mm wide x 2mm thick



Band lips smooth evenly and both lips retain a cartridge - sand edges smooth

2 inches

Bolt (Tube body section)

The three piece bolt assembly is laminated together from a 4" long height of 25mm x 25mm steel square tube sleeved with a length of 20mm x 25mm to accept a 18mm diameter steel bar to serve as a bolt face.

The 25mm ID section of tube may need to be increased in outside diameter by lightly "spotting" some weld on each side and grinding down even until a tight fit is achieved. If available, 25mm x 2.5mm tube will be a better fit.

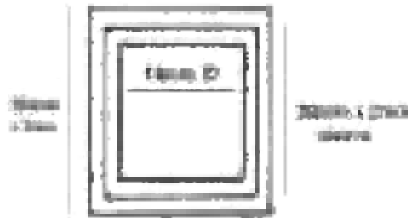

Bottom:

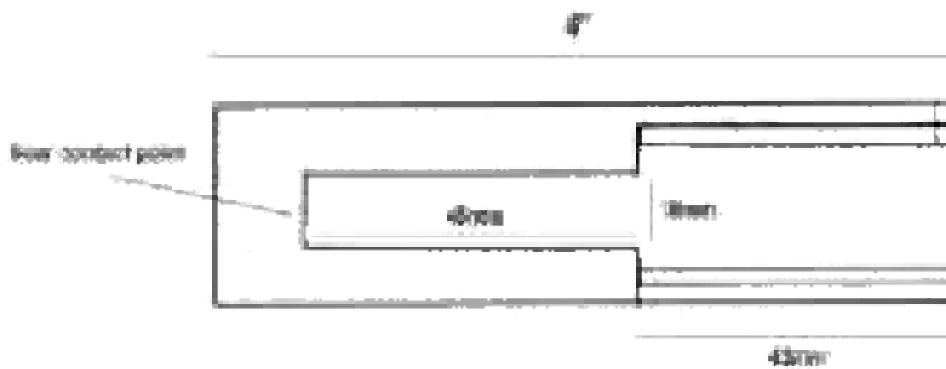

Left side:

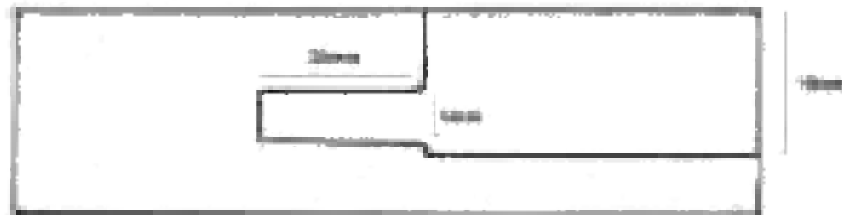

Right side:

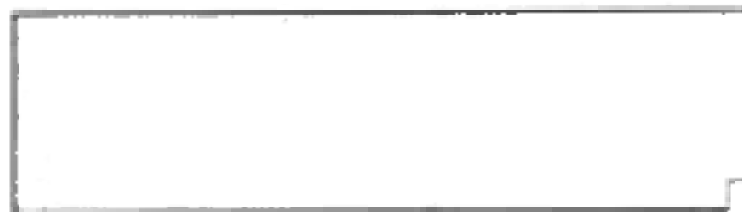

Cut a 2mm x 3mm square out of bottom corner to accommodate for head stop

3 inches

Bolt PL2

A 4" long section of 1/8" diameter mild steel bar stock serves as the inner section of the bolt.



- Drill the center with a 10mm drill bit with 5mm deep. Level the hole flat using a 10mm drill bit having had its tip removed using an angle grinder.
- Bevel the rim inwards slightly using a finer drill bit and sand smooth.



Using an angle grinder fitted with a 1mm cutting disc, make a 5mm long slot in the left side, 5mm deep.

Weight / cocking handle

A 3" by 1" rectangle cut from 6mm (1/8") mild steel plate serves as a cocking handle and adds additional mass to the bolt. Each plate will weigh around 100g.

Secure using two 1" long m5 bolts tapped into bolt and spaced through cocking handle slot with an m5 nut

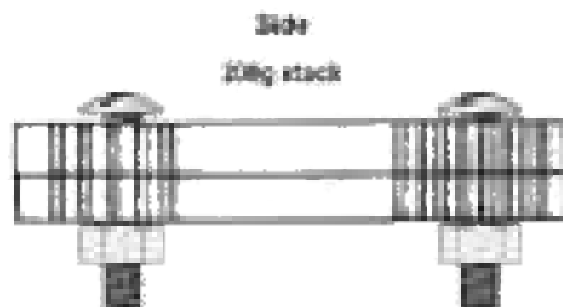
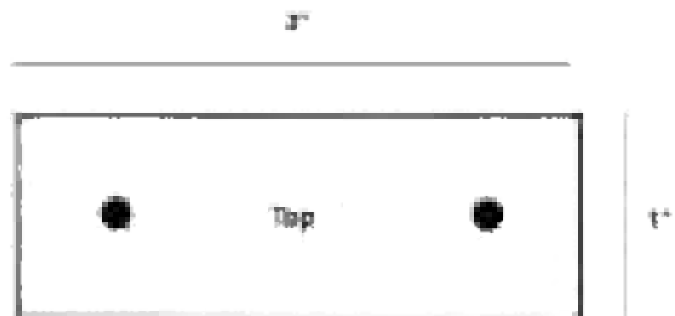

- Make serrations on sides using a hacksaw to improve grip

2 inches

Bolt (assembled)

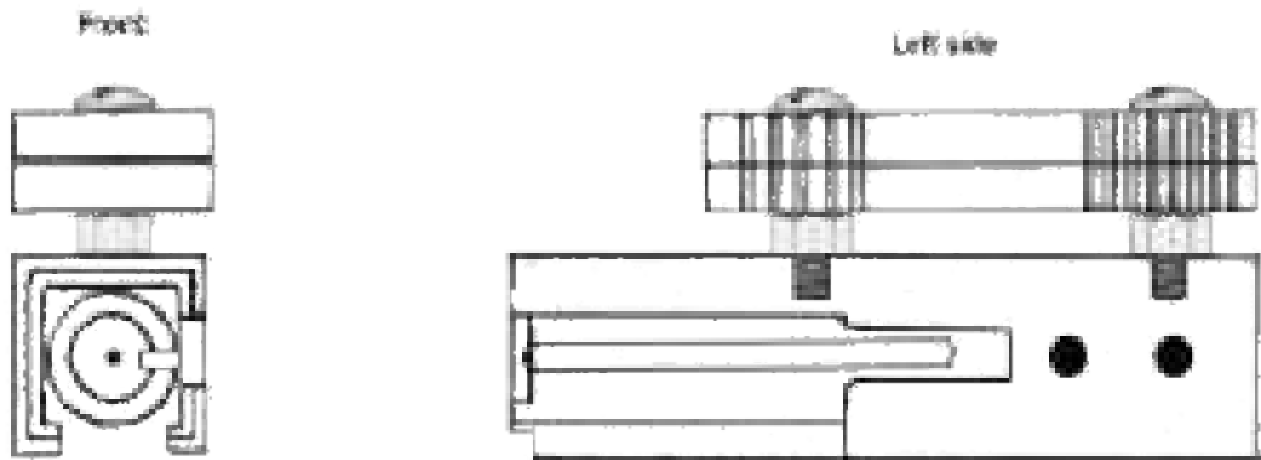

Secure inner bolt piece into carrier tube via two 4mm x 35mm steel pins. Alternatively drill and tap for two m6 grub screws either side. Weld in corners at rear to secure beforehand.

Back plug

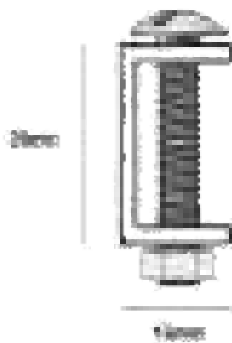

The back plug can simply be a 10mm length of 10mm diameter steel bar stock drilled for a bolt. Alternatively, a section of 20mm box section can be cut in half to serve as a plug. Sawn through receiver with a 35mm long m6 bolt + nut.

Recoil spring

2.34" (1.20mm)

Uncoiled purchased compression spring

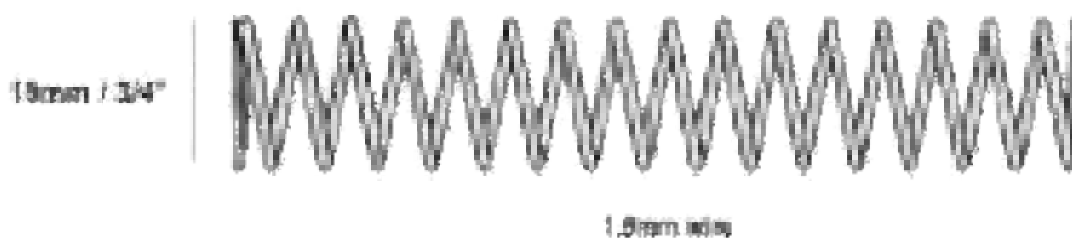

2 inches

Finish all components using a matt black, high temperature engine enamel type spray paint

2 inches

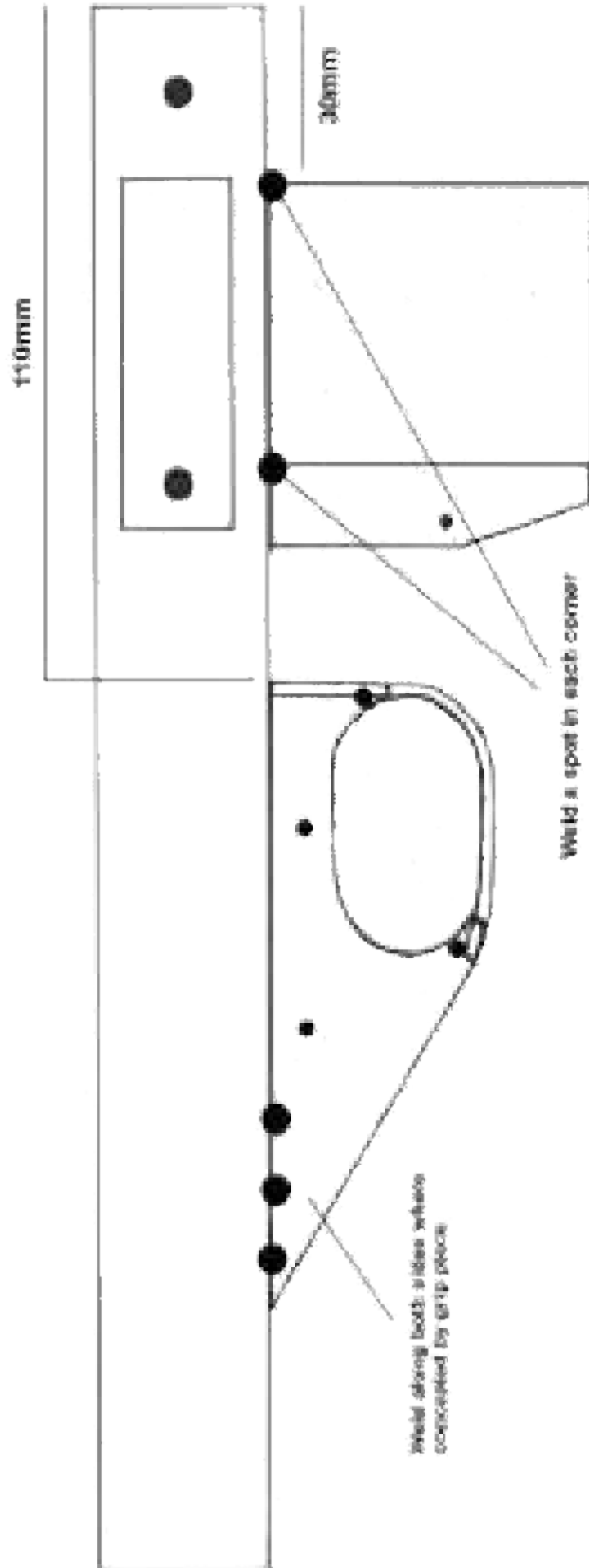

Grip

Carve from a single piece of 1/2" thick plastic or hardwood. Round off all edges.

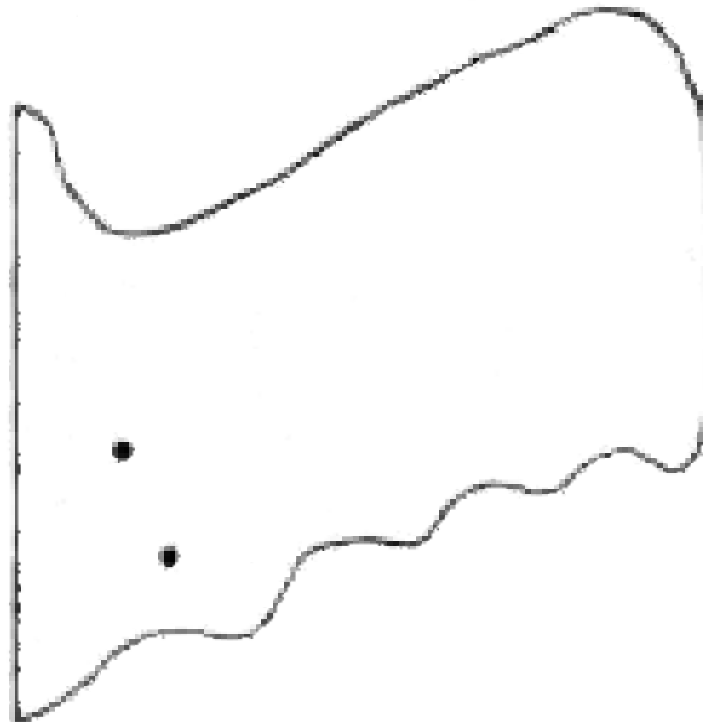

Use a combination of a hand saw and chisel to cut an 11mm wide slot into grip to match profile of trigger housing. Add a hole at points marked to seat bear spring correctly. Attach grip using two nut bolts passed through housing and threaded into one side of grip. Top should be flush against receiver allowing no movement. Reduce any wobble by applying wood putty or epoxy.

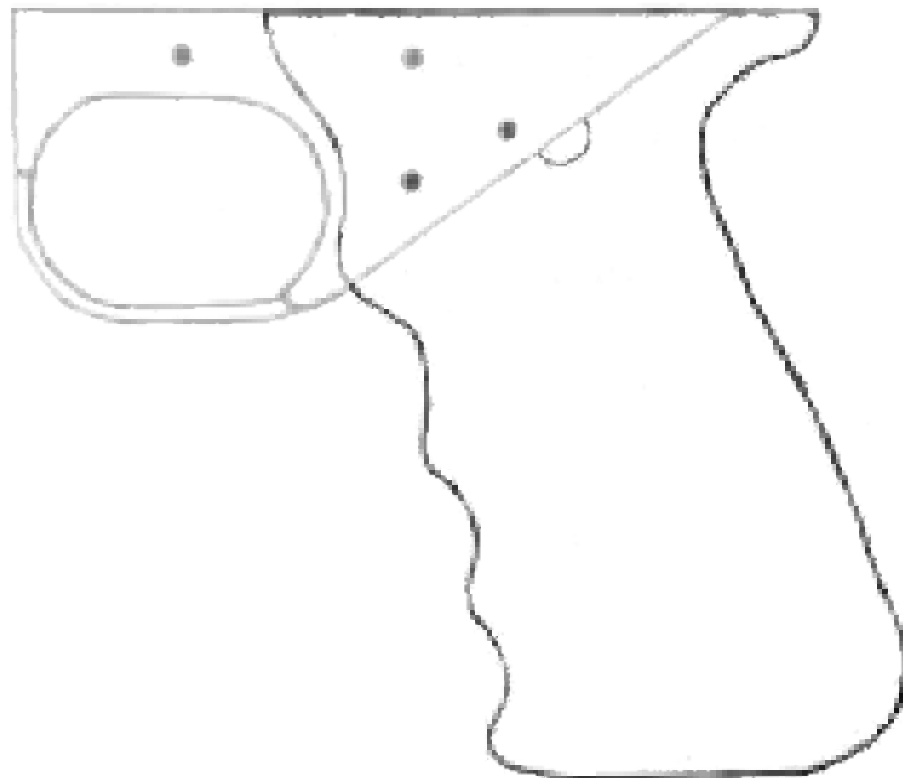

2 inches

Barrel assembly

Like the bolt, the barrel assembly is laminated from a length of 25mm x 2mm box tube sleeved with a length of 19mm x 1mm box tube. A 4mm deep cut is made leaving a protrusion for the feed ramp formed from both lower walls.

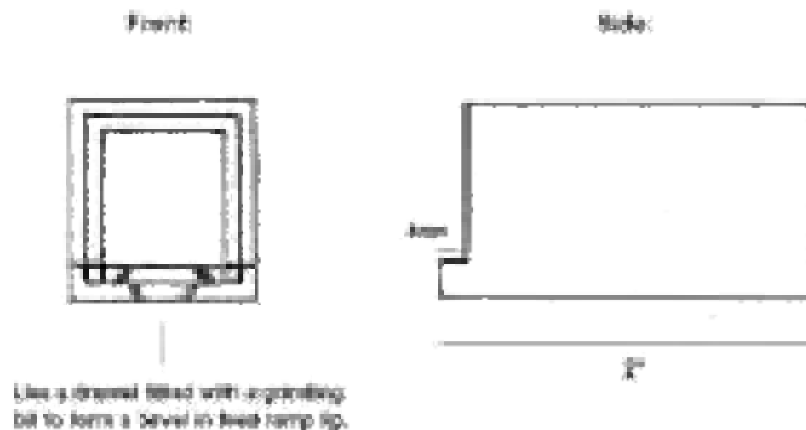

Use a 1/8" drill bit to create cone at mouth extending inside then very edges. Sand smooth.

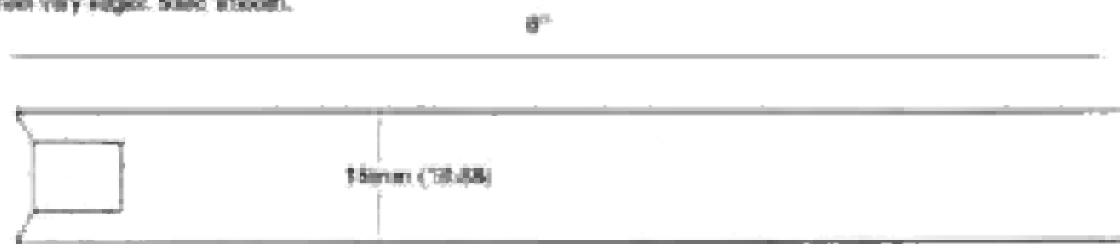

Two 6mm x 25mm sealock pins can be used to retain barrel in collar. Alternatively weld in place.

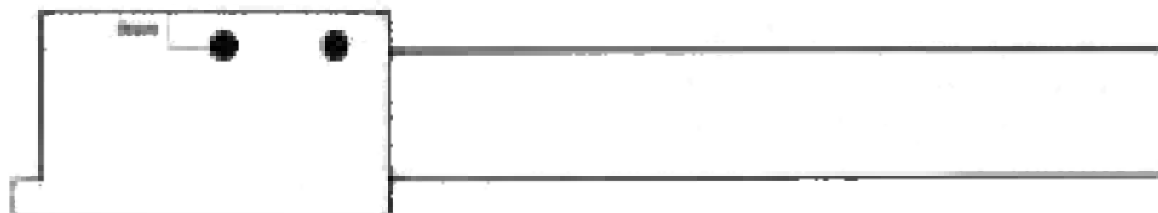

For legal purposes destroy during barrel and weld in place

2 inches

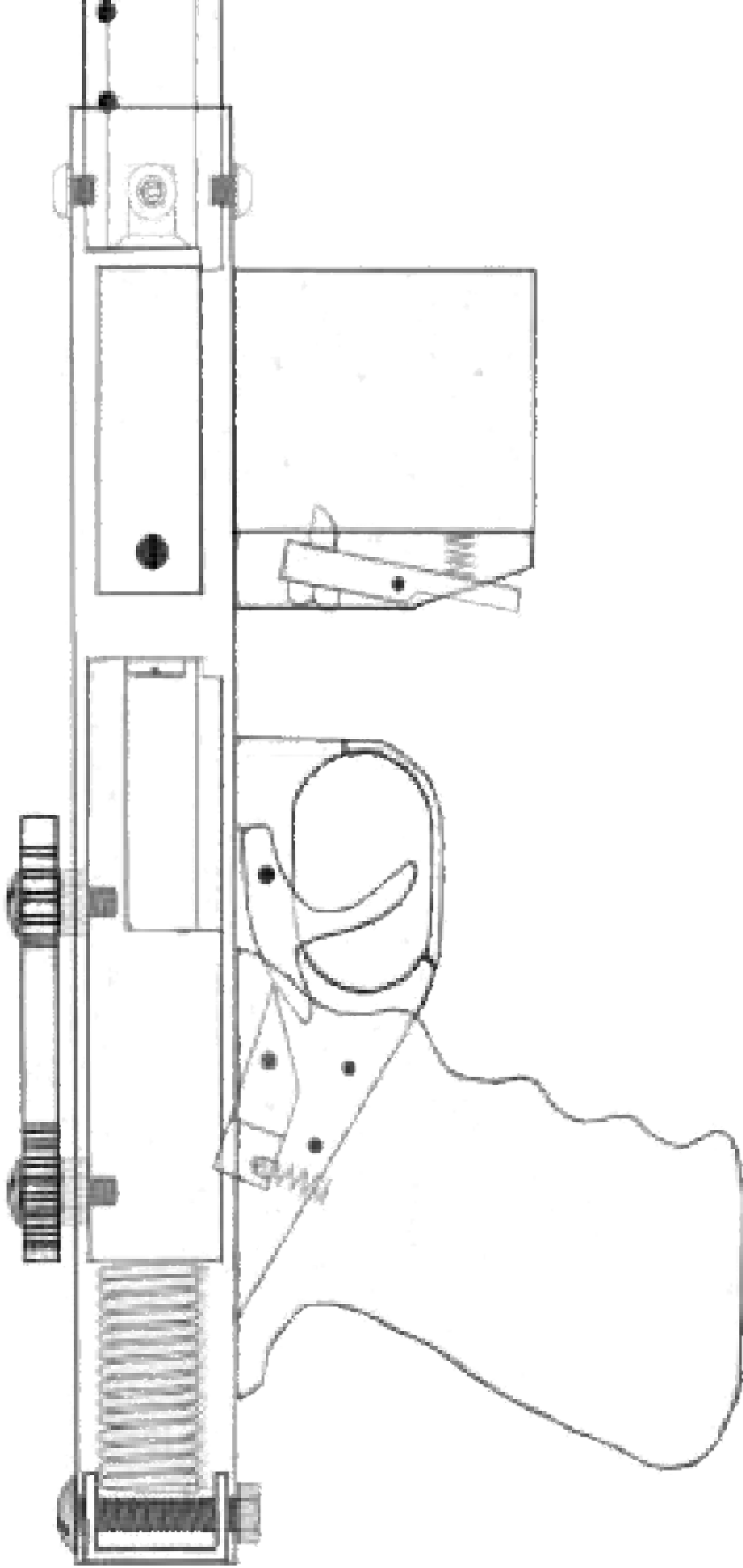

Σ. Ιωάννης

The MAC-10 Construction Guide

Practical Scrap Metal Small Arms Vol.6





Introduction

Detailed herein are plans for a 1:1 copy of the MAC-10 submachine gun, the only differences being the internals having been simplified for ease of home manufacture. For readers familiar with The Box Tube MAC-11 design described in Vol.2 & 5, the construction techniques and tools used in this project are very similar. The design described here is slightly less expedient, though what results is a highly accurate reproduction of the original weapon which will match many factory made examples in quality if care is taken. As before, no lathe or milling machine is needed and only very basic tools are required for construction.

*For legal reasons, the demonstration model pictured was built as a non-firing dummy replica. It contains a permanently destroyed dummy barrel which is welded in place, drilled and blocked with several hardened steel inserts as well as it's bolt having no provisions for a firing pin. **This document is intended purely for academic study purposes only.***



Destroyed dummy barrel of demonstration model

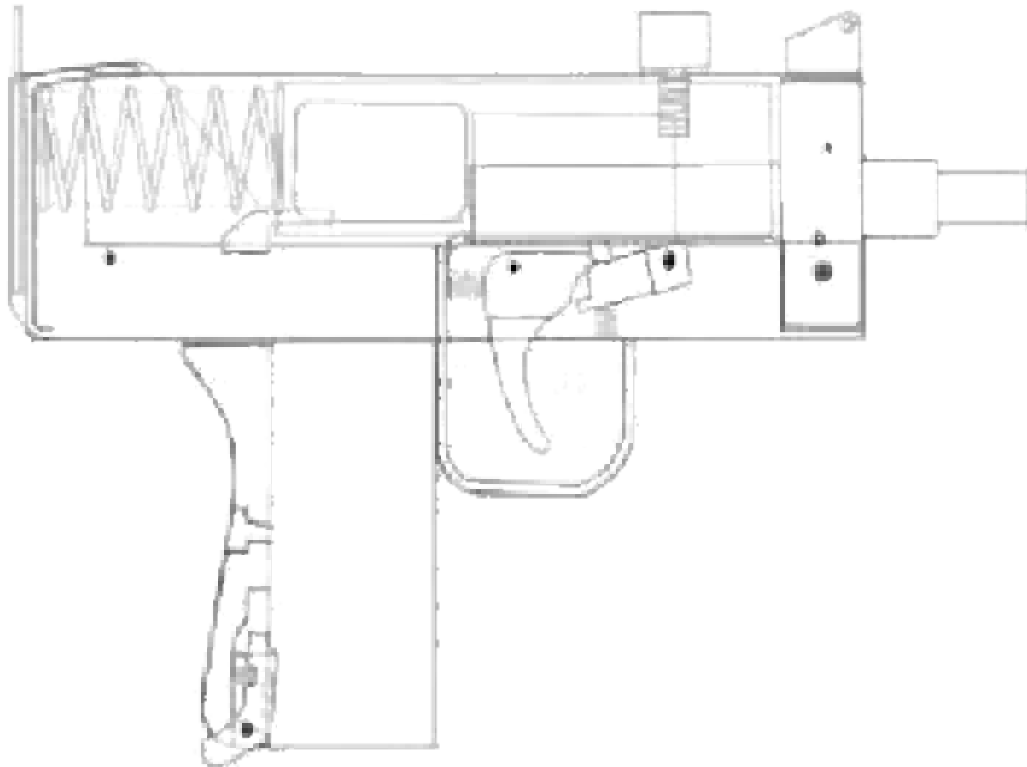

Useful Tools

Angle grinder
Hacksaw + cobalt tipped blades
Cobalt or titanium tipped drill bits
Drill press or hand drill combined with a stand
Welder
Dremel / rotary tool + reinforced cutting discs
Hand files

Materials

2mm or 2.5mm thick mild steel plate
38mm x 38mm x 1.5mm steel box section
1" x 2" (25mm x 50mm) steel box section
30mm x 30mm x 2mm steel box section
1" (25mm) mild steel bar
10mm aluminum plate
5/8" (16mm) steel bar or tube

Overview of components and their construction

Lower receiver



The lower receiver is constructed of plates cut from 2mm or 2.5mm steel sheet. It consists of a lower plate, bent twice at the rear to form a closure with two plates welded to either side. The lower plate has cuts made into it to accommodate passage of the magazine and trigger. Once welded together, four holes are drilled through each side plate. The trigger guard / feed ramp combination is cut out from a strip of steel sheet after which it is bent to the specified dimensions and welded in place.

Upper receiver



The upper receiver is simply a length of 38mm (1 1/2") aluminium or steel box section tubing with a wall thickness of 1.5mm (16 swg) into which the ejection port, cocking handle slot and lower opening are cut out using either a dremel type rotary tool fitted with a 'reinforced cutting disc' or by drilling a series of holes then chiselling the excess out before filing smooth.

Magazine-well

The magazine-well is made from a section of modified 1" x 2" (25mm x 50mm) steel box section, shortened to 25mm x 43mm by removing, slightly widening out, then re-welding on one side until able to accept a STEN magazine. The magazine catch is cut out from 10mm thick aluminium plate, it's housing consisting of a small piece of bent sheet steel welded in place. The back grip piece is cut out from either wood or plastic and is drilled to attach it via a short m5 bolt threaded shallowly into the magazine-well.



Bolt carrier assembly

The bolt carrier is constructed from a length of 30mm steel square box section tube onto which both the sides and top are increased in outside diameter using 2mm steel plate welded in place to match each side's respective profile. The final dimension of the finished bolt carrier should be 34mm, which is the correct dimension for functioning inside the upper receiver.



Bolt piece



Inert dummy example containing no firing pin

The bolt piece is made from a 50mm long section of 1" diameter steel bar stock which is 'machined' to shape using a drill, hand files and a small angle grinder. If cutting to length from a longer piece of bar, a series of holes can be made along the desired point using a 3mm drill bit after which an angle grinder fitted with a 1mm cutting disc can be used to finish the cut without needing to resort to a hacksaw.

The breech face of the bolt is first drilled using a 10mm drill bit for 3mm deep, then levelled flat using the same drill bit but with the tip having been removed to create a flat grinding bit. The feeding cuts for the magazine are carefully formed using a small angle grinder fitted with a 3mm grinding disc then hand finished using a file.

Finally, a slot is made to it's side which accommodates passage of the ejector, allowing a cartridge to be 'flicked' out of the ejection port. The extractor is cut out from 3mm steel plate and retained using a 3mm pin with a small spring providing tension. Once the bolt piece is finished it can be pinned inside the carrier using four m8 grub screws or steel bars along each side allowing any needed adjustments prior to optionally welding it in place.

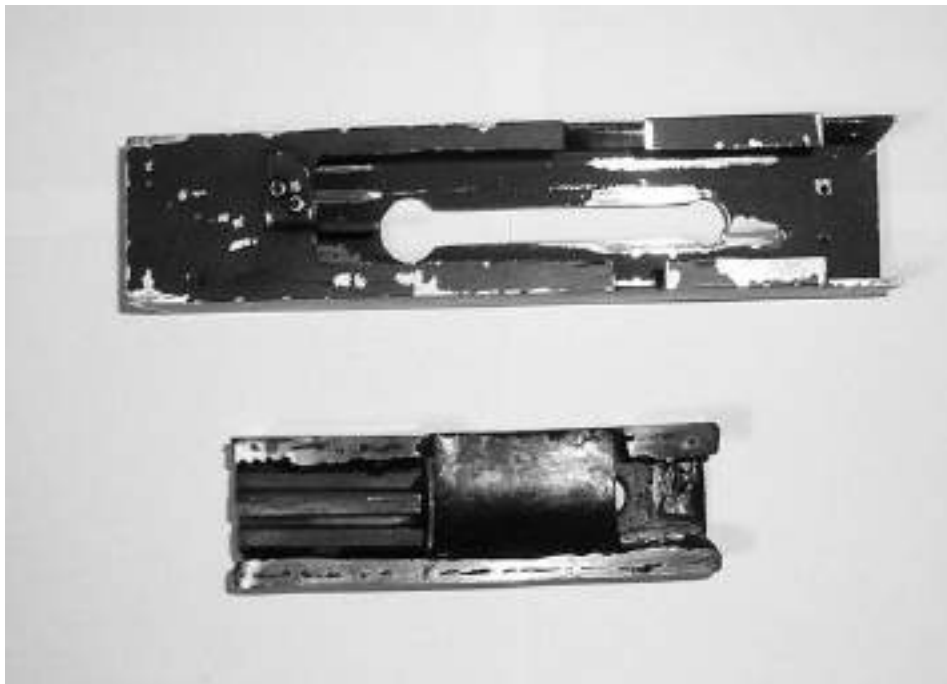

Finished bolt and upper receiver with ejector bolted to underside.

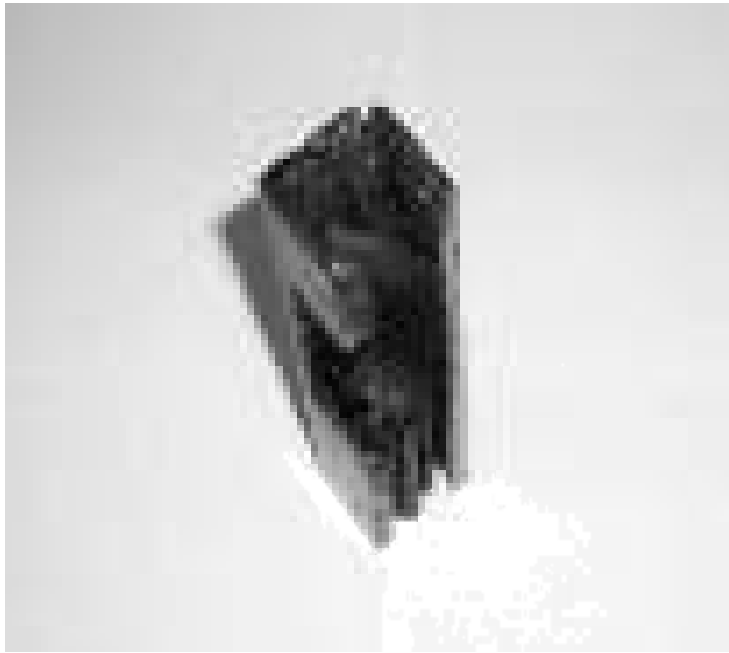

When assembled the bolt weighs almost 550g. If further weight is desired, a section of steel sheet can be welded to the inside of the carrier offering a convenient container for filling with more material and sealing with weld. The bolt piece itself can also be drilled with a 3/8" (9.5mm) bit to accept standard 3oz (85g) tungsten weights, each 12mm in length.

The cocking handle is made from an m10 bolt threaded into place, optionally modified in diameter using a ring of 19mm x 1.5mm tubing to improve ergonomics.

Trigger group

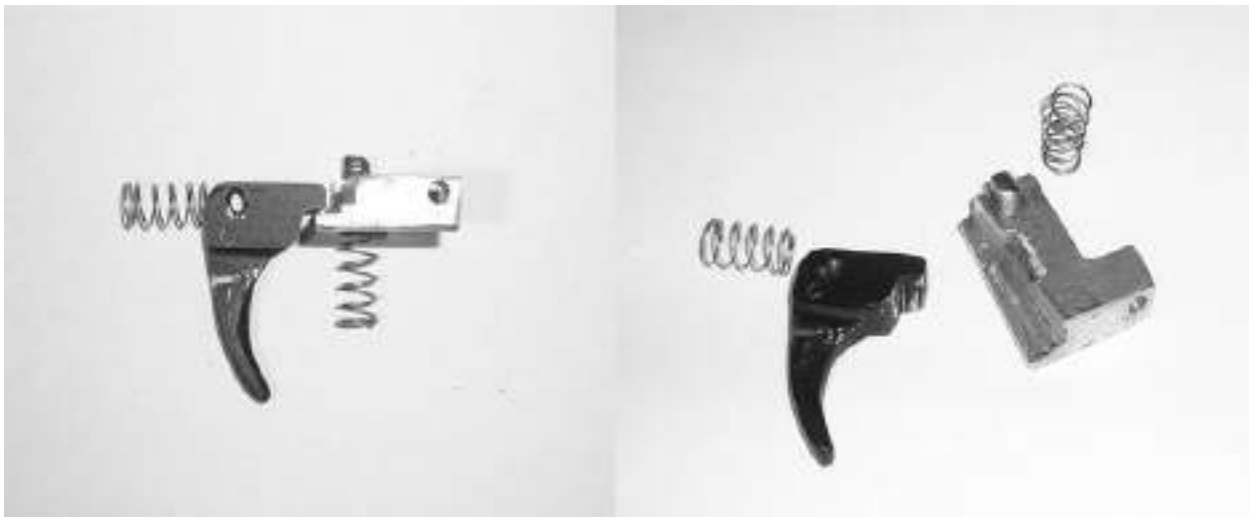

The trigger group is a very simple arrangement which allows the bolt to move forward under spring pressure when the trigger is pulled or stay cocked back behind the sear when the trigger is released. Both components are cut from 10mm thick aluminum (easier to cut) or steel plate. The contact surface of the sear is provided by way of an m8 bolt tapped into place which is then filed to it's correct shape. Compression springs which are ideal for use can usually be found by opening up the pump of a hand sanitizer or shampoo bottle.

Recoil Spring



A suitable recoil spring can be obtained from a lever type grease gun. The compression spring inside may need to be weakened by heating slightly and rapidly slamming to acquire the right amount of tension or by cutting off a number of coils. The spring used here measures 6.5" long, 30mm wide and is wound from 1.5mm diameter wire.

Finishing

High temperature engine enamel type sprays offer a very durable means of finishing each component and require little preparation and usually no priming. If used on aluminum, most spray finishes will not bond as reliably as they will on steel. Anodizing or parkarization may be employed if a higher quality finish is desired.

Plans

All pages included should be printed out on 8.5 x 11 US letter paper. Each component template is drawn to scale and can be cut out and glued to their respective thickness of material or used as reference for measurements. Make sure the ruler at the bottom left of each sheet is 2 inches in length. Alternatively, take a screen- shot and enlarge the plans using a computer program until the ruler is the correct length, then trace the parts needed onto a sheet of paper taped over your computer's screen.

Lower receiver templates

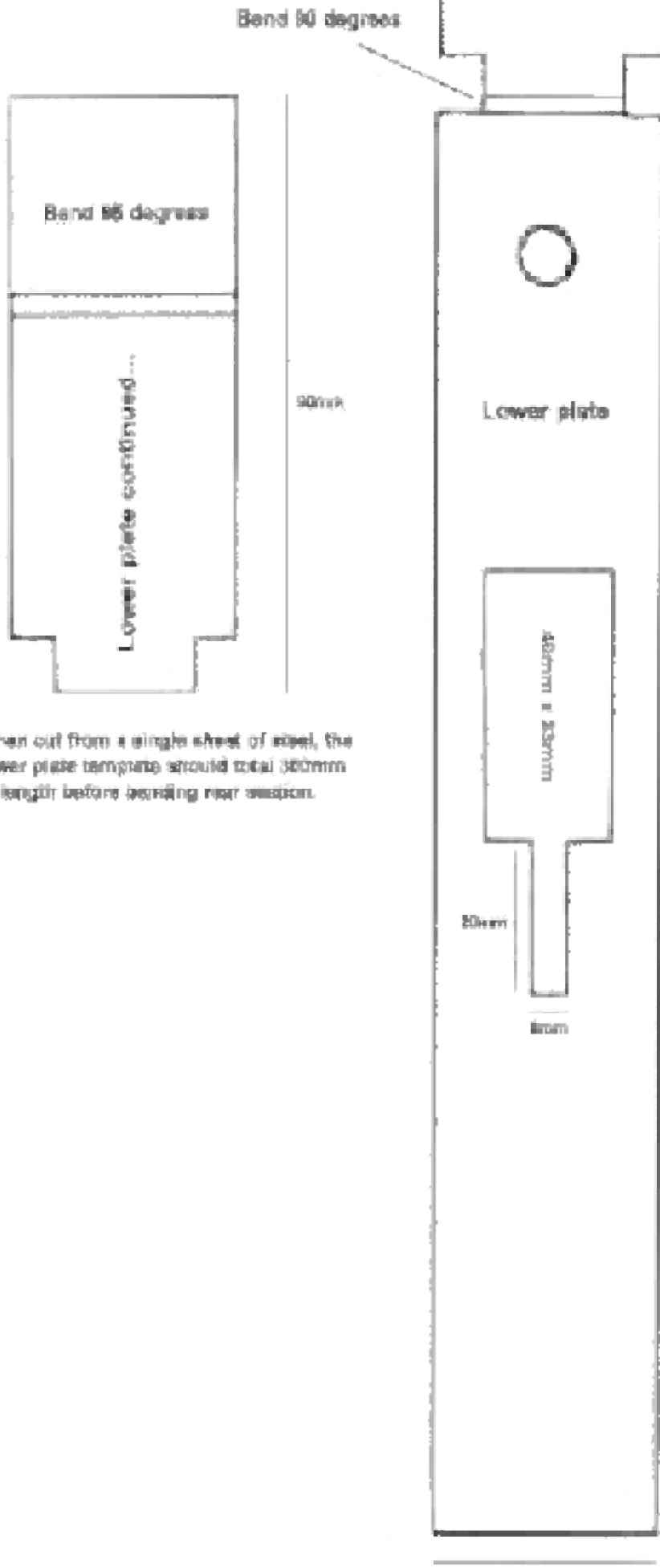

When cut from a single sheet of steel, the lower plate template should total 380mm in length before bending rear section.

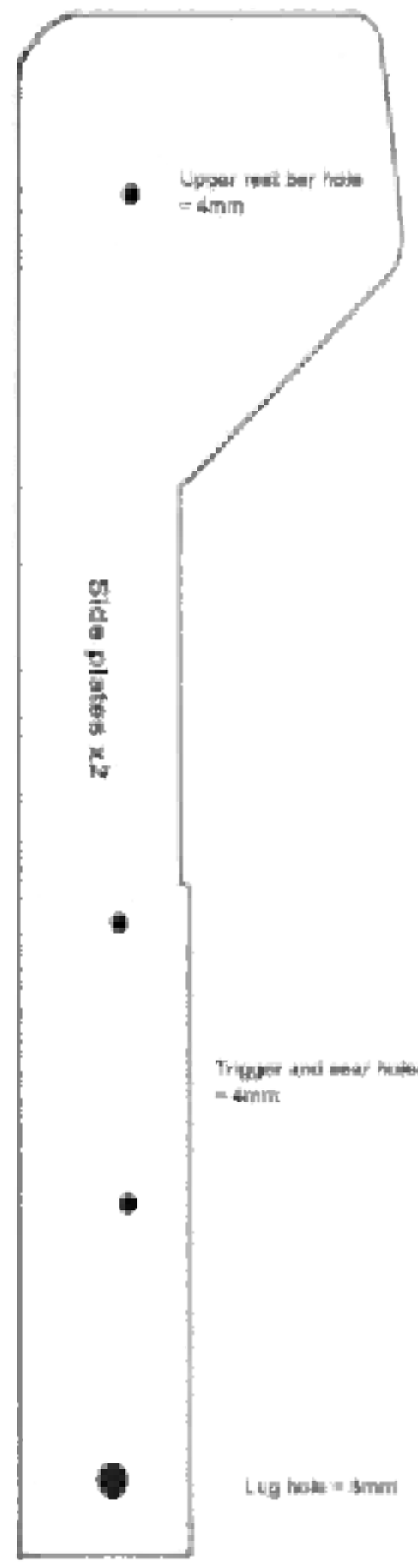

2 inches

10mm

Rear assembly

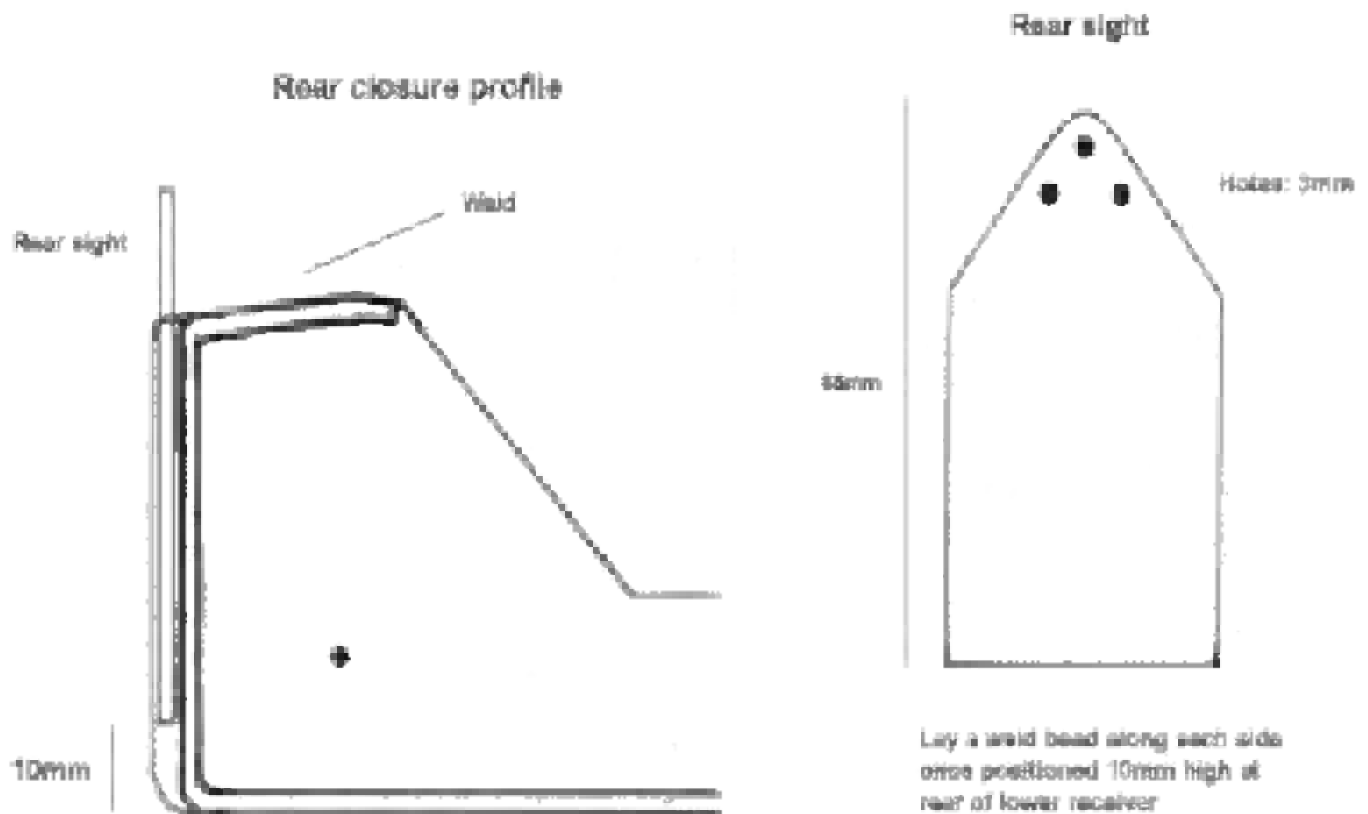

Welding lower receiver plates together

Position side plates and lower plate together using clamps, leaving a slight 'trench' between contact points to allow for adequate weld build up. A section of 38mm box tubing can be used as a jig.

Pointing down, lay a continuous weld bead along each side. Grind off excess weld and smooth over using an angle grinder fitted with a 3mm grinding disc.

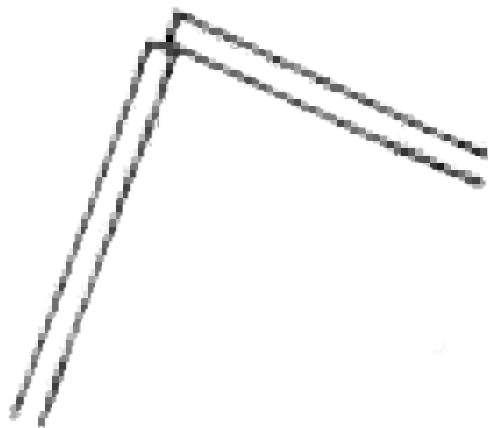

2 inches

Trigger guard / feed ramp

Template

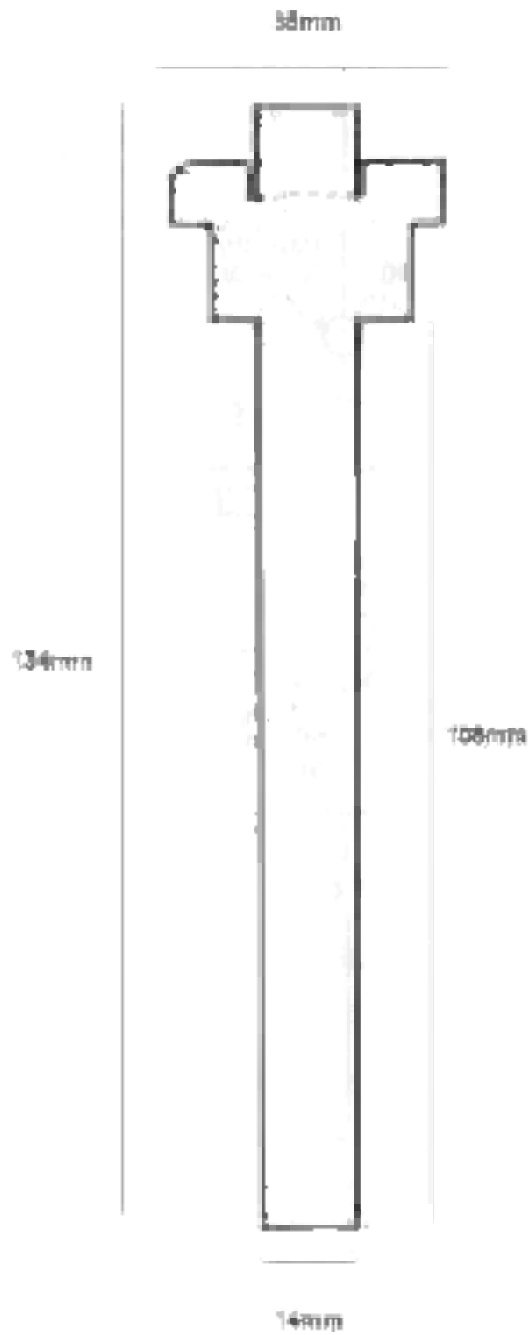

Finished profile

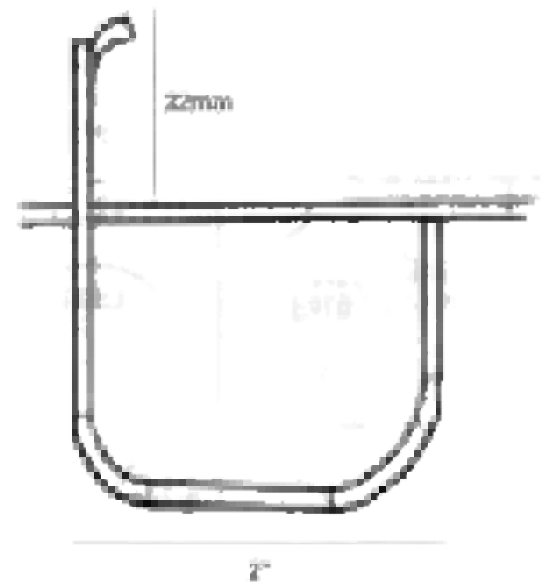

2 inches

Magazine-well

The Magazine-well is created by removing a 1" side from a length of 1" x 2" steel box section, after which the back is widened out slightly to accept a STEN magazine. The removed portion of well is then welded back into place forming the correct inner dimension.

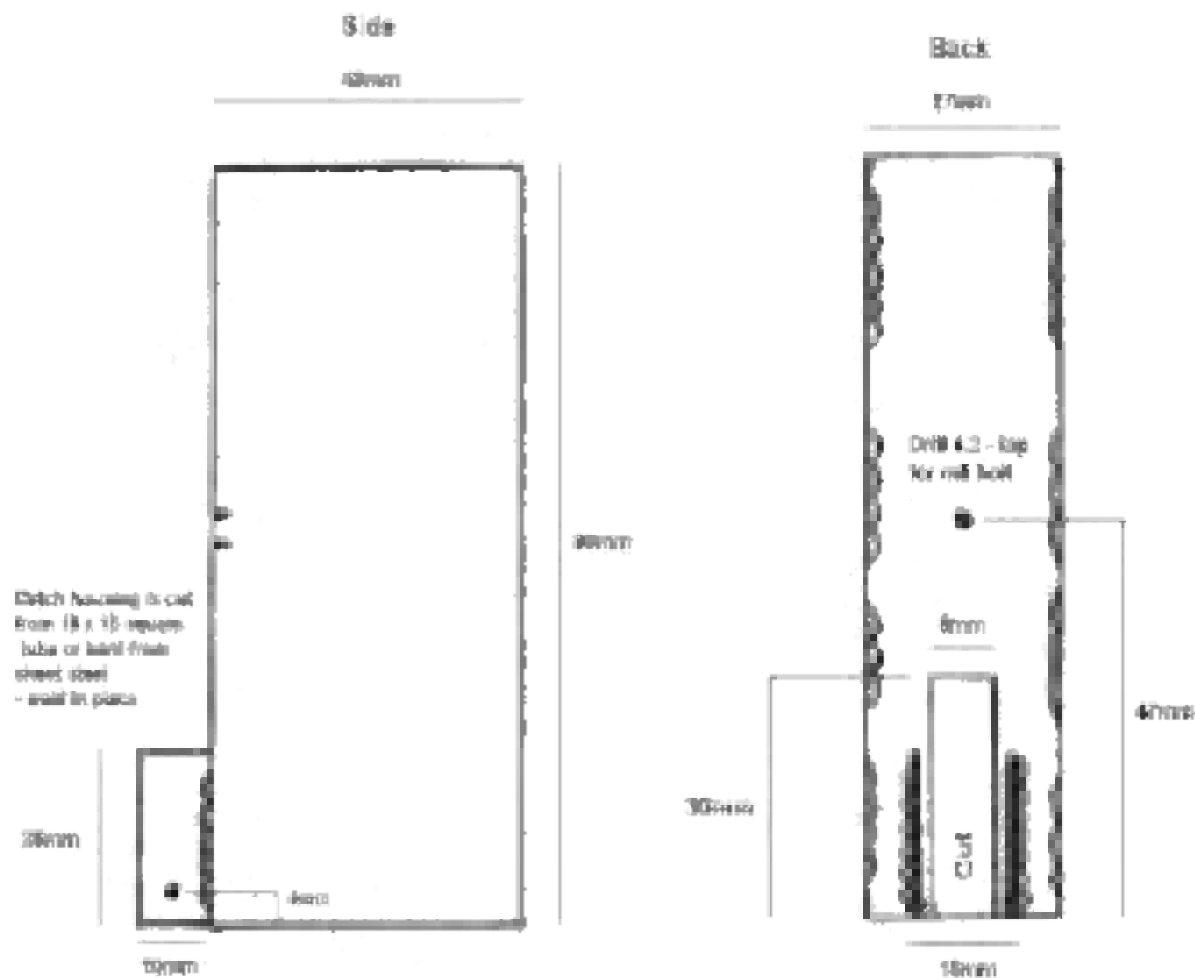

Mag catch

Grip

1" thick wood or plastic

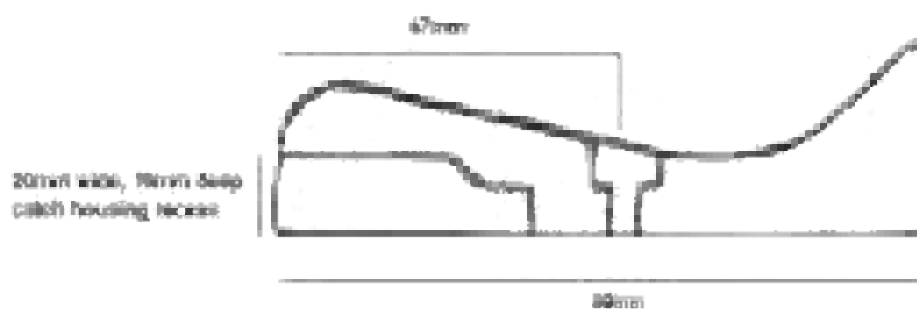

2 inches

Print on 8.5x11 US letter paper

Magazine-well : 1" x 2" (25mm x 50mm x 1.5mm) mild steel box section

Catch housing : 1.5mm mild steel sheet or 15mm box section

Catch : 10mm thick aluminum plate

Grip : 1" thick hardwood or plastic

Right side

198mm

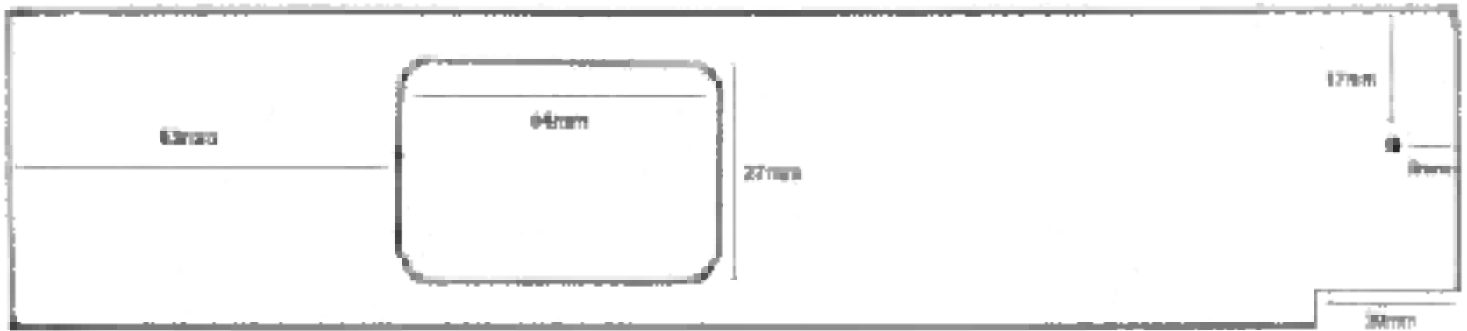

Top

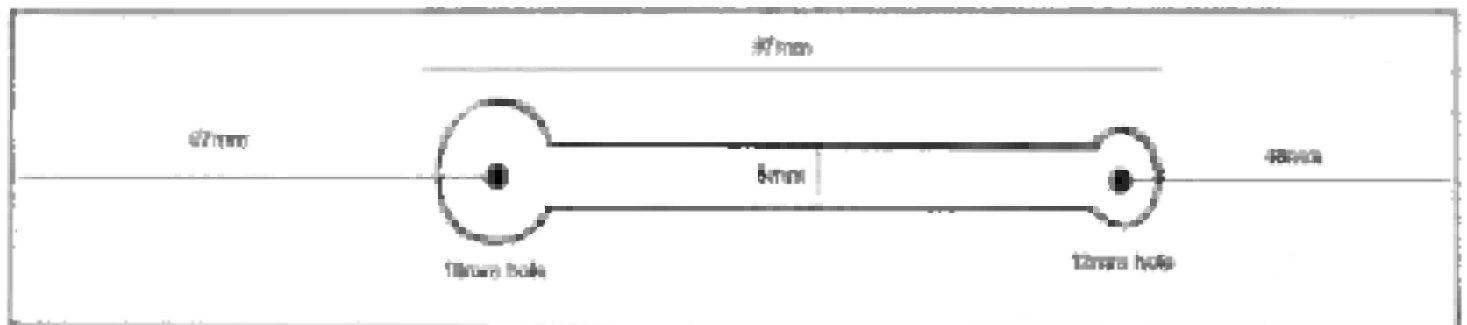

Left side

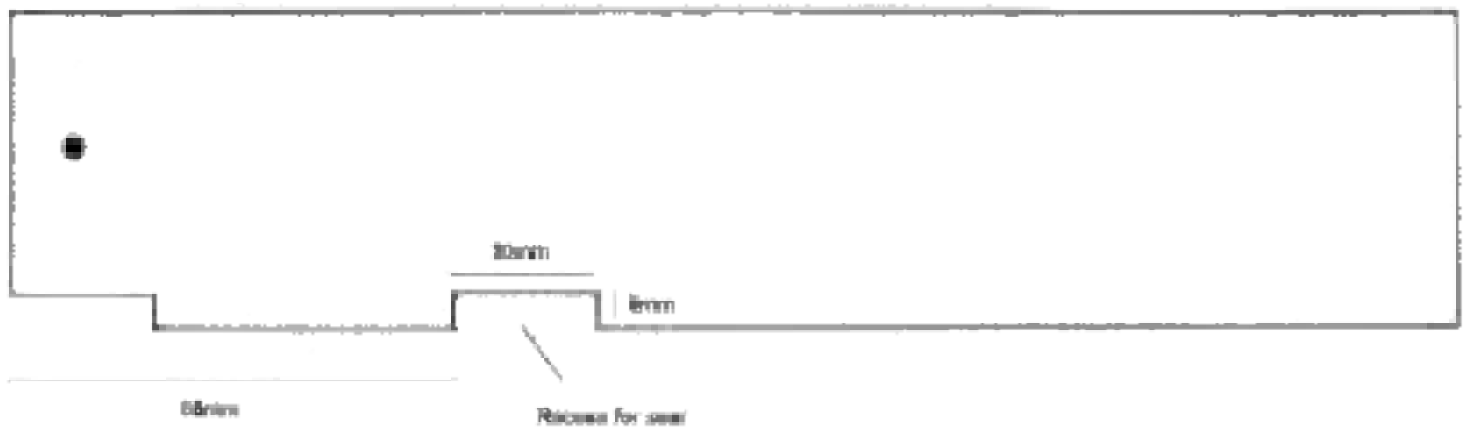

2 inches

Upper receiver

Bottom

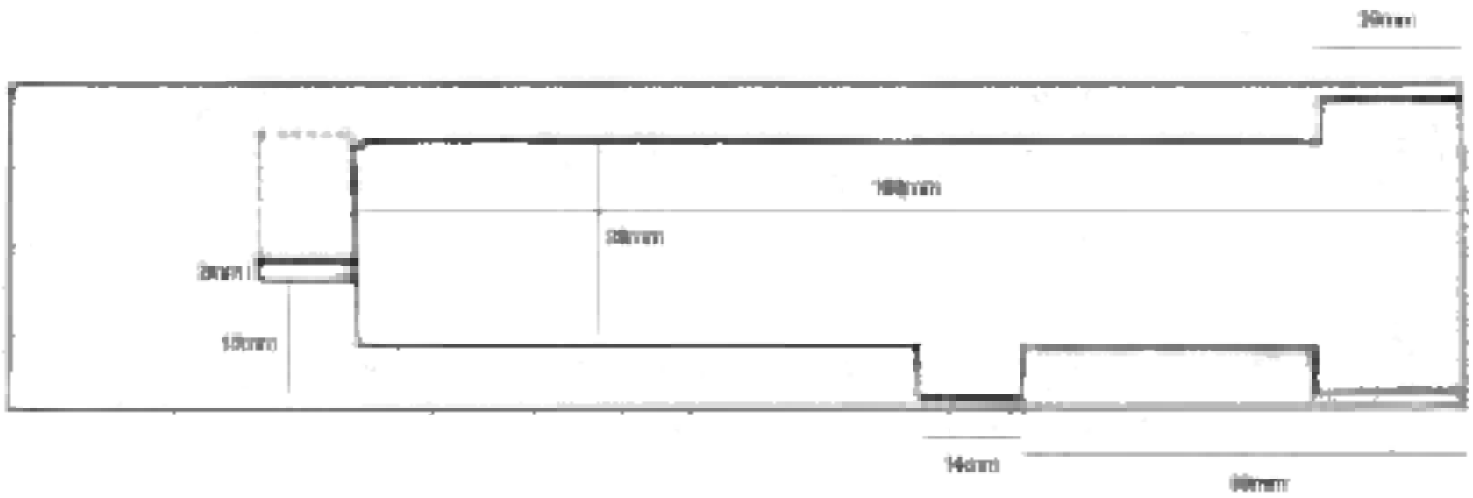

Front sight

Ready from a section of 25mm box tubing or band from 2mm thick sheet

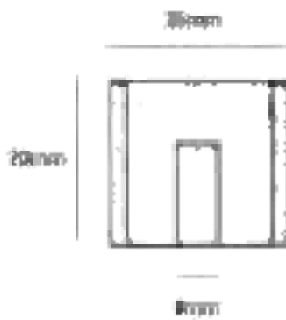

Slot middle and raise until fibres high to form sight blade

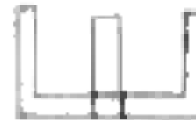

Ejector

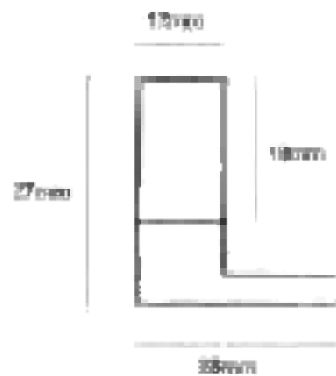

Finished profile

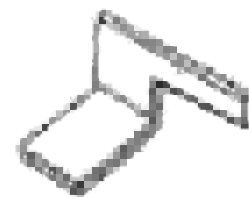

Secure through receiver slot using two bolts or wedges

2 inches

Print on 8.5x11 US letter paper

Front sight : 25mm mild steel box section or 2mm thick sheet
Ejector : 2mm mild steel sheet

Trigger group

Assembled:

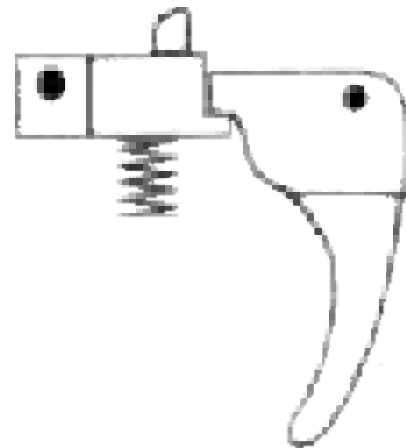
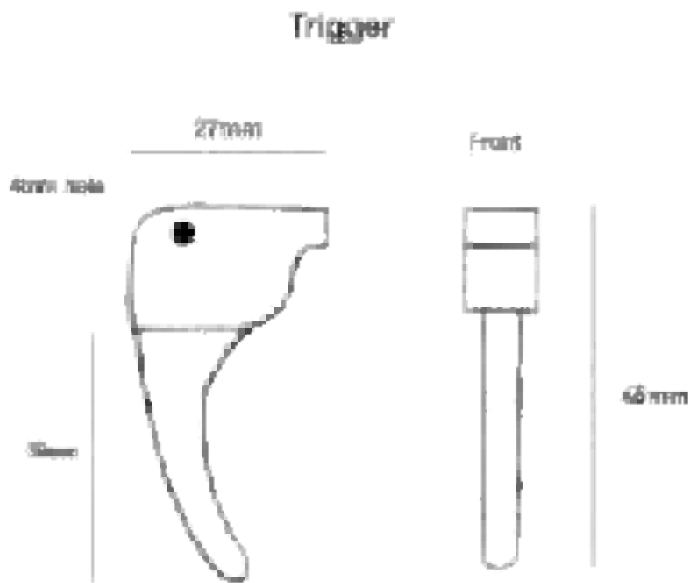

Sear

Drill sear tooth hole 7mm and tap for an M3 bolt. Cut off bolt so protruding 3mm high and file to shape to create sear tooth.

Top

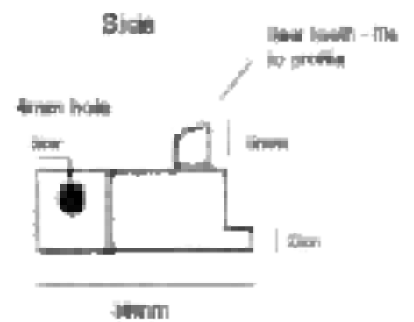
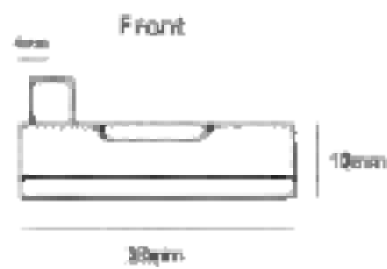
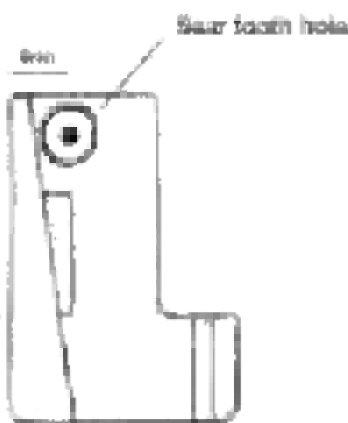

File down area for trigger to contact

2 inches

Print on 8.5x11 US letter paper

Trigger and sear : 10mm thick aluminum plate
Sear tooth : M3 bolt

Bolt carrier

inner bolt carrier - 30mm x 30mm x 2mm box section

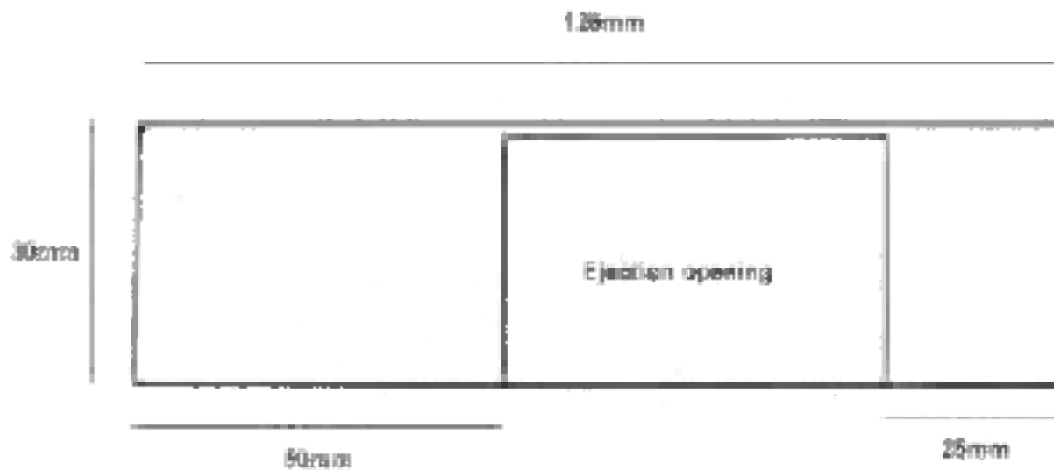

Side plates x 2

(Left side plate has no ejection opening)

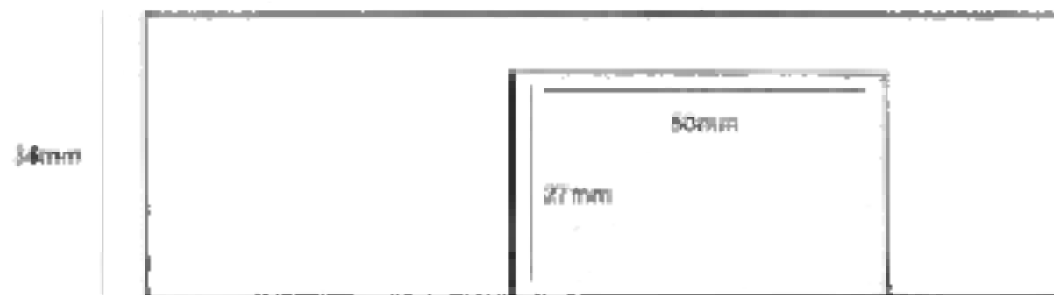

Top plate

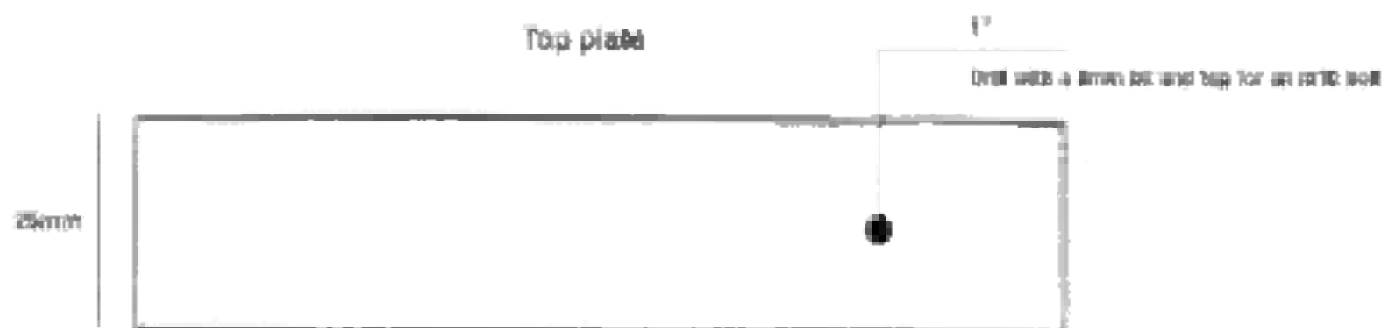

2 inches

Print on 8.5x11 US letter paper

inner box : 30mm x 30mm x 2mm mild steel box section
Bolt carrier plates : 2mm mild steel sheet

Bolt piece

50mm long 1" dia mild steel bar

Breach face



Mark a point 10mm below top. Drill with a 10mm drill bit for 3mm deep and level off with a beheaded 10mm bit to create a flat surface. Bevel edges slightly using a 10mm+ drill bit or dremel grinding tool. 2mm of material should remain below the hole to serve as a feed lip.

Completed:



Grind down feeding cus using an angle grinder fitted with a 10mm or 16mm grinding disc. Finish with a hand file.

Bit 5mm deep using an angle grinder fitted with a 10mm grinding disc. Finish with dremel if necessary.

Bottom

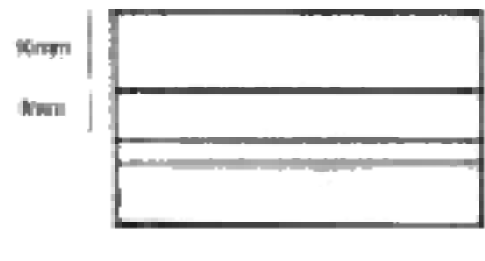

50mm

Extractor



Hand fit using a cartridge as a guide. Position extractor pin hole on bolt 11mm from front. Drill a 3mm hole to accept it's spring 25mm from front.

- Heat until cherry red and quench in motor oil to make-shift harden.

2 inches

Print on 8.5x11 US letter paper

Bolt piece : 1" (25mm) mild steel bar stock
Extractor : 2.5mm or 3mm steel piece

Bolt (assembled)

Weld in place or secure bolt piece inside carrier using three or more 25mm long 8mm dia steel bars or three mill grub screws lapped into each side.



Weld top and side plates to inner tube along exposed edges. Grind excess weld smooth. Side plates should be positioned flush with bottom.

Bolt carrier front view:

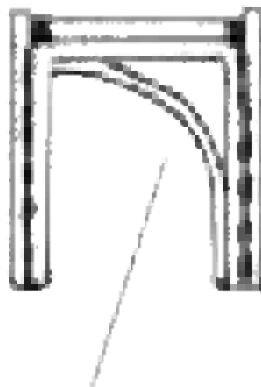

A 40mm x 50mm section of steel sheet can be bent and welded inside to hold additional weight behind it. This also acts as cocking handle stop.

- Alternatively a 10mm steel bar can be welded in it's place

Cocking handle

15mm long m10 bolt

File down dia of top to 10mm wide to fit through cocking handle slot

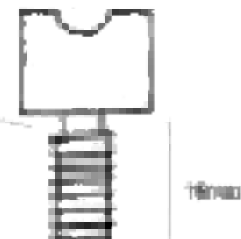

Secure a 120mm long section of 10mm x 1.5mm steel tube over bolt head using epoxy or silver solder. Slot top to allow function of sights.

Recoil spring:

- 5.6" long
- 30mm outer dia
- 1.8mm dia wire

A compression spring taken from a lever type grease gun should be suitable (May need to be shortened or weakened).

2 inches

Barrel assembly

Trunnion

20mm thick aluminum / steel block or two 10mm thick pieces bolted together

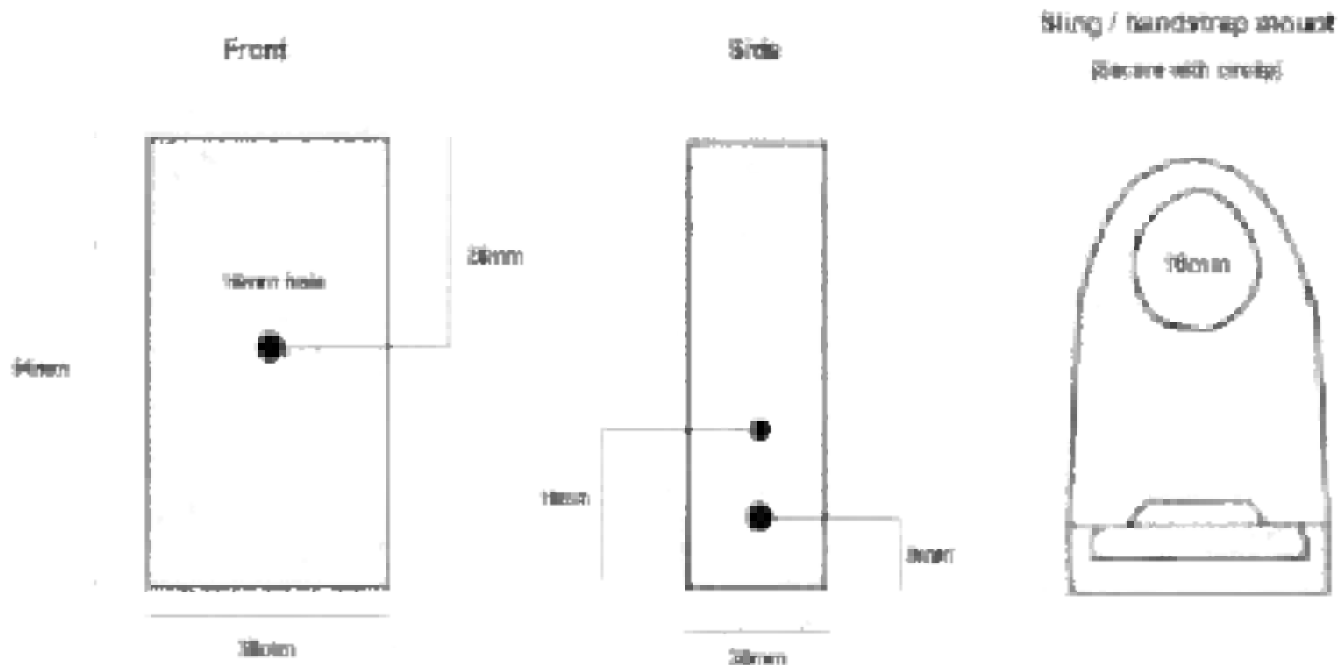

Sheet metal strip

20mm wide, 1.5mm thick

(used into front of lower receiver)

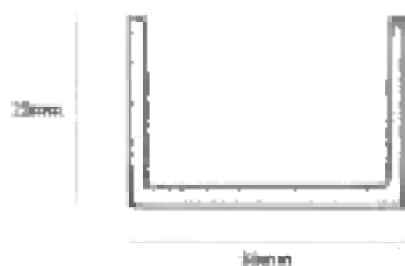

Barrel (dummy)

100mm long, 16mm (5/8") wide

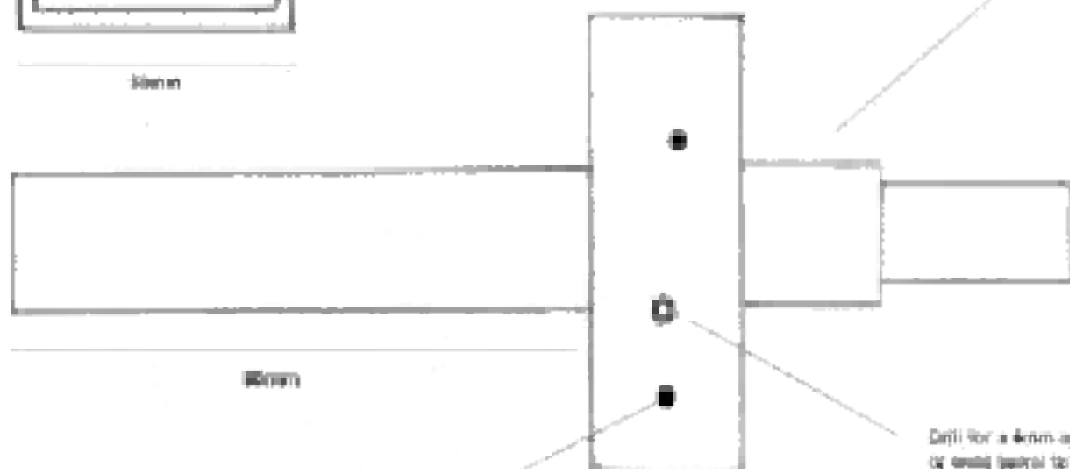

Position in lower receiver before drilling and tapping for an rail bolt each side

2 inches

Print on 8.5x11 US letter paper

Trunnion : 20mm aluminum or steel block
Handstrap mount : 2mm mild steel sheet
Dummy barrel : 16mm bar or tube

STEN magazine modifications

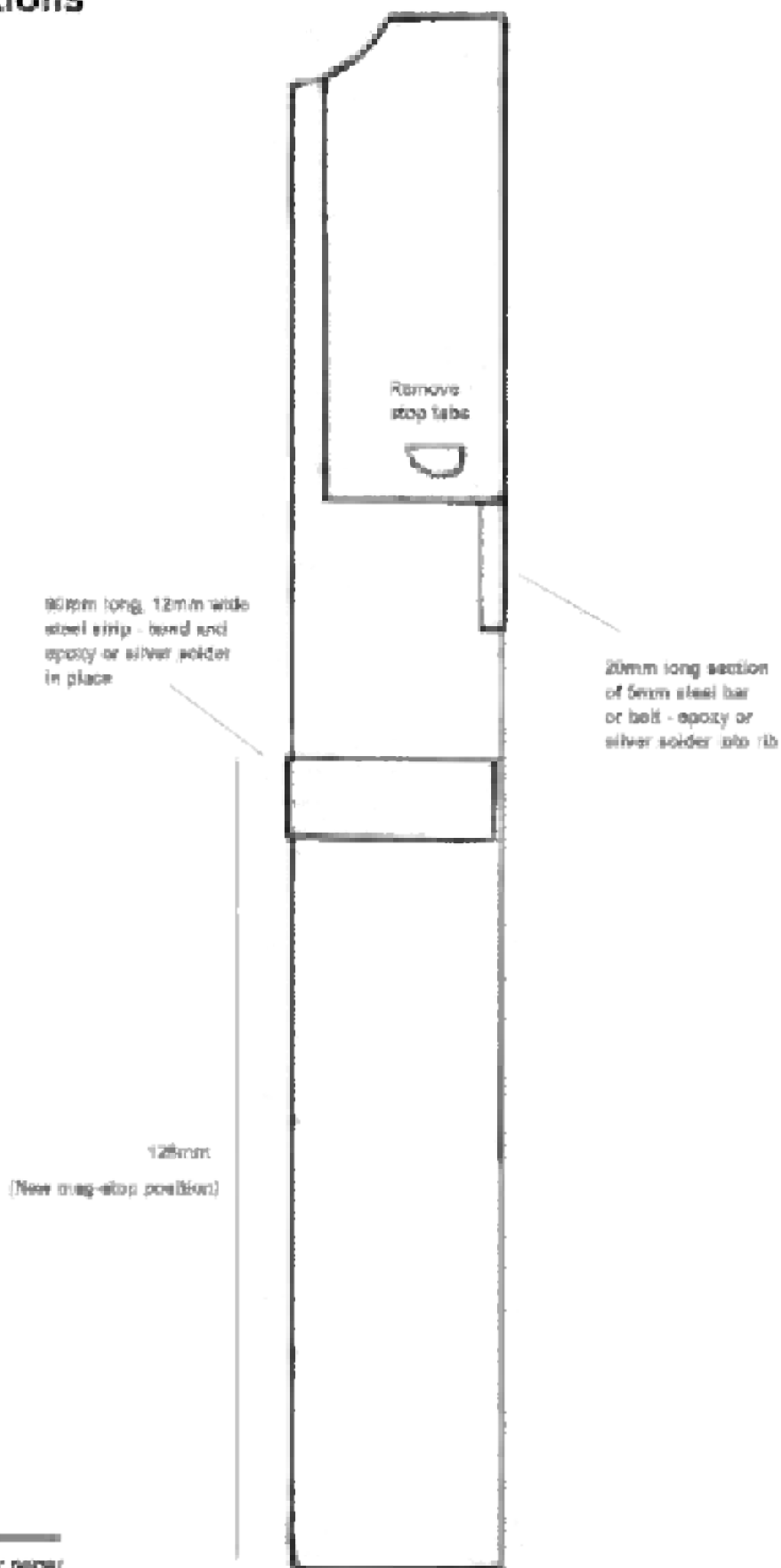

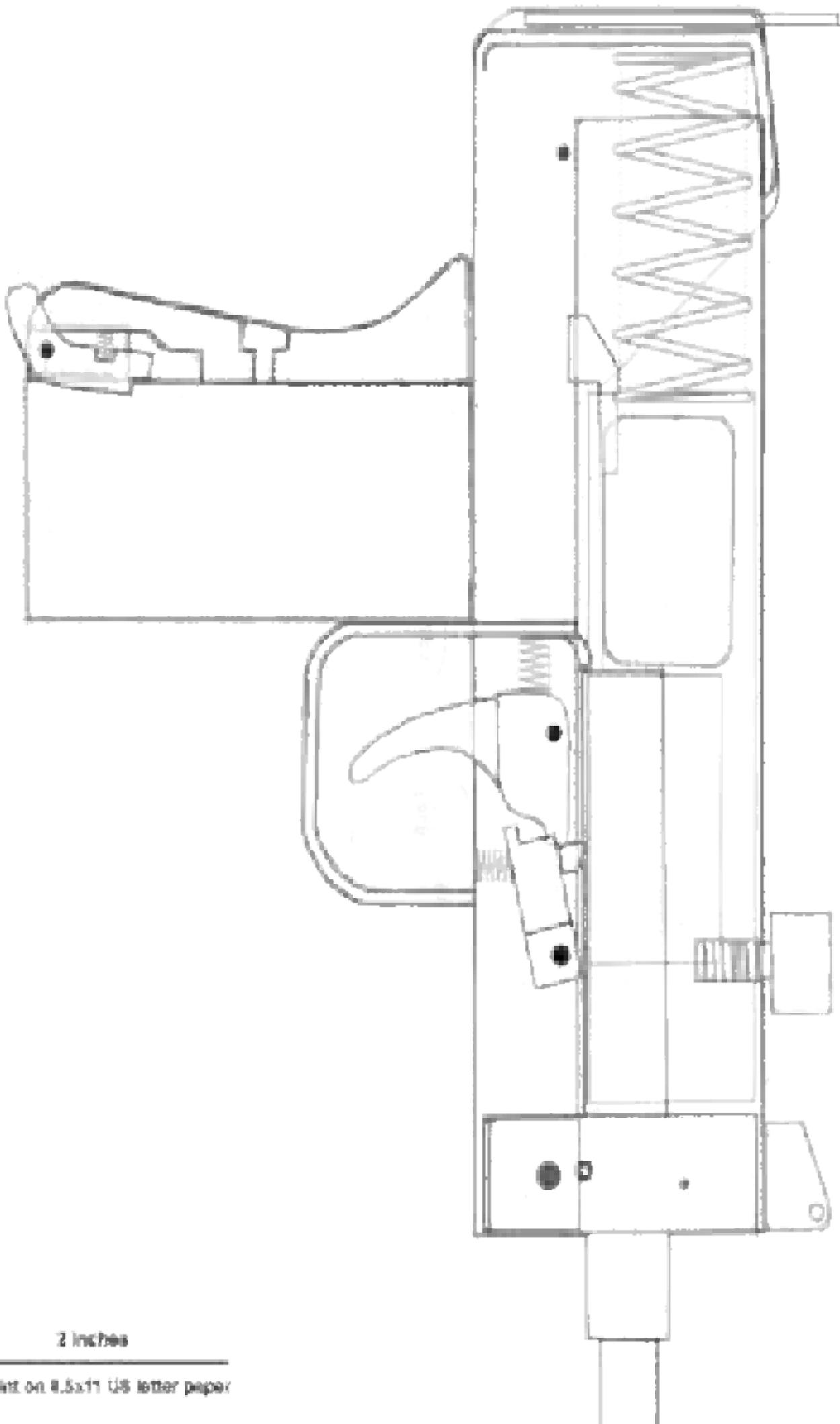

2 inches

Print on 8.5x11 US letter paper

In the following pages a few essential chapters from Home Workshop Prototype Firearms How To Design, Build, And Sell Your Own Small Arms by Bill Holmes (1994, Paladin Press) are reproduced. Following these introductory chapters, practical construction guides for key weapons will be detailed. Make sure to read the build guides after Bill Holmes' chapters, as Bill Holmes' guide is for advanced operations and should be considered in an ideal scenario.

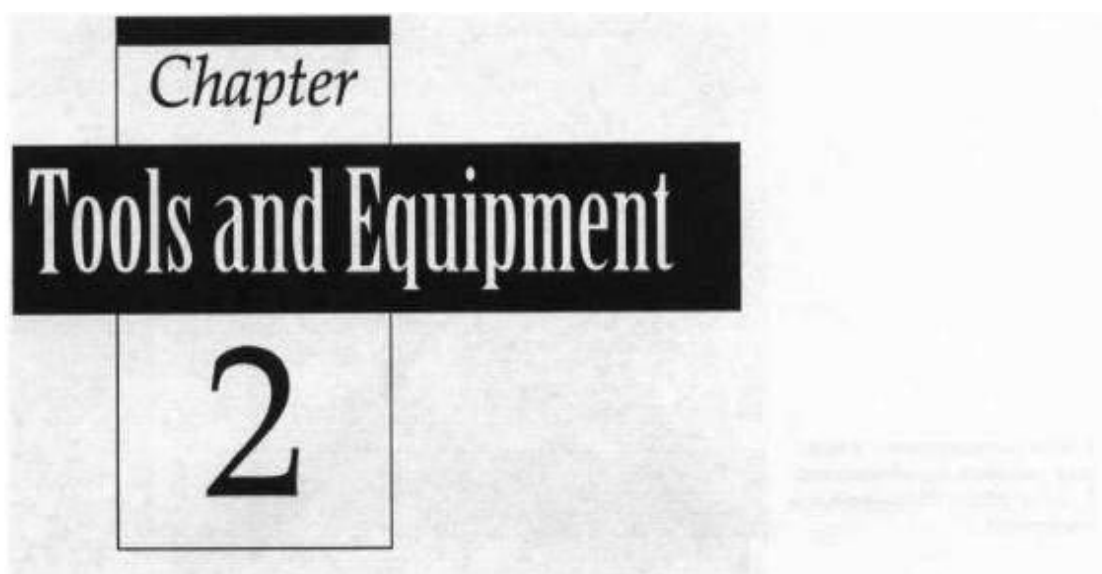

While it is possible (although time consuming) to build a firearm in its entirety with a few files, a hand hacksaw, and a hand drill, decent power tools will not only cut down the construction time but probably also improve the quality of the finished work considerably. Let's take a look at some of the equipment that would be required for an operation of this kind.

Probably the most important item is an engine lathe. With suitable accessories and tooling, such a machine can perform all sorts of operations, including turning, threading, boring, and knurling. With a milling attachment, it can in many instances substitute for a milling machine, take the place of a drill press, and when properly equipped, even put rifling in barrels.

When contemplating the purchase of a lathe for the first time, far too many people actually go out of their way to seek out the smallest machine they can find, not only to save money but with the mistaken idea that the smaller machines are actually more precise when making small parts.

In fact, I read an article sometime back by a self-proclaimed lathe expert in which he stated that a small 6- to 9-inch lathe was best for making most gun parts. He claimed that a larger lathe of 14 to 16 inches would be clumsy to operate, and that the operator would probably break such small parts as firing pins when attempting to turn them on the larger machine.

As far as this writer is concerned, the truth of the matter is that a modern geared head lathe with a 14- or 15-inch swing and 40 inches or more between centers is the only way to go. Such a machine usually weighs a ton or more and, when properly set up on a rigid surface and leveled, will provide a solid, vibration-free platform for turning operations. The geared head machine, in addition to its ease in changing speeds compared to a belt-driven headstock, will also allow heavier cuts to be taken with less tendency to chatter than the belt-drive machine is capable of.

The machine should be level, both lengthwise and crosswise, and preferably bolted to the floor.

A 17-inch lathe, as shown here, is sturdy, accurate, and vibration-free. A 13-inch lathe is adequate and less expensive.

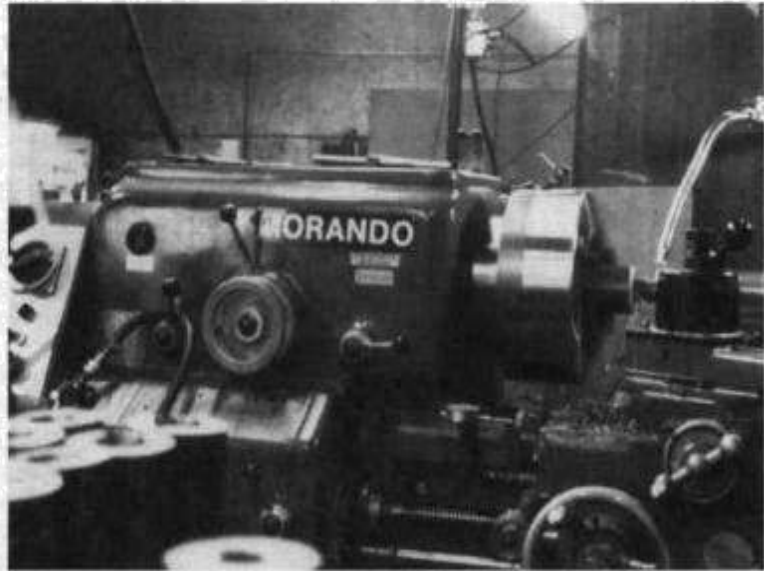

This welding machine will do MIG, TIG, and stick welding.



Many novices neglect to do this, and not only does accuracy suffer, but the machine may wear rapidly due to misalignment.

Most machines of this size will come equipped with three-phase motors. Unless three-phase power is available at your installation, you will require some sort of converter to allow running the motors on single-phase current. These are available through machine tool supply houses, ranging from small boxes for use with one motor to the large Rotophase types, which,

when properly wired into the circuit, will start and run a whole shop full of motors. These are also expensive.

Both a three-jaw and a four-jaw chuck should be acquired with the lathe if possible. If only one chuck can be afforded, it should be the four jaw since irregular shapes as well as round can be centered precisely through individual movement of the four jaws, whereas the three jaws open and close simultaneously and will only accommodate round stock.



A milling machine is almost mandatory if much work is anticipated.

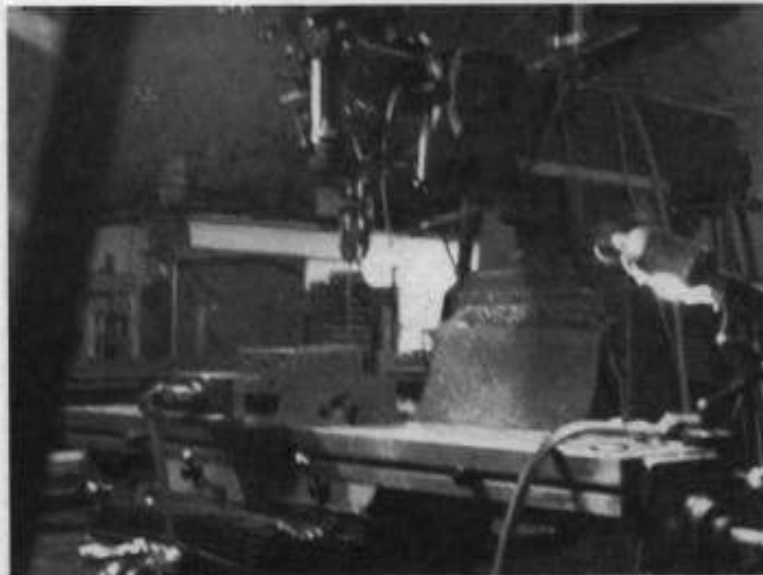

Precise drilling operations can be simplified by using the mill as a drill press.

A set of collets and a collet closer would be nice to have, as well as a quick-change tool post, a live center for the tailstock, a drill chuck, a steady rest, a follower rest, and also, if possible, an adjustable automatic carriage stop.

To better understand why I suggest such extras as an automatic carriage stop, perhaps it would be worthwhile to describe my own shop and its operation.

My shop is a one-man shop. At present I am engaged in building a trap gun of my own

design. By working long hours and running several machines at the same time, I can usually build three of these guns per month. I know, I could hire some help and probably up production. But I have tried it several times in the past, and after a while the employees decided that they knew more than I did and didn't need to do what I told them. I don't like to argue, so I work by myself. If it isn't right, there is only me to blame.

I have two engine lathes: a 15-inch Colchester

A metal-cutting saw is useful.

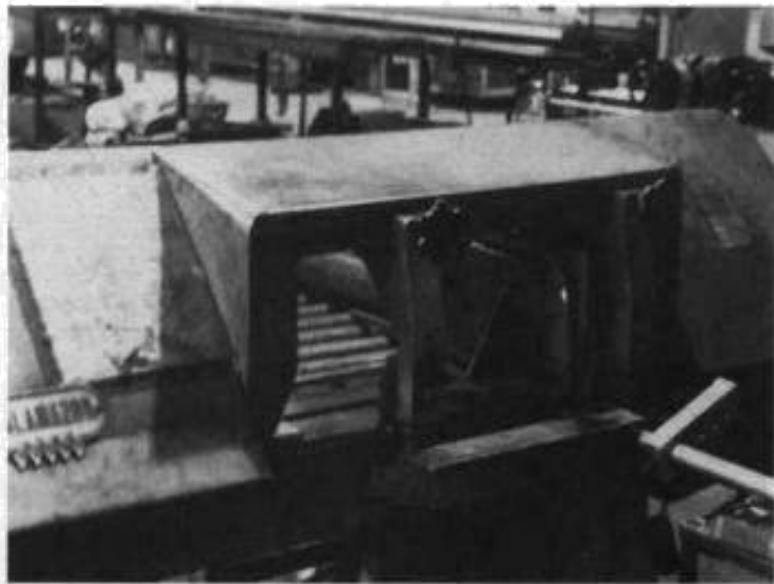

A "cold saw" is faster than a continuous-blade type.

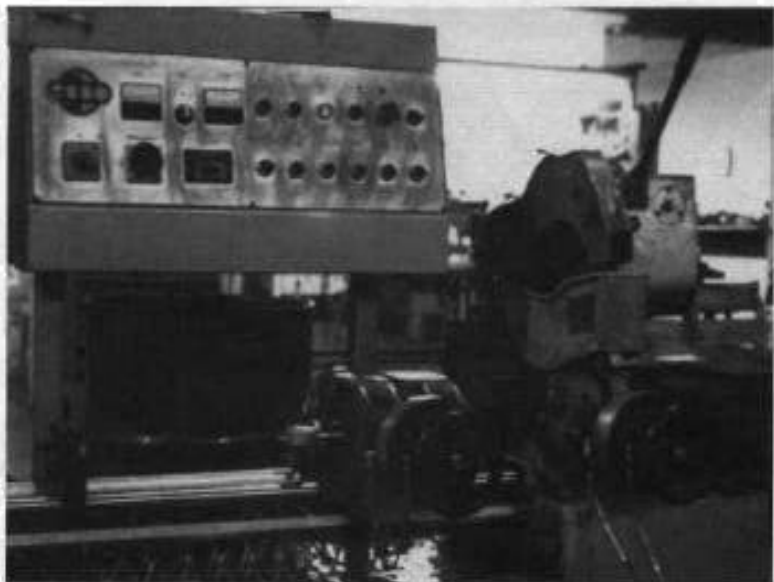

and, parallel to it but facing the opposite direction with a 4-foot walkway in between, a 14-inch Taiwan-made lathe. At one end of the walkway stands an Induma vertical milling machine, while at the other end is a Bridgeport vertical mill. Each has a power feed on the table. Arranged in close proximity as they are, it is possible to run at least two and much of the time all four of these machines at the same time simply by setting up a cut and engaging the power feed of each. Since the automatic carriage stop

will disengage the power feed when it reaches the end of the cut, I can simply go from one machine to the next, setting up a new cut and restarting the power feed.

Located just a short distance away from these four machines, I have a small turret lathe, a combination MIG, TIG, and stick-welding machine, as well as an oxy/acetylene welding and cutting outfit. I have a horizontal metal-cutting band saw with an automatic shut off (which means I don't have to stand over it to shut it off when it



If no milling machine is available, slots and openings can be cut with a hand grinder using cut-off wheels.

finishes a cut), a wood-cutting band saw, and a large vertical metal-cutting band saw. This last machine is even more versatile because it has a built-in blade welder and grinder. This enables me to buy blade material in 100-foot rolls and make up blades for all three saws at a fraction of the cost of ready-made blades.

I also have a surface grinder, a small electric heat-treat furnace, a pedestal grinder, and a couple of bench grinders. Some polishing equipment coupled with a bluing setup and the usual files and hand tools pretty well round out the shop, giving me the capacity to make up about anything I might want in the firearms line. Now if I only had the skills and ability to go with the tools and machines . . .

You probably noticed that I did not mention owning a drill press. This is because I do not have a drill press as such. By mounting a drill chuck in the milling machine, I not only have a solid, sturdy drill press, but I can locate holes exactly where I want them without any guesswork.

The most versatile milling machine for our purpose is a full-size Bridgeport-type machine with at least a 42-inch table. If you anticipate installing ribs on shotgun barrels or machining rifle barrels to a cross section other than round, then a 48- or 49-inch table machine should be procured. Although most gun setups require only a mill vise and no more than four collets—

specifically 1/4, 3/8, 1/2, and 3/4 inches—to take care of 90 percent of any work you may contemplate, it is desirable to have a full set of collets from 1/8 to 3/4 inch by sixteenths. A drill chuck is a required item. Also useful at times are a rotary table, a dividing head, and a boring head. As previously mentioned, a power feed on the machine will allow it to run while you perform other work and is almost like having an extra man in the shop, except you won't have to argue with him.

As with the lathe, the milling machine should be level both lengthwise and crosswise and bolted to the floor. Close attention should be paid to making sure the vise jaws are parallel to the table. Otherwise the machine will not make parallel cuts. I could have bought a little Clausing milling machine at just about my own price not long ago from a fellow who thought it was worn out. I aligned the vise with the table (it was cocked about 2 degrees), leveled the machine, and bolted it down for him. After we ran it for a little while, he took it off the market. He said it was like having a new machine and was no longer for sale.

Many experienced machinists neglect bolting the machines down. Some even snicker when it is suggested. While it is true that the weight of the machine usually will make it fairly solid, bolting it down will dampen and absorb vibration. This, to me at least, makes it worthwhile.

The welding equipment that you should own depends on what types of welding you are proficient at or willing to become proficient at. I say willing to become proficient because to become good at it you must practice, practice, and practice some more. This is the only way to become a first-class welder. You can learn how from books or schools, but experience is the only way to develop proficiency. If you are capable of using them, there are combination machines available that will do TIG (this stands for Tungsten Inert Gas) welding, which is often referred to as heli arc welding, MIG welding (this is a wire-feed process), as well as stick welding, which will take care of about any welding jobs you need to do.

Lacking the skill to use the welding equipment, the best alternative is to find a full-time welder who understands guns and will realize that beads must be built up above the surface to permit machining flush, and what effect polishing and bluing will have on it. The average heavy equipment welder who spends his time

welding on bulldozers, dump trucks, and the like will usually ruin the kind of work you need him to do and should generally be avoided.

In any event, the shop should have an oxy/acetylene outfit to be used for silver soldering, brazing, welding, and cutting, and to apply heat for certain bending and forging operations. It can also be used to harden and temper certain types of steel when no furnace is available.

You will also need a grinder of some sort. A good vise is essential, as is a metal-cutting band saw. Such saws are available for both horizontal and vertical use. Use it horizontally to cut material to length. Vertically it can be used to saw parts such as hammers, triggers, and sears almost to shape, after which they can be finished by milling, grinding, or filing.

Several files of assorted shapes and sizes should be on hand, together with a few metal-cutting chisels, some punches, a scribe or two, and a square and level. Other items can be acquired as needed.



Chapter

Materials

3

Quality firearms should be made of wood and steel. At times it is acceptable to use aluminum as a weight-saving measure. Shotgun muzzle brake bodies are an example of this. But, what I refer to as "pot metal" such as zinc, zamak, pewter, and the like should be avoided.

Quality sporting firearms will have stocks made from high-quality hardwood such as walnut, maple, or myrtle. Beech, gum, sycamore, and the like are used on cheaper guns and are, at most, second best.

There has been a trend over the past several years to try and brainwash the shooting public as to the superiority of synthetic stocks for use on hunting rifles and shotguns. This is mostly a pipe dream that the manufacturers have conned the gun writers into believing and passing on.

While it may be true that in some instances these are more stable and less apt to warp than their wood counterparts (try leaving one out in the hot sun all day), and they are supposedly less prone to cracking and breaking (try drop-

ping one on a hard surface in cold weather), the real advantage is the cost saving due to cheaper materials and less labor.

I have used synthetic stocks and forends myself in the fabrication of military-type weapons and, at one time, in an economy-grade trap gun that I intended to market. This was done, in the case of the military weapons, primarily to save weight, but also because I could obtain surplus M16 stocks at extremely low prices (from \$2 to \$8 dollars each) and easily adapt them to fit my guns. In the case of the trap gun, I molded the grip, used modified M16 buttstocks, and turned the forend from black nylon. The time saved in finishing and elimination of checkering, plus cheaper materials (I used wood costing \$200 in the deluxe-grade gun, as opposed to \$15 worth of materials in the economy grade), was passed on to the customer in the lower-priced gun.

There are all sorts of cheaper grades of steel that could be used to fabricate the metal parts, that is, if we only intended to fire a few rounds

through the gun. But what we are seeking here are materials to make our parts that will last for several thousand rounds and more. Therefore, we must seek out and set in place the best materials available for this purpose. While there are people who would question my choices, as far as I am concerned, chrome molybdenum steels such as 4130, 4140, and 4150 are suitable to build the entire gun. Known as Chrome moly, Brake die, Maxell and other nicknames, these steels are easily heat treated, machine cleanly, and possess high tensile strength and elasticity. Furthermore they can be welded without ruining them, as sometimes occurs with other steels.

Nickel steels of the 2330-2340 variety are also entirely usable, as are the nickel chromium steels designated 3130, 3135, or 3140.

The numbers associated with these steels, in case anyone is wondering, are partial descriptions of their compositions. The first figure describes the class to which the steel belongs. The second figure indicates the percentage of the main alloying element. The last two figures indicate the carbon content in hundredths of one percent or "points." Therefore, 3140, as an example, describes a nickel steel with approximately 1 percent nickel content and a carbon content of forty hundredths of one percent, sometimes referred to as 40 points of carbon.

4130 seamless tubing is ideal for shotgun barrels, tubular receivers, and the like. It is usually available from metal supply houses in so many inside diameters and wall thicknesses that at least one will be close enough to adapt to your use.

Round stock is available in the desired compositions and in almost any diameter needed from these same metal supply houses. Flat stock for hammers, sears, triggers, etc., is also available from the same sources in almost any fractional thickness desired.

In many cases, these materials must be purchased in rather large quantities. If the vendor can be persuaded to cut off the small quantity desired, they will charge you an exorbitant price for it. Many metal supply companies will try to charge \$15 to \$25 just to saw a piece of metal in two.

Therefore, when only one gun is to be built, look for some other source of materials. Automobile and truck axles contain material suitable for bolts, barrel extensions, gas cylinders, and whatever other round parts are need-

ed. Actually, if sawed into strips, flat parts can also be made. Axles can usually be obtained from salvage yards for \$2 to \$5 dollars each. Leaf springs, as used on the rear axles of older cars and pickup trucks as well as on larger trucks, are a source of flat stock. Hydraulic cylinders and discarded shock absorbers contain smaller-diameter shafts useful as round stock and tubing. This tubing will seldom, if ever, be adaptable to shotgun barrel use, but in certain instances it can be used for receivers. Motorcycle front forks will yield just about the same sizes and types of tubing and round stock as the hydraulic cylinders, as will large-diameter aluminum tubing, which can sometimes be used to make shotgun muzzle brake bodies.

Some of the material suggested, especially the axles and leaf springs, will be too hard to machine easily. They will require softening, or annealing. This is accomplished by heating the metal slightly above its critical point and allowing it to cool slowly. Since the average heat-treat furnace is too small to fit the axles or spring leaves, another method must be found.

Fire departments usually take a dim view of uncontained open fires within city limits, so you will likely have to go to the country to do this. Accumulate and pile up enough wood to make a fire that will completely surround the metal objects and burn for three or four hours. Place the metal objects on top of your wood pile and start it on fire. If you have enough wood, it will heat the metal to the required temperature. As the fire burns down, the metal parts will sink into the ashes, where they cool very slowly. They are usually left overnight; when removed the next morning, they will probably still be warm. They will also be softened to a point where they will machine easily.

The axles described are usually made from material with a high enough carbon content to permit heat treatment to any hardness desired. Many of these are made from the same 4140 recommended in the first place. They are also found made from 4150, 4340, 2340, 3140, and other alloys.

Leaf springs are mostly made from material with a high carbon content. Compositions commonly found in these are 1085, 1095, 4063, and 4067.

It should also be mentioned that the stems of

automobile engine valves are suitable for firing pins. They, too, must be annealed before they will machine freely.

After the component parts are cut to shape, fitted, and finished, they should be heat treated as detailed in Chapter 20. Properly done, parts made and heat treated as described will last a lifetime.

For those who think a gun should be made from stainless steel (I am not one of these), it should be noted here that seamless tubing of the same dimensions deemed proper for the shotgun barrels described is available with a cold-drawn finish in 416 stainless according to the company I buy from. Round and flat stock is available from the same source. If you must have stainless, an alloy called 416F, which is a nickel-bearing chromium steel with enough sulphur added to make it machine freely, is probably the best choice available.

There are any number of companies and individuals advertising gunstock wood in several of the gun magazines. If you will be satisfied with black walnut, a local lumber yard usually will have at least a small supply on hand. This is true in the eastern and midwestern states. In California and other far western states, one can also find a goodly supply of so called "English" and "Claro" walnut. It is advantageous to be able to examine wood before you buy it.

Most large cities have at least one plastic supply house that carries, or can get, black nylon or other synthetic material to use in forends. Fiberglass and epoxy can be found at auto parts houses. They sell it to body shops for use in auto body repair. Boat builders and repair shops also keep a supply on hand. If M16 buttstocks are required, several surplus gun parts suppliers advertise them for sale.



Chapter

Helpful Hints

6

The purpose of this chapter is to pass on any bit of information that I can think of which might be helpful to you. Some of it might have been included in other chapters. Other parts of it probably have no relevance whatsoever. But again, some of it might come in handy.

When drilling holes, if they are expected to be round and straight, sharp drills must be used. The material to be drilled should be clamped or held in a vise and secured to the mill or drill table. If you try to hold it in one hand and feed the drill into it with the other, as many people try to do, torque caused by resistance to the drill tries to turn the material in the opposite direction, causing the drill to crawl off center. This is the cause of most crooked or oversize holes.

Holes should be started, especially on rounded surfaces, with a center drill, drilled to depth with an undersize drill, and finished with a drill of the proper size. When holes are to be tapped partway through, the hole is first drilled with the tap drill, the full-size portion drilled for

clearance, and the hole tapped, in that order. When drilling for pivot pins, such as for a trigger or hammer, the frame or housing that the pivoting part fits into should be drilled from the side that the pin is installed from with a drill of the same size as the pin. The opposite side is drilled with a slightly smaller drill to grip the pin and hold it in place, and the hole through the pivoting part slightly larger so that it will pivot without binding.

Contrary to popular opinion, a .125-inch pin will not rotate freely in a .125-inch hole. Assuming that we are using a 1/8-inch pivot pin, we drill the hole completely through all surfaces with a No. 31 drill, which measures .120 inch, or .005 undersize. The one side is drilled to 1/8 inch, or .125 inch. The hole through the pivoting part is drilled with a 3.20 millimeter drill, which has a diameter of .126 inch. This will allow the part to pivot on the pin without resistance and still not wobble. Holes for other sized pins are done in the same manner.

Straight holes can be drilled fairly close to

their required location with a hand drill, provided that the work is clamped or otherwise secured to prevent its movement. Both hands should be used to hold the drill in an absolutely vertical position, or at 90 degrees to the work. Holes should be started with a center drill and drilled to depth with an undersize drill, followed by the drill of the correct size.

If absolute precision of hole location is essential, the milling machine should be used in the same manner as a drill press, with the work fastened securely to the table and moved into exact location with the table feeds. Even now, the center drill should be used first, followed by drills as described above.

Bolt lugs, raceways, holes spaced around the diameter, etc. are located and spaced through use of a rotary table, dividing head, or spacer. In the event none of these are available when needed, fair success can be had in locating equally spaced positions around the outside diameter by wrapping a strip of masking tape around the work and marking the exact length of one turn. The tape is removed, laid out flat, and measured. This measurement is divided by the number of positions required and each of these marked on the tape. The tape is then wrapped around the circumference of the work once more. Each of these marks now represents a center line for the rows of holes used in the shotgun muzzle brakes, or center lines for bolt lugs, or whatever. Inside divisions can be made by wrapping the tape around a shaft that fits the inside diameter closely and dividing as above. It is then inserted into the work and location marks transferred from the tape to the end of the work. This method is not intended to replace precision equipment, but if only a few such operations are to be undertaken and the equipment is not available, this method will pinpoint locations to within a very few thousandths, if care is taken.

Grinding wheels are usually too slow to shape metal parts. The sanding discs used primarily in automobile body shops are available from hardware and auto parts stores. These are fairly stiff, fiber-backed discs usually of 7- or 9-inch diameter. They are available in grits ranging from 24 to 120. A backplate just slightly smaller than the discs is made from plastic, masonite, etc. and mounted behind the disc on

an arbor. Parts can be shaped to almost exact contours using this method. These are also useful when shaping wood.

Inside polishing, such as inside trigger guards and the like, is made easier by sawing a lengthwise slot in a wood dowel. Strips of abrasive cloth or paper are mounted by placing one end in the slot and winding several turns around it in the opposite direction of its rotation. A 1/2-inch drill chuck that can be mounted on a motor arbor and the dowel chucked in it is ideal for this. Use a fairly high-speed motor of 3750 RPM or similar for this.

Recoil pads mounted on the straight-line recoil type buttstocks have upper mounting screws that come out right in the place where the stock bolt hole is located. Sometimes another screw can be located higher and miss the bolt hole. It is easier to silver-solder a screw head to the end of the stock bolt that will accept an Allen wrench. The recoil pad's upper screw hole is enlarged to permit insertion of the Allen wrench and a corresponding slot cut in the face of the pad. The pad is then mounted in place using epoxy cement and the lower screw. The stock bolt is turned by inserting a long, round-bodied Allen wrench through the face of the recoil pad. If a coating of oil or grease is used to lubricate the Allen wrench, the face of the recoil pad will show little or no evidence of the wrench insertion after it is withdrawn.

Marks and scribed lines on metal are often hard to see during the sawing or milling process. A thin coat of layout fluid such as Dykem brushed on and allowed to dry for a few minutes will make subsequent lines more visible. This product is available from both machine tool and gunsmith supply houses in red, blue, or other colors. Obtain a can of remover and thinner at the same time. An even better method consists of polishing the surface of the metal bright and swabbing on a solution of copper sulfate. This will leave a thin layer of copper deposited on the surface that causes any markings to stand out vividly. Copper sulfate is a blue crystalline powder available from drug stores. It is also known as Bluestone and Blue Vitroil. The solution is made by adding all the copper sulfate that four ounces of distilled water will dissolve. Add 12 to 15 drops of sulphuric acid to this.

Years ago, a cold bluing solution that came in two bottles was marketed. The contents of the first bottle (copper sulfate) was swabbed on the clean bright steel, which imparted a thin copper layer. The contents of the second bottle, which consisted mostly of arsenic trioxide, was applied next, which turned the copper black. As I remember, it resulted in a better black color than the modern cold blues. But, like most of the others, it started to rub off in a short time. It was also one of the foulest smelling concoctions I ever came in contact with.

In many instances, silver solder will be used to mount sight bases, trigger guards, barrel bands, and various other parts. There are people who will tell you that the correct way to join parts using this material is to cut strips of the flat "ribbon" material and sandwich it between the parts to be joined, whereupon heat is applied, the solder melts, and, when cool, the joint is made. This may work for some people. Everytime I tried it, however, the results were somewhat different. When the work is clamped together and the sandwiched silver solder melted, the parts tend to shift or slip in their relationship to each other. Besides that, I was never sure that all the solder melted and flowed.

A far better method, at least for me, is to apply flux to the surfaces to be joined and clamp them together. The adjacent surfaces are rubbed down with soapstone or a soldering "talc" crayon, which will prevent the solder from adhering to the exposed surfaces. Using a wire-type silver solder of 45- to 55-percent silver content, the joint and surrounding metal is heated until it just begins to turn red and the end of the solder touched to the joint. The application of heat is continued until the molten solder is visible all around the edges, at which time the heat is withdrawn and the work allowed to cool. Care must be taken not to overheat it since silver solder has a tendency to simply evaporate when overheated, and the fumes are toxic. The joint is then cleaned of the flux and soapstone residue, and any excess material is removed using files or scrapers.

Whether we like it or not, sooner or later we will be required to turn the outside of a barrel to a specific size and contour. The easiest way, as concerns the small shop, is to mount the barrel between centers in the lathe and set the tail stock

over enough to cut the appropriate taper. Since the breech end usually has a threaded shank followed by a straight tapered forward section followed by an abrupt taper or tapered curve, there is usually a length of 18 to 20 inches that consists of a straight, gradual taper usually of .150 to .200 inch over the entire length. This taper can be set up to give an almost exact measurement by mounting a dial indicator on the cross slide of the lathe and measuring the amount that the tail stock is set over. After a few passes are made with the lathe tool, and while the barrel is still oversize, the muzzle end and the point where the taper ends are measured. The amount of tail-stock set-over is changed to correct whatever error is present.

A steady rest can be used to support the barrel and dampen it to prevent chatter by offsetting the steady rest jaws to coincide with the tail stock offset, but it will require moving a couple of times. Usually there will be a slight step or ridge where the previous cut is stopped and a new one started. Therefore it is probably easier to turn the full length without using the steady rest, instead using a wood block held against the barrel to dampen the vibration and draw filing the entire length to remove tool and chatter marks, finishing with varying grits of bench strip.

When using high sights, it is extremely important that the sights stand exactly vertical, or straight up and down. This can present a problem, since these are not easy to hold in place with clamps or to determine when they are straight up. One way to do this is to clamp the receiver or barrel in the milling machine vise, making sure it is square and level. A rod with a sharp conical point is mounted in the mill collet. The sight assembly is located in place and held by pressure between the quill and mill table. A weighted string, or plumb line, is suspended from the ceiling directly in front of the work. Then, by sighting along the surface, the sight assembly can be aligned vertically with the string by moving the cross feed of the mill table until it is straight up and down, whereupon the sight assembly is silver-soldered in place.

Turning long firing pins can present a problem. The lathe tool must be sharp and set up to contact the material to be turned exactly on center. The material is mounted in the lathe with one end extending from the chuck for a short

distance and the free end supported by a center. This section is turned to size, taking light shallow cuts. It is then extended further and again turned to size. This is repeated until the entire length is formed. It is then mounted in the lathe chuck with just enough extending to turn the nose to its specified diameter, and the counter-stink end for the lathe center is removed. The hemispherical tip can be formed with a file and polished with abrasive cloth.

Coil springs must be supported for most of their length, either by an inside guide pin or a spring pocket enclosing most of the spring's length. Otherwise they may buckle and deform, rendering them inoperative. As used with triggers, sears, extractors, etc., spring pockets are drilled in the part to contain most of the length of the spring, thus supporting it around the outer surface. When coil springs are used as long, traveling hammer springs and the like, they must be supported by an internal guide rod. Many times, the compressed length should be taken into consideration when determining spring pocket depth and length of travel of moving parts. This is easily determined by multiplying the number of coils in the spring by the diameter of the wire that the spring is wound from.

There are times when it is important to determine thread depth, and no chart or table is on hand to refer to. The root diameter (the size of the screw shank remaining inside the threads) can be determined to within a couple of thousandths by dividing the pitch, or number of threads per inch, into 1.299. Since a 100-percent thread will not screw into a 100-percent hole, some clearance must be allowed. A 75-percent thread is an accepted standard. Therefore we would take the result of the division above and use 75 percent of it, which gives a satisfactory tap drill size or hole size in which threads will be machined.

When glass bedding or epoxy-based compounds are used to reinforce or fill gaps between wood and metal joints, it is absolutely necessary that any holes, depressions, cracks, seams, or anything else that this material may be forced into when drawn together be plugged or sealed to prevent such from occurring. Holes can be plugged with paraffin wax, cracks and seams taped over, and slots and depressions filled with wax. All surfaces except the ones the substance

is to adhere to must be coated with some sort of release agent to prevent them from becoming bonded together permanently. If no commercial release agent is available, automotive paste wax can be used. Give the exposed surfaces a thin coat and let it dry, then give them another coat. All screw threads must also be coated. Antifreeze that contains glycerine can also be used for this.

Shotgun bores and chambers, as well as rifle and pistol chambers, can be polished by slotting the end of a wood dowel, inserting one end of a strip of abrasive cloth or paper in the slot, and winding it around the dowel in the direction the work rotates. With the barrel held in the lathe chuck, the cutting end of the dowel is inserted in the bore, the lathe turned on, and the hand-held dowel moved slowly back and forth through the bore. The abrasive material should be a snug fit in the bore and will require frequent replacement. A final polish should be applied using 400 grit (wet or dry) paper followed by crocus cloth. Lubricant is used throughout the process. Chambers can be polished in the same manner by using correspondingly sized dowels. This is, more or less, a makeshift operation to be used in the absence of commercial hones and polishing heads. However if sufficient time and effort is invested, it will give good results.

When barrels are installed, either in receivers or mated to barrel extensions, they must be drawn up tight. When mated to a receiver, this is easily accomplished using a barrel vise and an action wrench. The barrel extension sometimes presents problems since it is difficult to fasten onto with a means to turn it. One way to tighten or remove it is to bore a pair of hardwood blocks to the same diameter as the extension. A clamp is made with a bolt on each side to fit over and contain the blocks. One leg of this clamp is either long enough to serve as a handle or turned to fit inside a length of pipe, which serves as a handle. This is used in the same manner as an action wrench.

Flat parts can be polished while retaining flat sides and sharp edges by placing abrasive cloth or paper on a sheet of plate glass and rubbing the part to be polished back and forth across it. As usual, progressively finer abrasive grits are used, as well as cutting oil.

Holes can be drilled or bored in the lathe and

shoulders and threads can be cut to exact depth by mounting a dial indicator on the lathe bed in a location where the stylus will contact the lathe carriage as it reaches the bottom of the cut. The indicator should be set up to stop on a number after the indicating hand has traversed the dial a couple of times, not just as contact is made. This will give ample warning before the stopping point is reached.

There are times when slots must be cut that cannot be reached with ordinary milling cutters. It is also difficult to cut such slots with a hacksaw, since succeeding saw cuts tend to slip over into the adjacent cut. If the mounting pins in the hacksaw are replaced with longer pins, more than one blade can be mounted simultaneously in the saw frame. This will allow wider slots to be cut at one time, with the slot width regulated by the number of blades used.

Most feeding problems in box-magazine guns can be alleviated by reshaping the magazine lips and/or follower. If the nose of the cartridge or shell tries to contact the top of the chamber before entering, the magazine lips should be bent inward slightly. Reshaping the

follower so that the forward end rides lower in the magazine may also correct this. If the shell hits at the bottom, the magazine lips are spread slightly or the follower is bent to ride lower at the rear. Sometimes the cartridge nose will hang on the left or right sides. This can usually be corrected by bending the lip slightly upward on the side the bullet should be steered toward, or by bending the opposite side downward.

When small boring bars are needed for use in the lathe and none are available, end mills can be mounted in the tool post (especially a four-way tool post) and one flute used as a cutting edge. The body should be angled just enough to provide clearance. You can't bore deep cavities with these, but they work in a pinch.

To obtain a good finish when turning plastic, as with forends, a sharp, round-nosed tool should be used. It should have twice as much clearance as used for cutting steel and no rake. The material is turned at a fairly high speed and fed slowly. This material must not be allowed to overheat since the surface tends to melt, spoiling the finished surface. Therefore, friction, the primary cause of heating, must be kept to a minimum.



Chapter

Building a Gun

16

Using what we have discussed and learned in the previous chapters, it is time to put it into practice and actually build a gun. The example used herein is a 12-gauge slide-action military and police gun with a 10-shot detachable box magazine. Other types and calibers can be fabricated using similar methods.

As recommended earlier, we will build the magazine first. Since it is not practical to form the compound curves required in the small shop, we will have to weld up the magazine body using four sheet metal components. Cut the two sides to shape, making sure they are identical, and the two end plates. These are bent to match the curves in the side panels. With the four parts clamped in their respective positions, the four seams must be welded for their entire length and then ground flat and smooth. This is a hard way to get a magazine, but at least it is a way. The bottom plate is cut to shape from the same 20-gauge sheet metal and the sides folded to correspond with the flanges bent outward at

the lower end of the magazine body. The follower is bent to shape as shown. Likewise the bottom cap retainer. The magazine feed lips are bent inward and welded to the backplate. A small block is silver-soldered in place on the backplate for the magazine latch to engage and hold the magazine in place in the gun. The spring should be wound or bent to shape from .065-inch spring wire, commonly known as piano wire or music wire.

The upper receiver is cut to length from 1 1/2 inch outside diameter 4130 seamless tubing with a .120 inch wall thickness. The front end is threaded to accommodate the barrel retainer nut and the various openings cut to the dimensions given. The blocks for the front and rear mounting bolts are welded in place on the lower side. A guide must be fastened inside the receiver to hold the bolt head in its open position during its fore and aft travel. Three 1/8-inch slots are milled in the upper receiver as shown and matching tabs milled on the guide. These are mated together and welded in place.

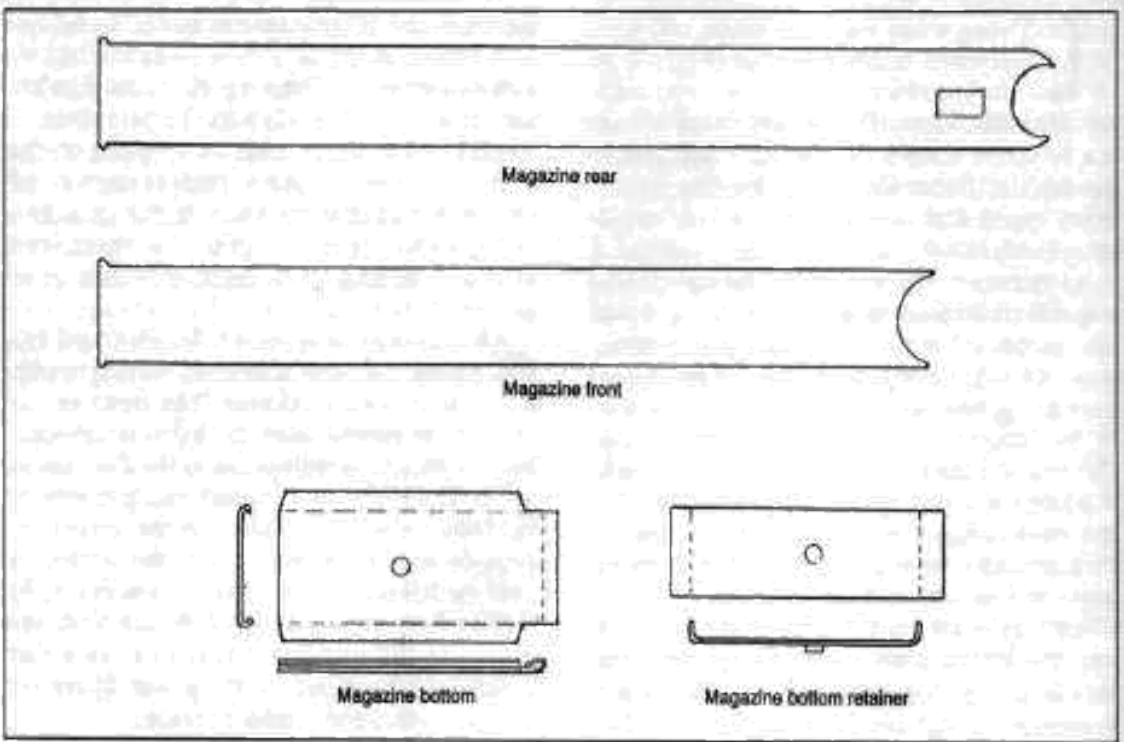
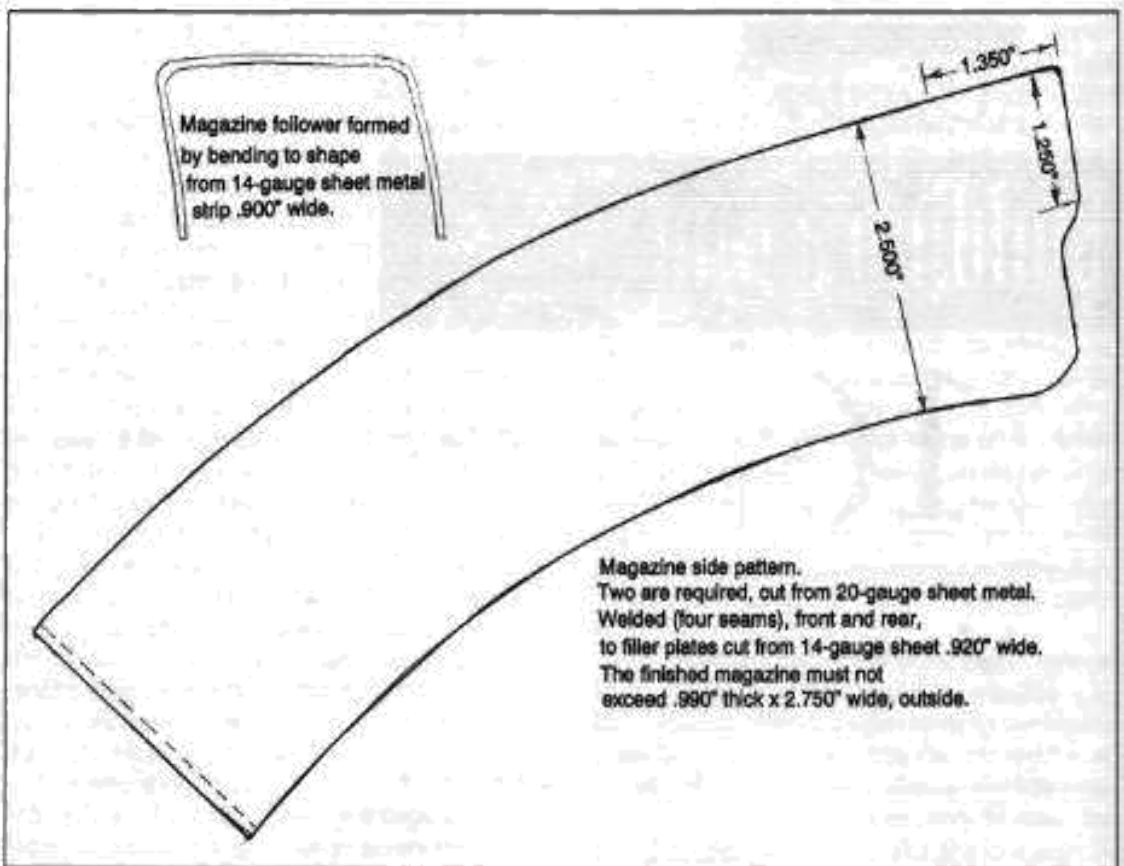

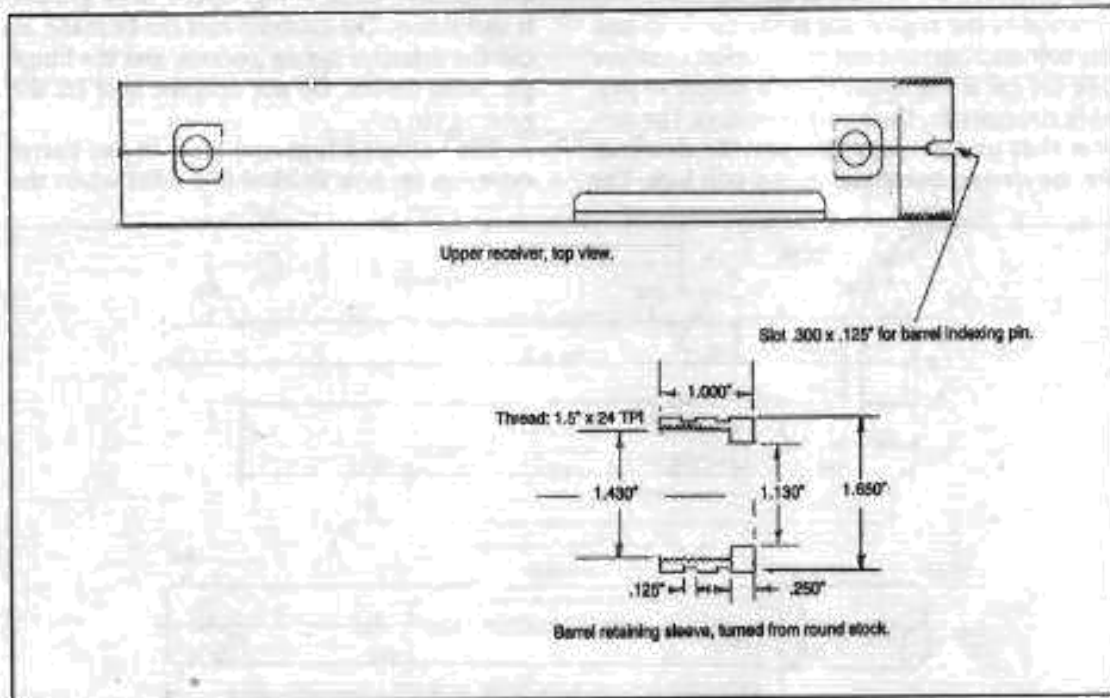
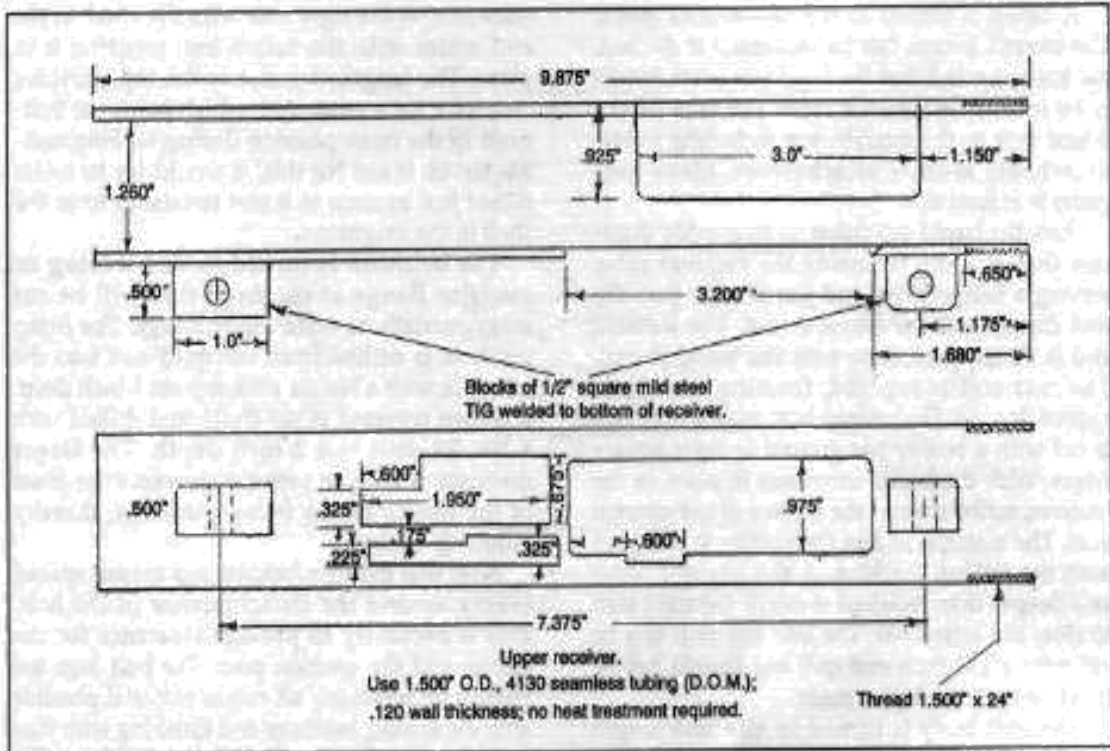

A barrel is turned to the dimensions given. The overall length can be increased if desired, but keep in mind that the legal minimum length is 18 inches, measured from the face of the closed bolt to the muzzle, not including screw-detachable muzzle attachments. Make sure yours is at least that.

Turn the barrel extension to an outside diameter that is a slip fit inside the receiver tube, leaving a flange at the end just smaller than the root diameter of the barrel thread. The forward end is threaded to mate with the barrel thread. The rear end is tapered, forming a shallow approach cone. The counterbore for the bolt lugs is cut with a boring bar ground to form square edges. With the barrel extension in place in the receiver, scribe around the outline of the ejection port. The material within the outline is removed with the milling machine. A slot slightly wider and deeper than required is cut in the right side to clear the action bar. The bolt lug slots can be cut with a 1/2-inch end mill but should not be finished until the bolt is made.

The bolt body is turned to size and length and bored for the firing pin and bolthead. The function of the angled slot at the top is to cam the bolthead into and out of its locked position. The flat cut at the upper front is simply to provide clearance for the barrel extension. The narrow slots on the lower side provide clearance for the ejector, disconnector, and bolt lock. The

wide slot on the right side with the notch at the end mates with the action bar, securing it in place. The lengthwise slot at the top provides clearance for a guide rail, which holds the bolt-head in the open position during its longitudinal travel. If not for this, it would try to rotate closed just as soon as it met resistance from the shell in the magazine.

The bolthead is turned to size leaving an oversize flange at the front that will be cut away partially to form the bolt lugs. The firing pin hole is drilled from the front end into the bolt face with a No. 31 drill at least 1 inch deep. It is then reversed in the chuck and drilled with a No. 29 drill to a 2 inch depth. The larger diameter is only to provide clearance for most of the length of the firing pin body, thereby reducing friction.

Note that the four locking lugs are not spaced evenly around the circumference of the bolt. This is necessary to provide clearance for the ejector and the ejection port. The bolt lugs are formed by removing all excess material possible with the milling machine and finishing with files and abrasive cloth. A high-speed hand grinder is useful here. The extractor cuts can be made, as can the extractor spring pockets, and the hinge pin holes drilled. Do not drill the hole for the rotating pin yet.

The bolthead lugs and slots in the barrel extension are now finished to a point where the

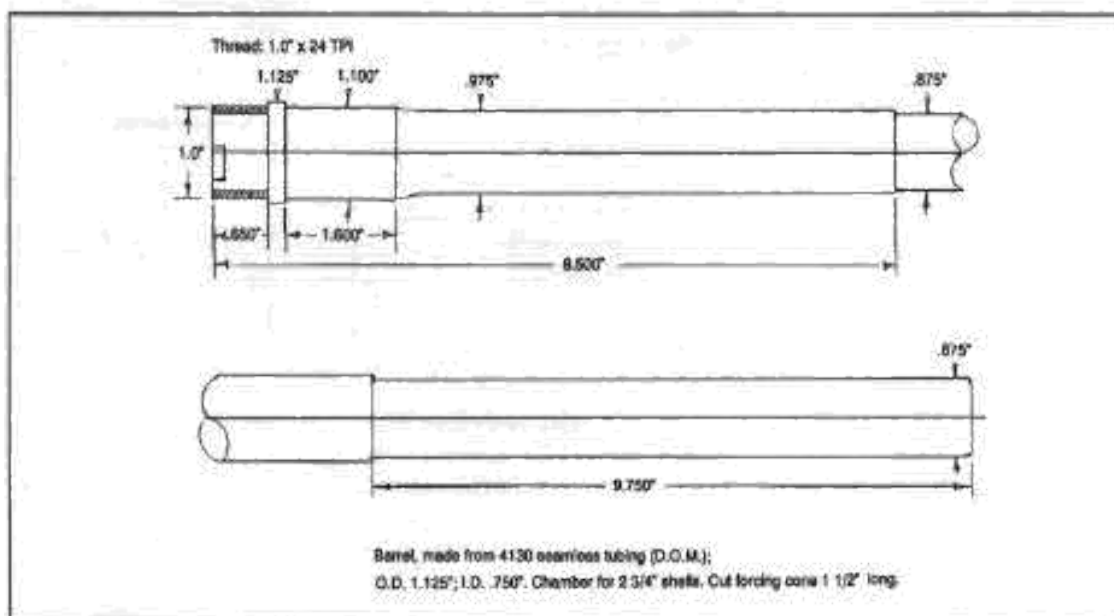

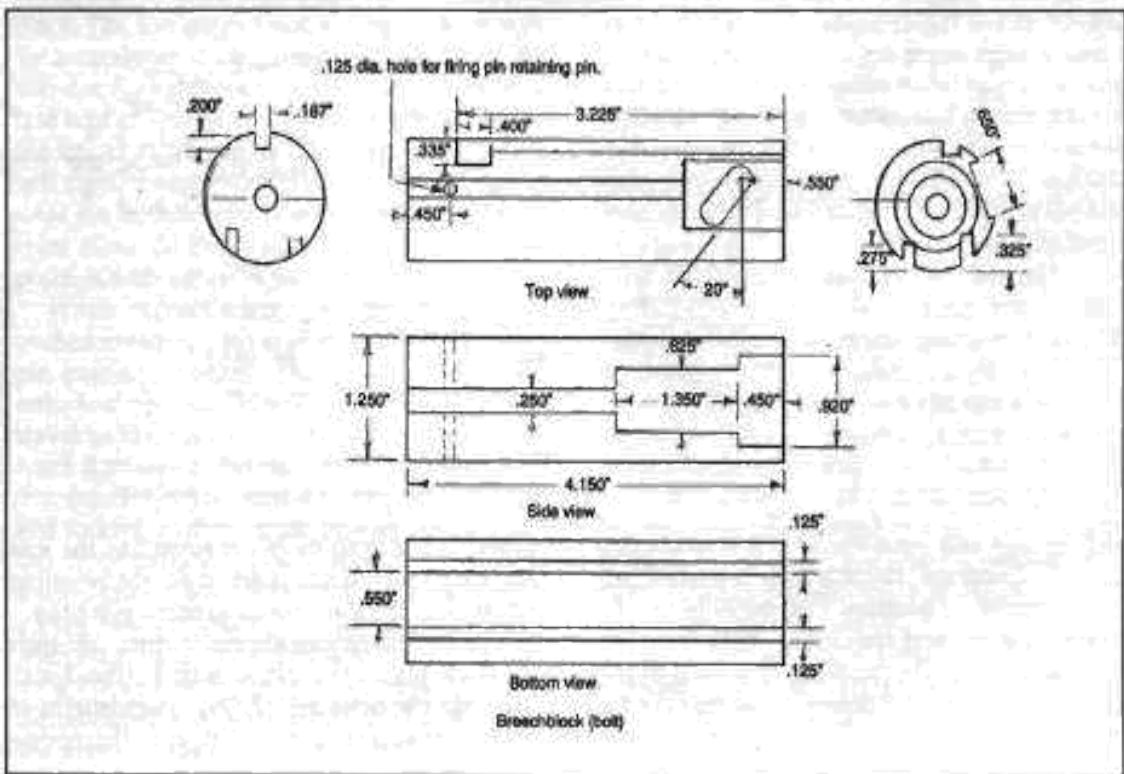
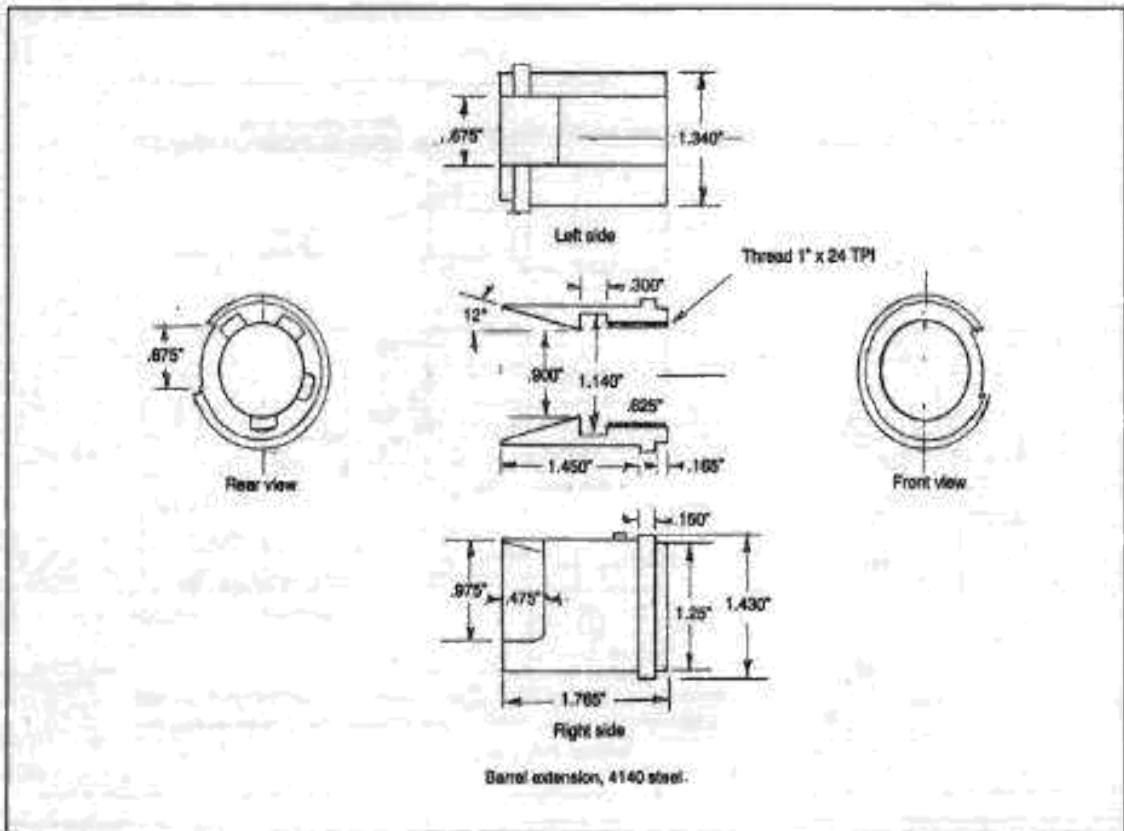

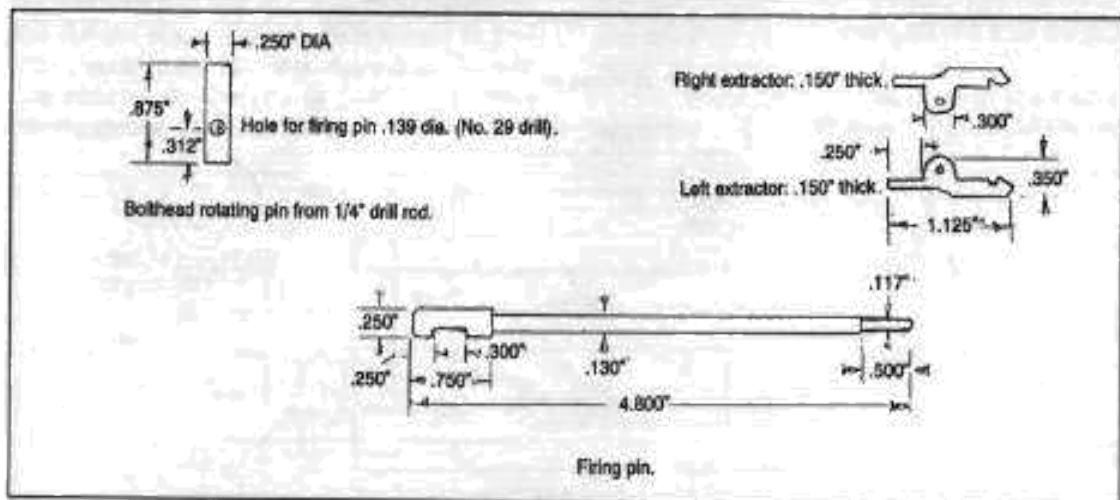
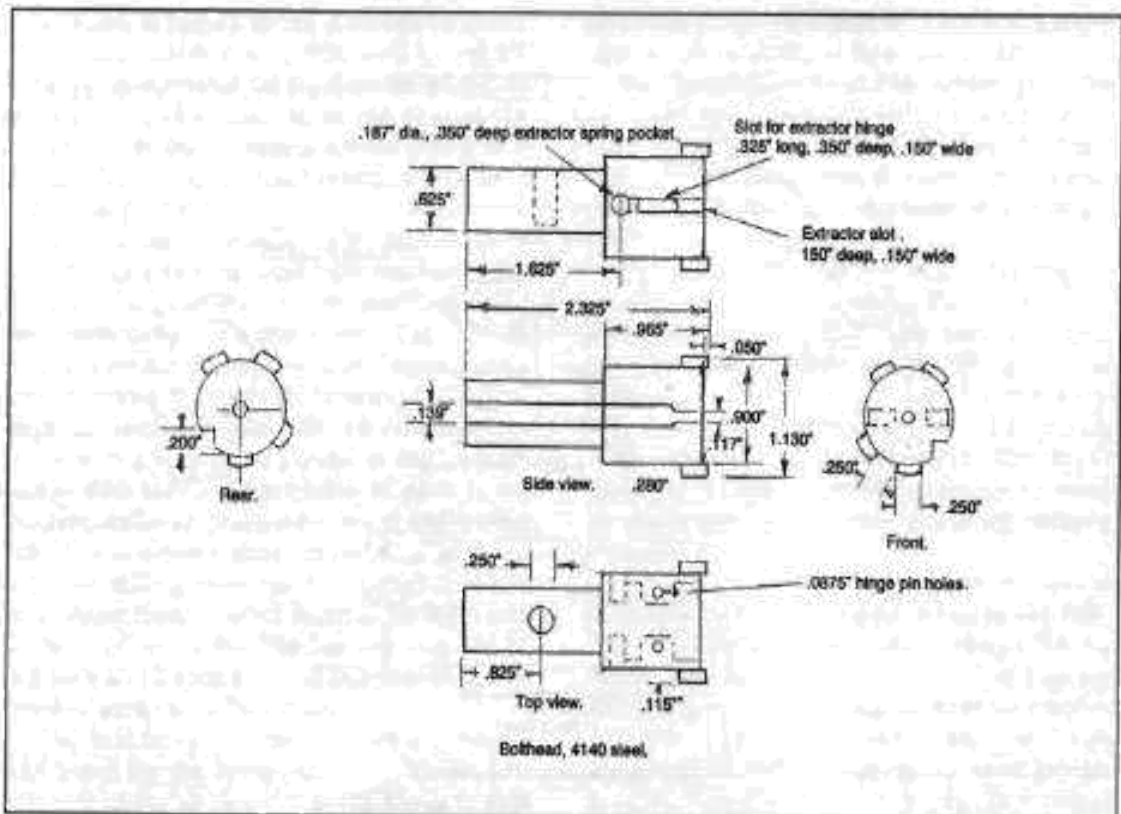

locking lugs will enter the slots and rotate into the locked position. The bolt body is pushed into its forwardmost position and the hole for the rotating pin marked and drilled. With the rotating pin in place, the No. 29 drill is used in the firing pin hole to drill through it so that the firing pin fits through the rotating pin when

assembled. The firing pin is turned to the size and shape shown and notched for the retaining pin, which fits crosswise through the bolt body.

The two extractors are made from .156-inch flat stock, placed in position in the bolthead, and the hinge pin holes drilled. Two short lengths of small coil spring that will fit into the spring

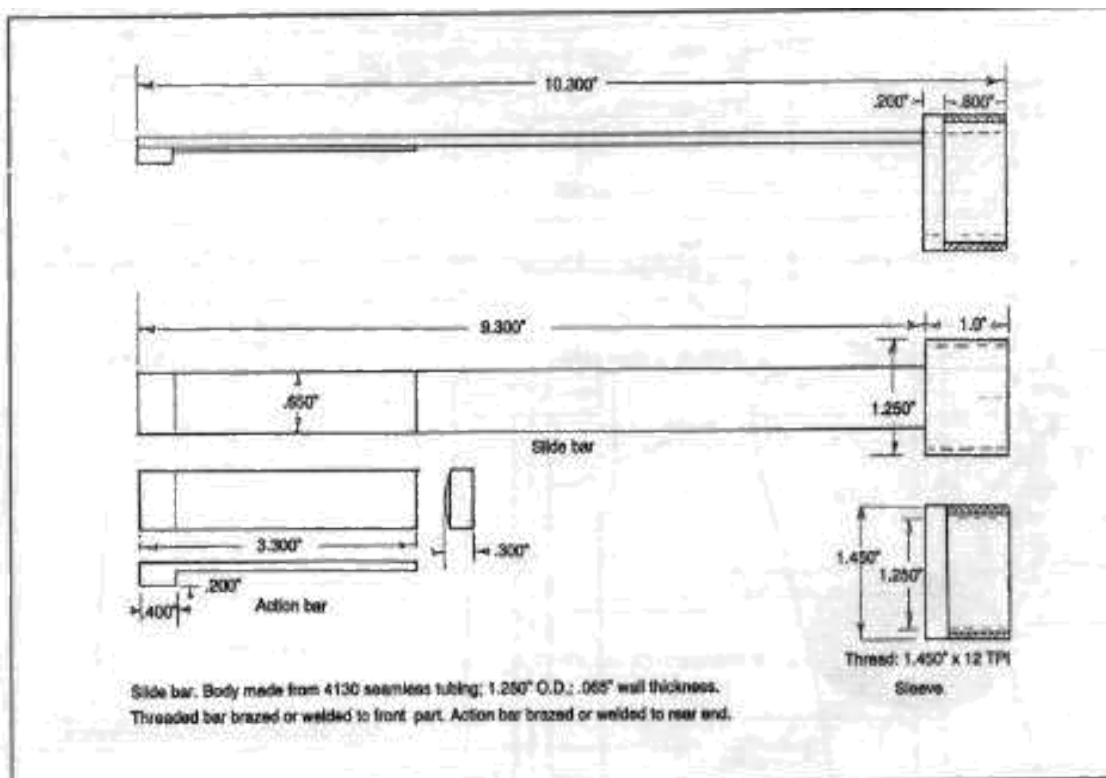

pockets are inserted and the extractors pinned in place. The extractors must spring open enough for a casehead to pass between them. Paint the extreme forward ends of the extractors with a thin coat of lipstick and push the bolt as far into the barrel extension as it will go. The lipstick will mark the barrel end where the relief cuts to clear the extractors will start. These relief cuts must allow the bolthead to rotate to the locked position with a shell in the chamber.

When correctly done, as the bolt body is pushed to the rear, the cam slot turns the rotating pin, causing the bolthead to likewise turn into the unlocked position, whereby the bolt is free to travel to the rear. When the bolt is pulled forward, it rotates the bolthead in the opposite direction into its locked position. The cam surfaces and locking surfaces must be very smooth and free from burrs and tool marks. A worthwhile finishing touch is to coat the mating surfaces with a very fine-grit paste lapping compound and work them together until smooth.

A 1/8 inch wide slot is cut through the top of the threaded end of the receiver. This begins at the forward edge and extends to the rear 1/4

inch. Slide the barrel assembly into the receiver and turn it to the exact position it will be in when finished. Using the slot just cut as a guide, drill a hole 1/8 inch deep into the barrel extension using a No. 31 drill. Taper the end of a short piece of 1/8-inch drill rod slightly and drive it into this hole. It must then be ground off until it only projects about .080 inch above the surface of the barrel extension. This pin serves to locate the barrel consistently during takedown and assembly.

The action bar should be made from 1/4-inch outside diameter seamless tubing with an .065 inch wall thickness. A section at one end is left in the solid diameter and the remainder cut away, leaving a strip 5/8 inch wide. This strip serves as the action bar. A short length of 1 1/2-inch tubing with a .120 wall thickness is threaded, cut to length, slipped over the full diameter portion of the action bar, and silver-soldered in place. The action bar lug is attached to the other end in the same manner.

Make the forend by boring a hole lengthwise through a piece of 2 inch diameter black nylon that is cut to the desired length and the ends squared. The hole should be slightly larger than

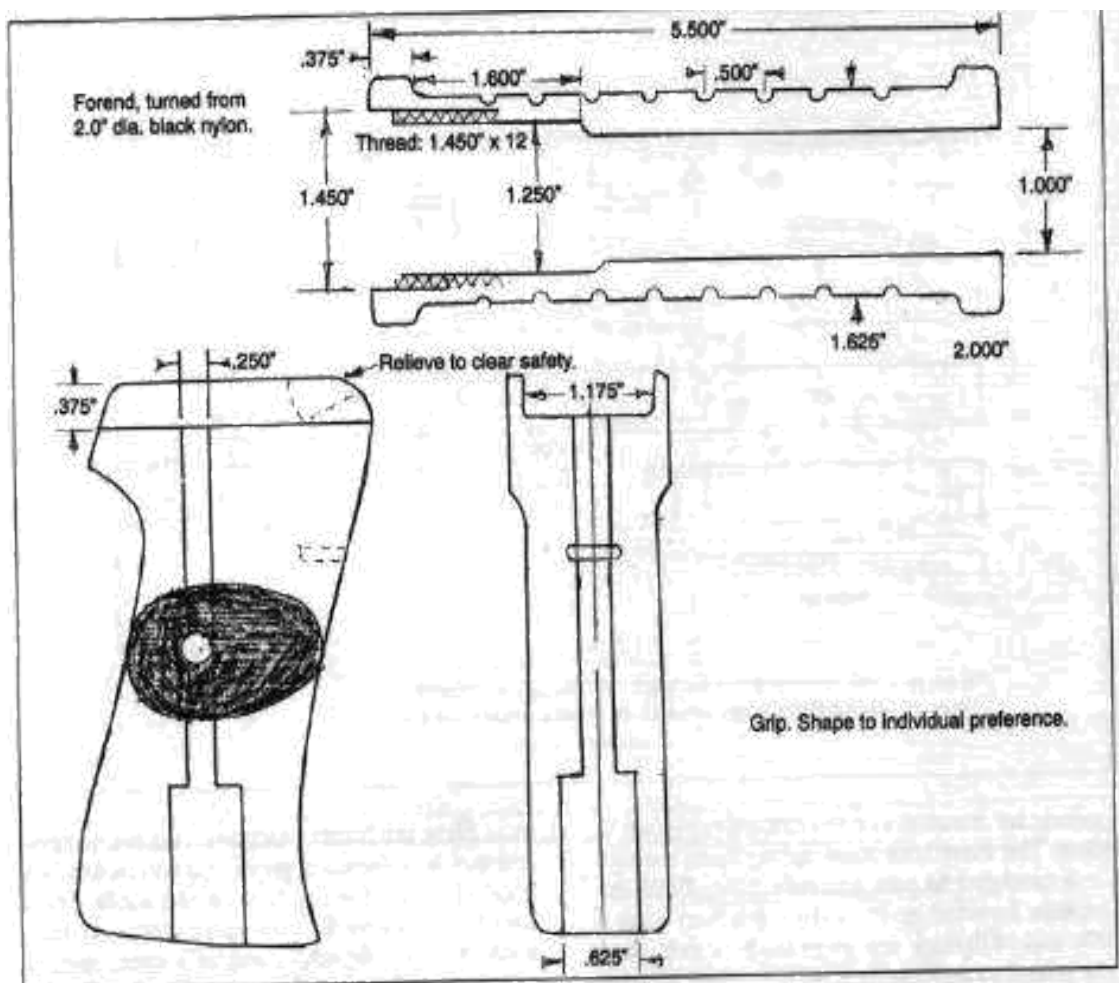

the barrel diameter. One end is bored and threaded to screw onto the action bar. The outside is turned to the shape shown, or whatever contour suits you.

A barrel-retaining nut is made and threaded to screw onto the receiver, bearing against the flange at the front of the barrel extension and holding the barrel in place. The outside diameter should be knurled. Both for appearance and to facilitate tightening and loosening by hand. Knurled surfaces can be enhanced appearance wise by leaving narrow bands along the surface with slight grooves between them and knurling the bands. Using this method, the knurling tool is fed straight in, without sideways movement, on each raised band. This results in sharp, well-defined, even diamonds that may be hard to obtain in a continuous lengthwise knurl.

If the muzzle brake is used, a front sight can be made by cutting an M16 front sight shorter and silver soldering it to the body, or an adjustable front sight can be made as shown in Chapter 15.

If everything is the way it should be, you should be able to put the upper receiver/barrel assembly together now. Screw the forend on the action bar, put the barrel nut over the action bar, and insert the barrel inside. The bolt is added in place and the assembly inserted into the receiver. The barrel nut is screwed onto the receiver, forming a solid assembly.

The rear sight/carrying handle assembly is cut from 14-gauge sheet metal and bent to shape around a form block. The lower legs are bent to shape and a 1/4-inch hole drilled through each of the mounting tabs. It is now located in place

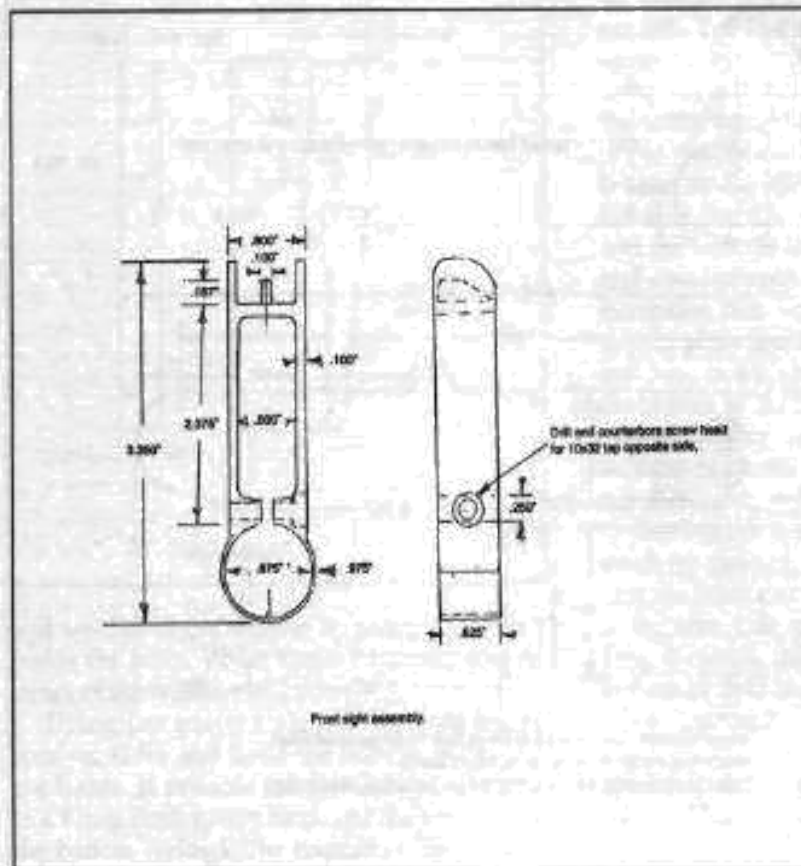
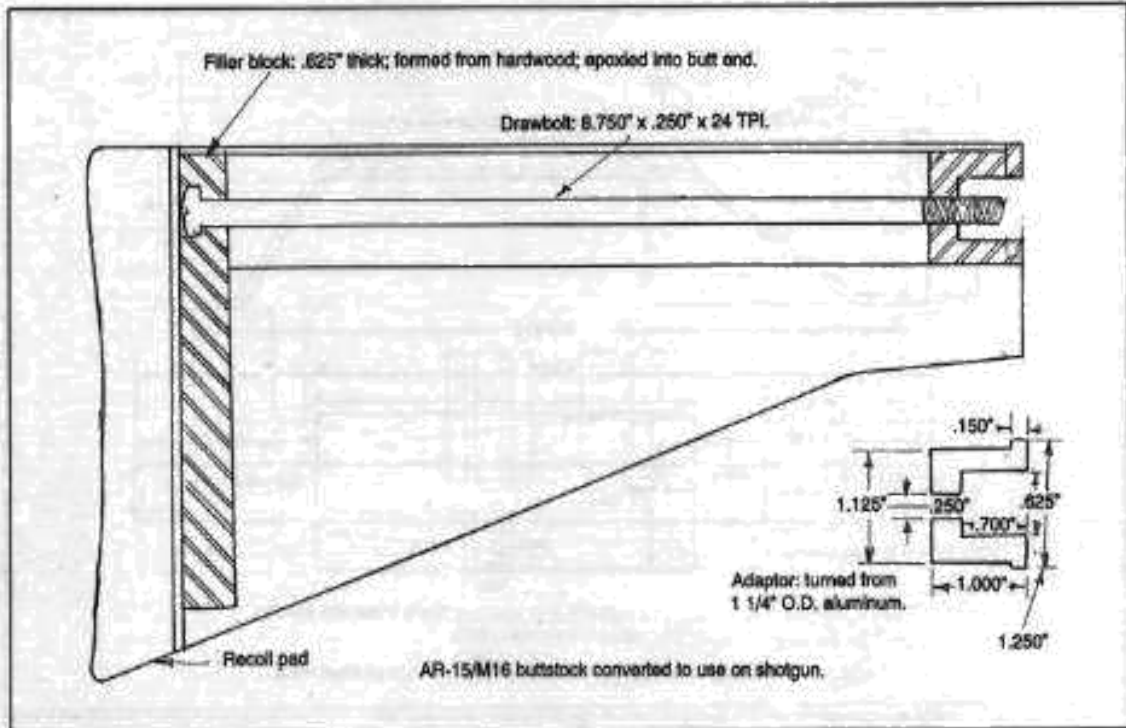

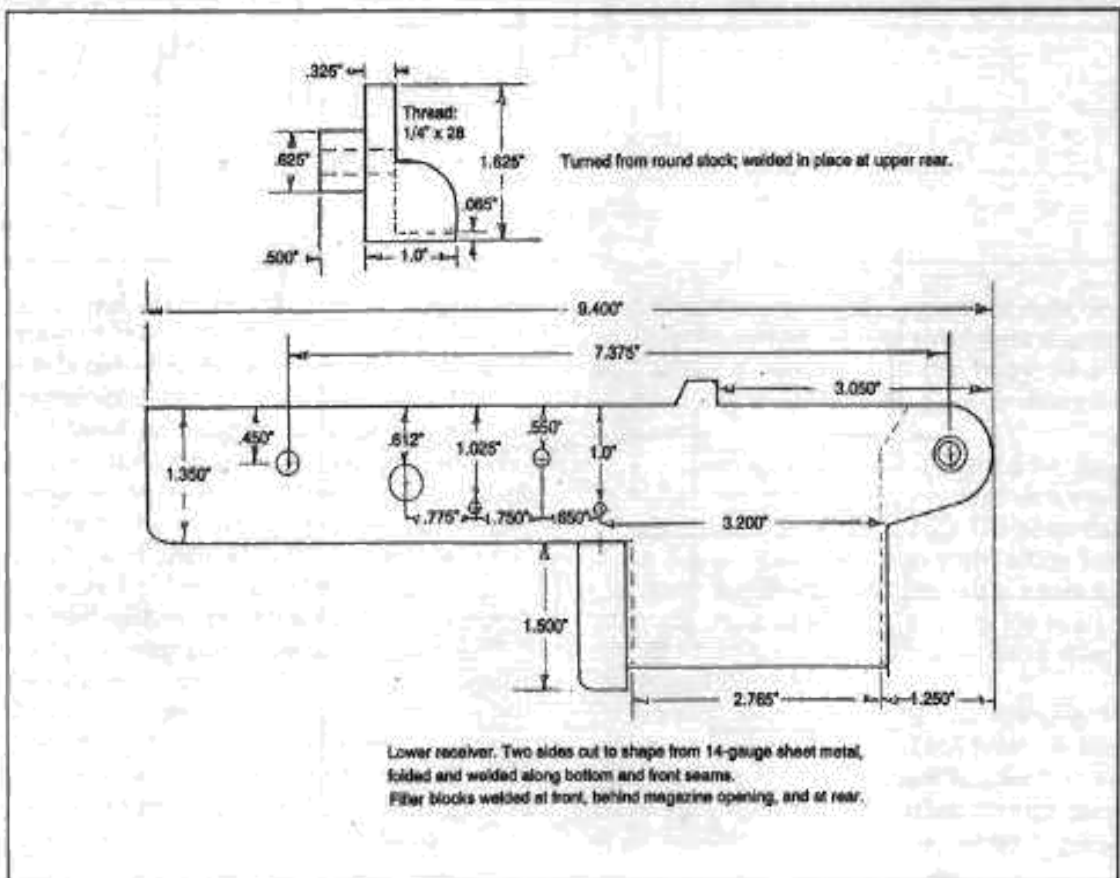
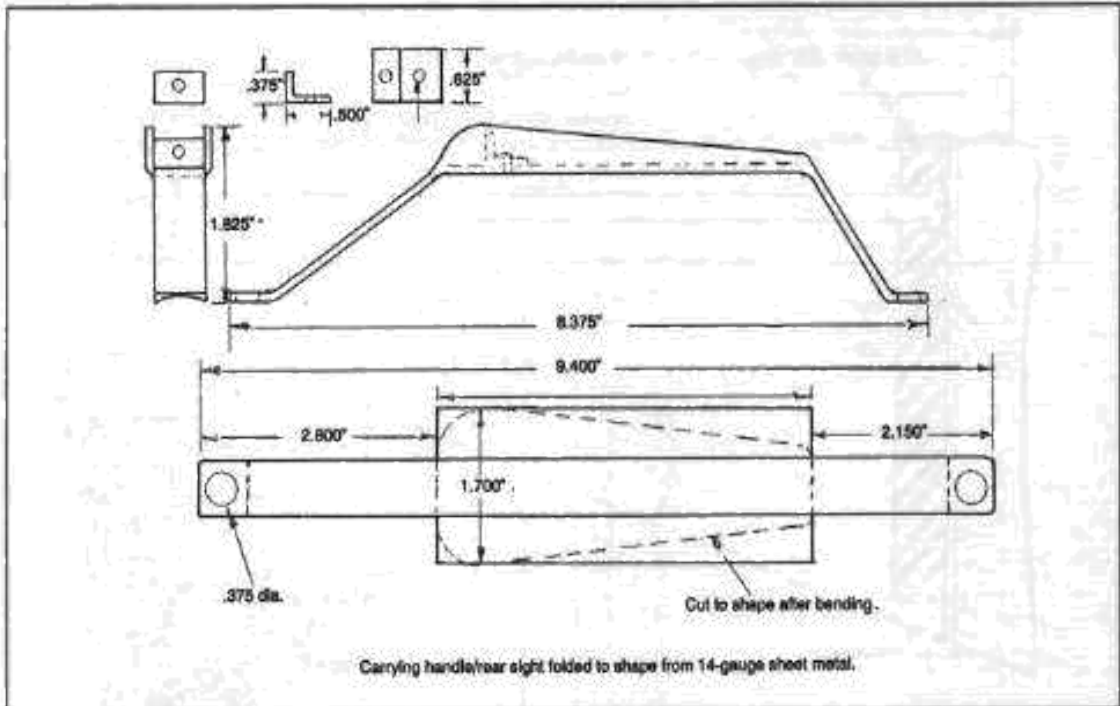

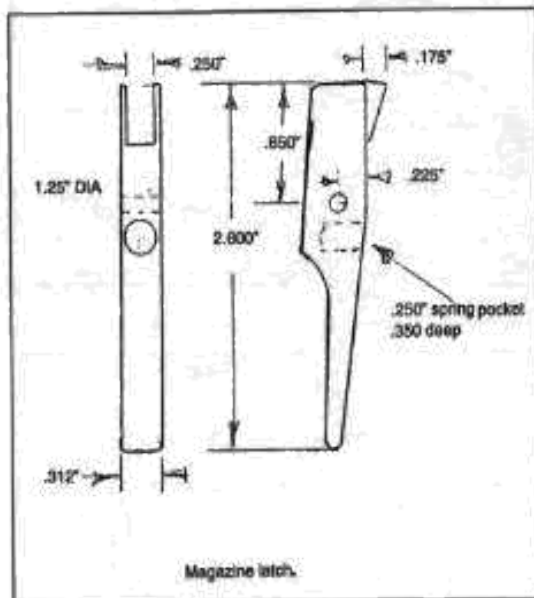
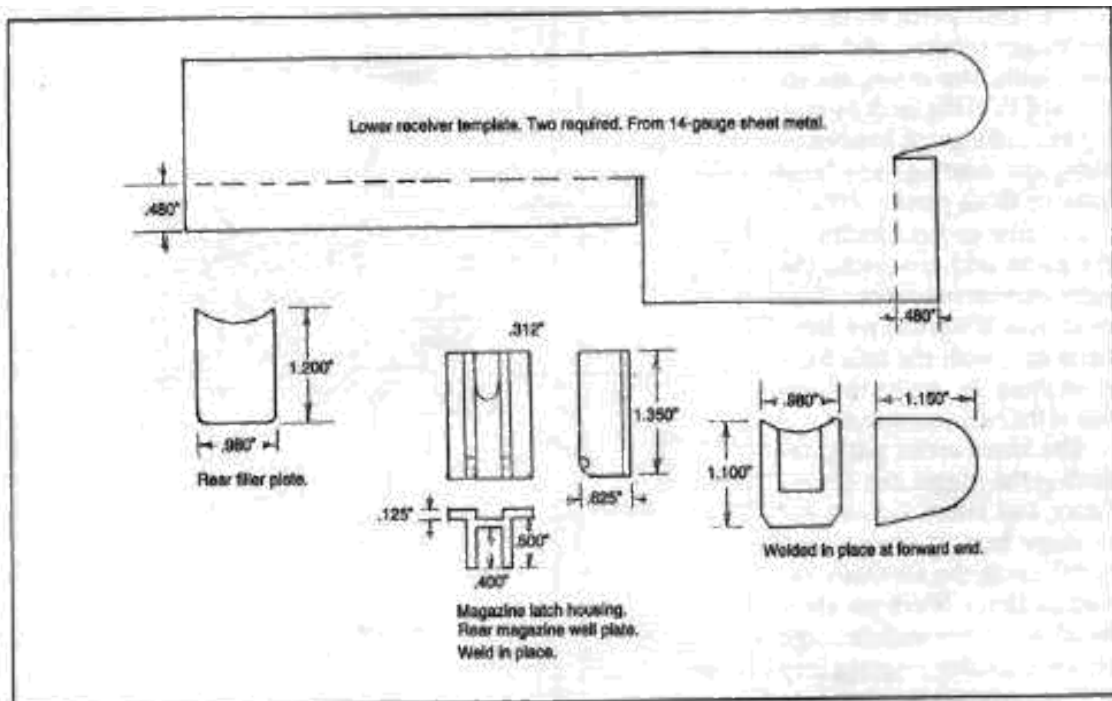

and welded to the receiver by putting the weld inside the holes. When dressed smooth, no evidence of the welding will show.

Using the pattern shown, cut two lower receiver sides and bend the bottom flanges to the inside. If possible these should be clamped to a 1 inch thick spacer block and the seam along the bottom welded. The respective filler blocks

are then welded in place and the seams ground smooth. The upper side that mates against the upper receiver is milled flat and radiused inside using a 1 1/2-inch ball cutter to a close fit with the round-bodied receiver. The front filler block is cut out to mate with the front mounting bracket on the upper receiver. When fitted satisfactorily, both receivers are clamped together and the hole for the crossbolt drilled, threaded, and counterbored for the screw head. The grip mounting bolt hole is located by holding the grip in place and marking the hole through the bolt hole in the grip. This hole extends through the bottom of the lower receiver and through the rear mounting bracket, which is threaded to accommodate the grip bolt that holds the grip, lower receiver, and upper receiver together.

The buttstock is adapted from a surplus M16 stock by turning an aluminum bushing to fit into the front end of the stock and a similar one at the rear. This assembly is held in place by a long drawbolt, made by threading one end of a section of drill rod and welding a head on the other. A screwdriver slot can be cut with a hacksaw. This stock, as it stands, will be too short, so the buttplate is ground flat and a recoil pad added. This will lengthen the stock by as much as an inch.

The small parts, including the trigger, hammer, sear, magazine latch, and others, are cut to shape from flat stock by sawing and milling and finished by filing and sanding. Any holes through these parts should be drilled first and the outline of the parts laid out using the holes as reference points. Make cardboard templates for these parts and, with the hole locations lined up, scribe the outline of the part on the metal.

The sheet metal parts, including the trigger bar, disconnect, and action lock, are cut to shape from 14-gauge sheet metal using the methods described above. Since the sheet metal doesn't contain enough carbon to harden properly, they will require surface, or case hardening. This is easily accomplished using the Kasenit treatment described elsewhere.

The coil springs required can usually be found in hardware stores, auto parts stores, and gunsmith supply houses. I used an M16 hammer spring in this gun, as I have before in a number of gun designs, because it is cheap, dependable, and available. These are advertised by surplus parts suppliers at prices from \$1 up, which I consider a bargain.

The magazine latch, or retainer, is fitted easily by first drilling the hinge pin hole through the lower receiver. Then, with the magazine in place, the latch is placed in position with the upper end bearing against the block on the back of the magazine and the hole drilled using the hole through the receiver as a drill bushing. This should require little or no further fitting.

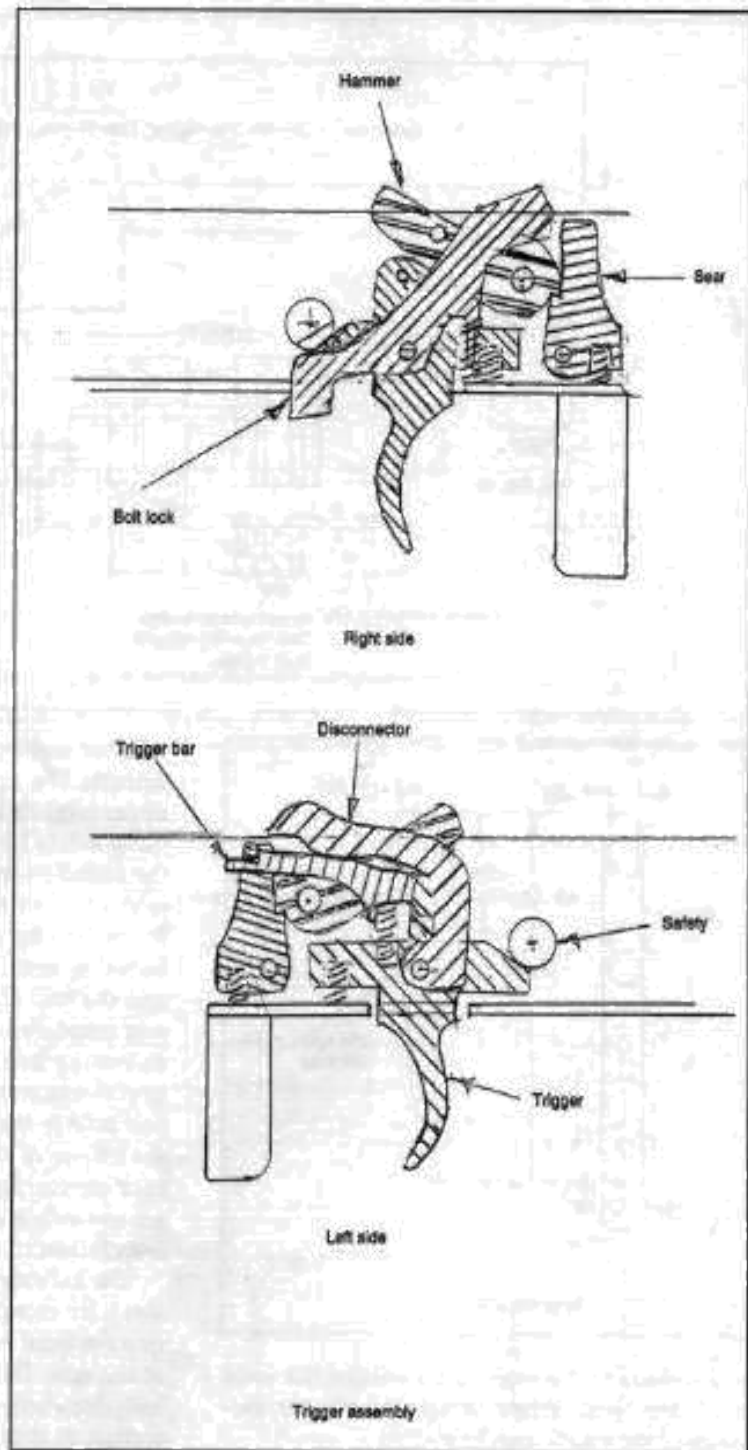

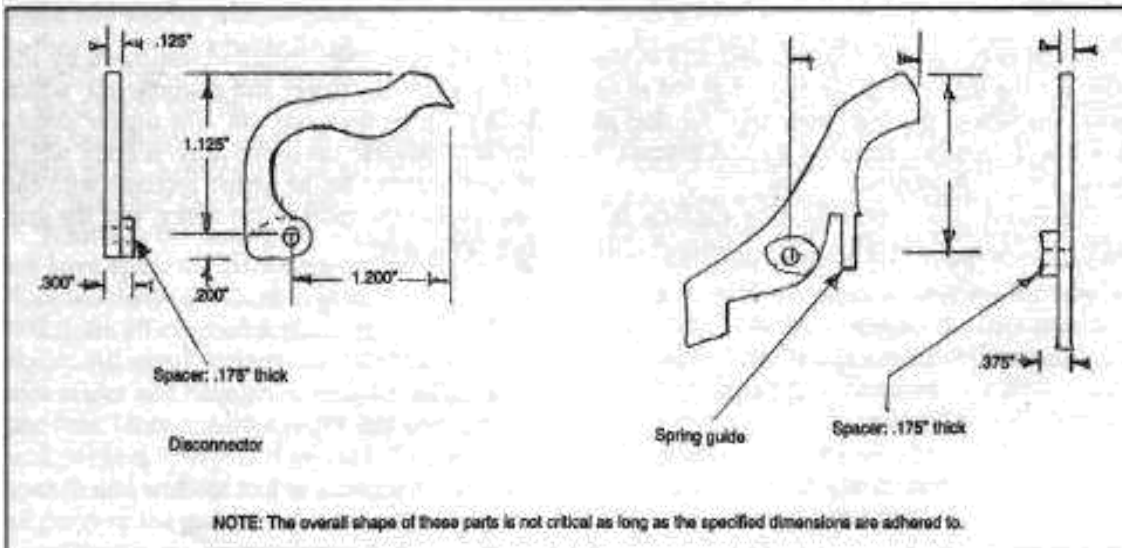
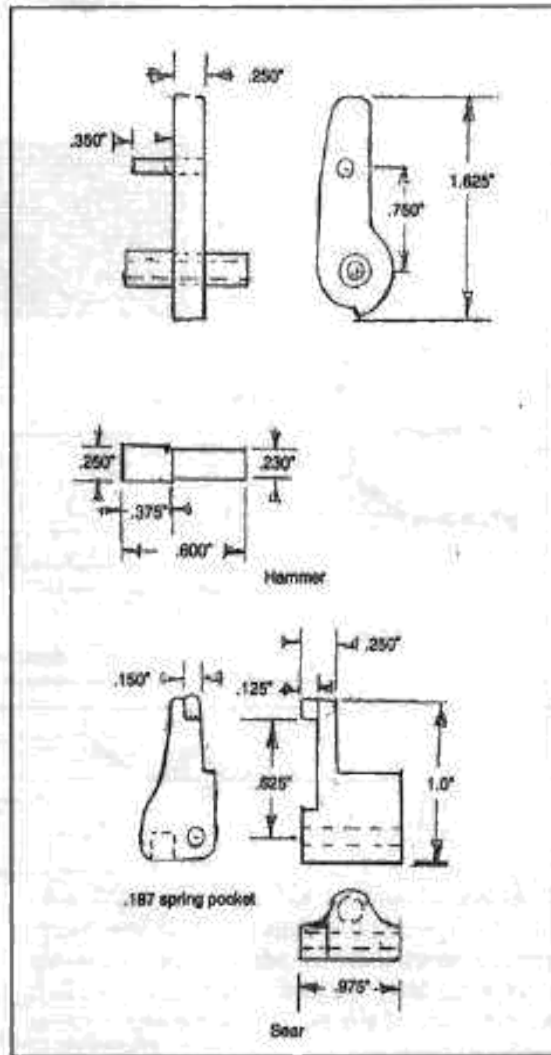
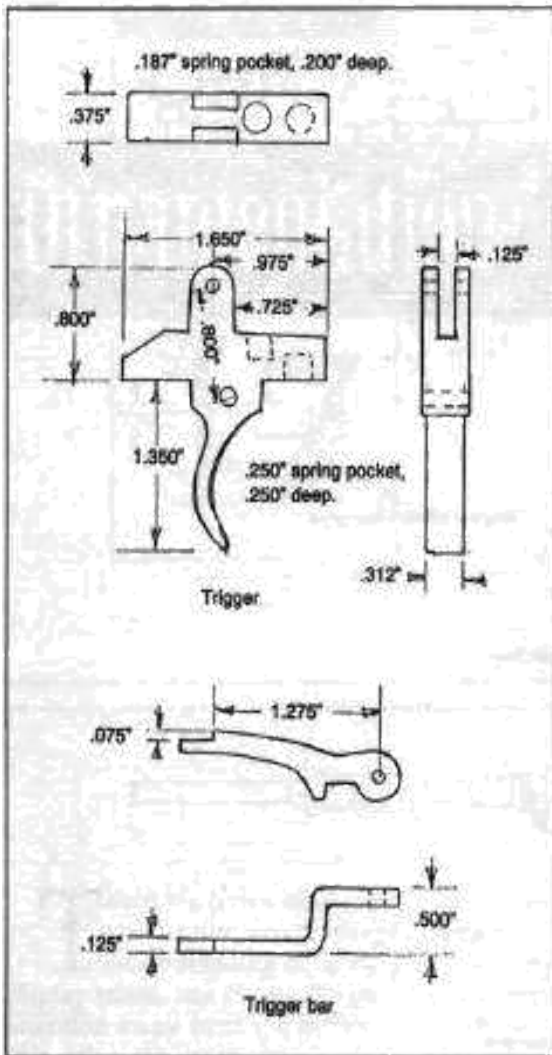

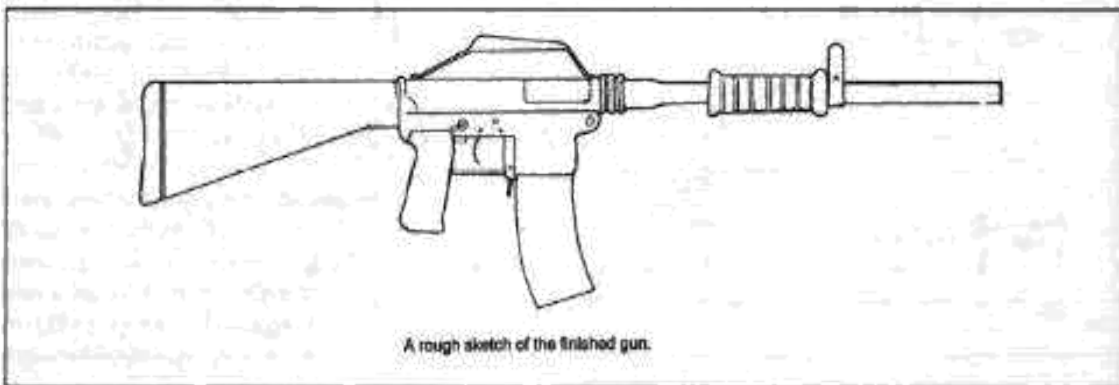
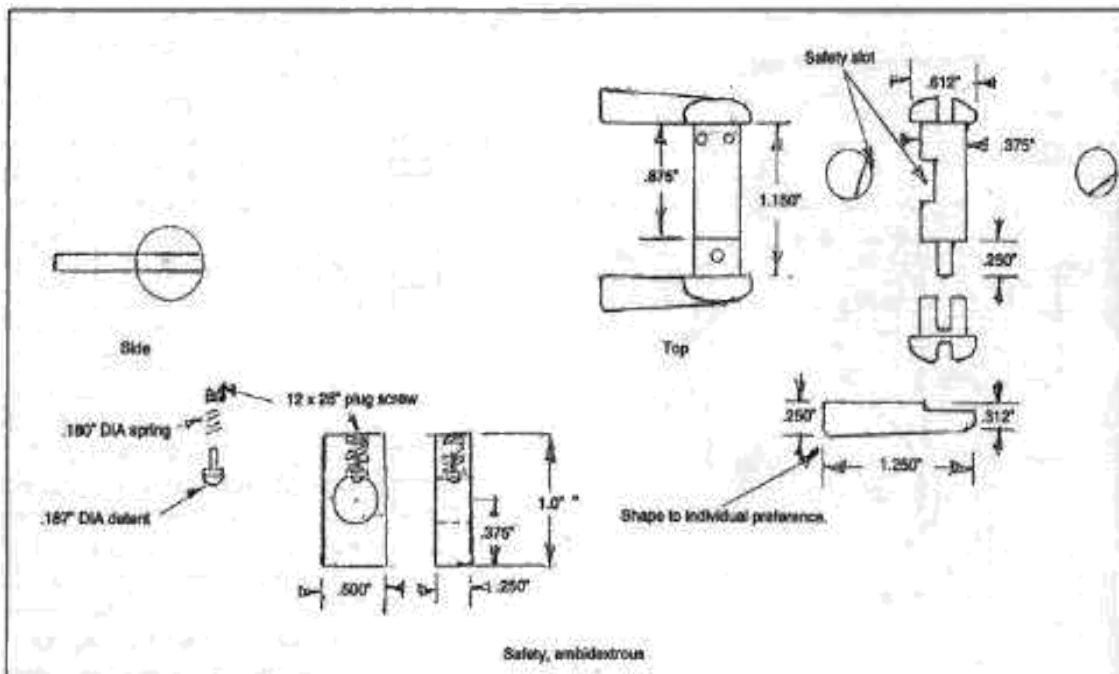

A slot is cut with a 1/8-inch end mill in the grip for the rear end of the trigger guard to fit into. The tabs at the front mate into the slots in the lower receiver, forming a solid assembly when the grip is secured in place.

Assembly is accomplished by pinning the sear in place, followed by the hammer. The

action lock is then installed, followed by the safety, then the trigger and disconnect, which both pivot on the same pin. The trigger assembly is installed in the lower receiver body, which is then secured to the upper receiver with the crossbolt at the front of the action and the grip bolt at the rear.

Improvised Silencer

A DIY silencer is easily one of the most handy inventions ever. Not only do these silencers (aka suppressors) help you keep your location hidden from an attacker, but they are also a great way to sneak up on your food while hunting. And, when you can make them with your own hands, they're even better.

So many suppressors are crazy expensive these days. But, when making them yourself, you often spend less and still stay 100% legal. And that's a combination that can make most any carrier happy.

A way you can make your own DIY silencer is to build it out of an oil filter. That's right – the very same oil filter you would use in your vehicle can also do a great deal to lower the volume of the blast every time you shoot. In fact, you can even use this on a variety of firearms, making it a shooting essential.

First, it's important to have the right equipment. You need an oil filter, an adapter, and a threaded fitting on the firearm. Here's a visual:

HOW THIS WORKS

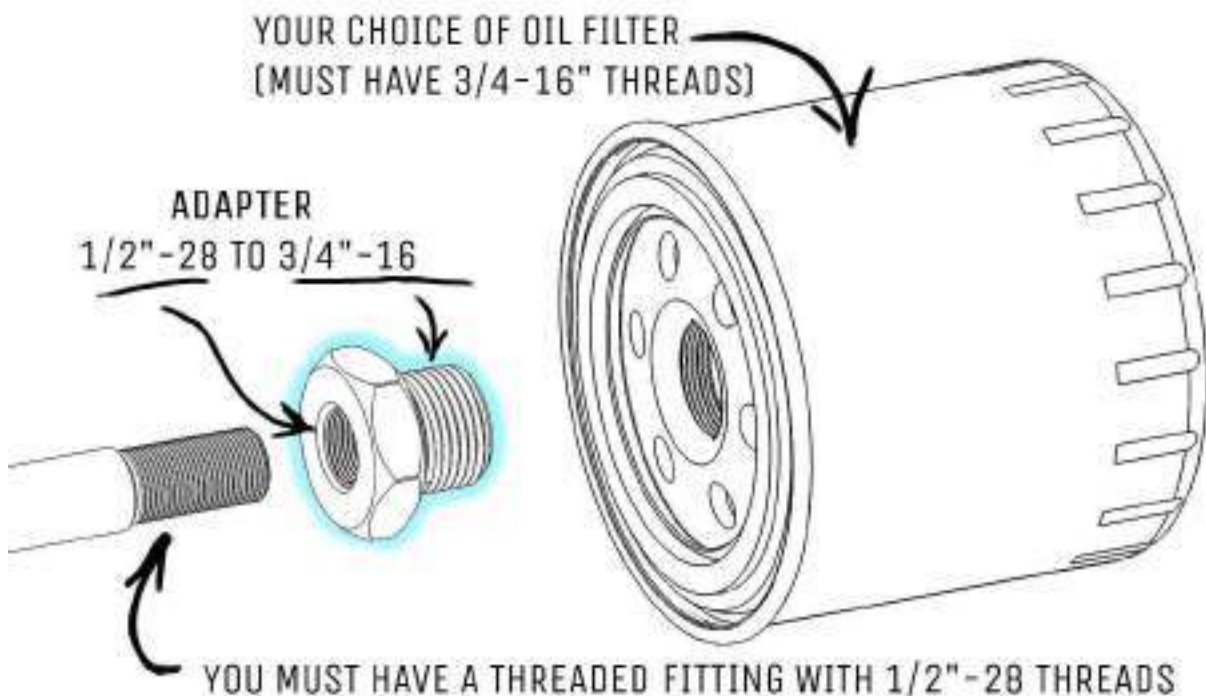

FITS THESE COMMON LARGER-SIZED OIL FILTERS



BOSCH 3500



FRAM PH8A



WIX 51068



MICROGARD MGL8994

MICROGARD MGL51355

MICROGARD MGL51515



Universal Thread Adapter for AR
1/2-28 RH Filter Adapter Black
Oxide Finish 3/4"-16, 13/16"-16,
3/4" NPT – LIFETIME WARRANTY.



1/2-28 to 3/4-16 Threaded Adapter
Fitting Automotive -Aluminum.

CHAPTER XII: SPECIALIZED CLOTHING

Ballistic Armor

Ballistic armor (also known as bullet-proof armor and body armor) will protect the wearer from many types of bullets and shrapnel. Larger caliber bullets and armor piercing (AP) bullets will however pierce through it. Ballistic armor is legal in most regions such as in the EU and the USA, and can be bought from police surplus. The most commonly needed pieces of armor are the vest and the helmet. Other parts can also be worn, such as a ballistic backpack. It is advised to be weary during combat with the ballistic armor on. Any bullet could hit you on the points unprotected by the ballistic armor, or someone with AP bullets could shoot you down. The ballistic armor could also reduce after multiple rounds. It should also be known that being shot while wearing ballistic armor hurts a lot.

There are multiple levels of ballistic armor. There are 6 levels that are written about in this section. Level I is very weak and can withstand rounds from the smallest common calibers. Level II-A is stronger and can withstand rounds from common handguns. Level II-A and level II are very similar in strength. Level III-A can withstand rounds from larger handguns and 12 gauge shotgun slugs. Level III is the second most powerful and can withstand rounds from proper rifles. Level IV is the strongest and can withstand high caliber rounds.

It is advised to use level III (or "level III+" if possible) ballistic armor for most operations. Use level IV ballistic armor if sniper fire from the opponents is expected.

NIJ Standard - D108.01 BALLISTIC RESISTANT PROTECTIVE MATERIALS						
ARMOR TYPE	WEAPON	TEST AMMUNITION	NOMINAL BULLET MASS	SUGGESTED BARREL LENGTH	REQUIRED BULLET VELOCITY	REQUIRED HITS PER ARMOR SPECIMEN
I		22 LRHV Lead 38 Special RN Lead	2.6 g 40 gr 10.2 g 158 gr	15 to 16.5 cm 6 to 6.5 in 15 to 16.5 cm 6 to 6.5 in	320 ± 12 m/s 1050 ± 40 ft/s 269 ± 15 m/s 850 ± 50 ft/s	5 5
II-A		357 Magnum JSP 9 mm FMJ	10.2 g 158 gr 8.0 g 124 gr	10 to 12 cm 4 to 4.75 in 10 to 12 cm 4 to 4.75 in	381 ± 15 m/s 1250 ± 50 ft/s 332 ± 12 m/s 1090 ± 40 ft/s	5 5
II		357 Magnum JSP 9 mm FMJ	10.2 g 158 gr 8.0 g 124 gr	15 to 16.5 cm 6 to 6.5 in 10 to 12 cm 4 to 4.75 in	425 ± 15 m/s 1395 ± 50 ft/s 358 ± 12 m/s 1175 ± 40 ft/s	5 5
III-A		44 Magnum Lead BWC Gas Checked 9 mm FMJ	15.55 g 240 gr 8.0 g 124 gr	14 to 15 cm 5.5 to 6.25 in 24 to 25 cm 9.5 to 10.25 in	426 ± 15 m/s 1400 ± 50 ft/s 426 ± 15 m/s 1400 ± 50 ft/s	5 5
III		7.62 mm 308 Winchester FMJ	9.7 g 150 gr	56 cm 22 in	838 ± 15 m/s	5
IV		30-06 AP	10.8 g 166 gr	56 cm 22 in	838 ± 15 m/s 2850 ± 50 ft/s	1

The higher levels are made of solid alloy, ceramic composite or special plastic plates fitted in the plate carrier which is attached to the vest. The plates are to be attached to both the front and back of the wearer.

The vast majority of people prefer curved plates instead of flat plates. Always apply anti-spall coating to the steel plates. These sorts of armor are called 'hard armor'. 'Soft armor' is similar to fabric and is not as strong as hard armor. Kevlar is soft armor. It is advised to use soft armor in the gaps of the hard armor to protect from shrapnel caused by higher caliber bullets colliding with the environment. Some soft armor can protect the you from knives but check the ratings. Research what the plate or kevlar that is to be bought can withstand before buying. Armor will be most effective when utilized against opponents without the appropriate equipment. Police in safer regions will have to wait for special forces to arrive which may take a long time.

Improvised Ballistic Armor

Note: This section was largely written by Cpl. Vernon Itas.

Your life is in your hands: research strong materials and test a sample of your armor before heading into combat. The process below also works for making helmets and protecting other areas of the body, though make sure you are nimble enough to carry out your mission. Test the body armor before usage.

Materials:

- 1) Ceramic Floor Tile (PEI5)
- 2) Medium Weight Denim
- 3) Construction Adhesive
- 4) Galvanized sheet metal (used for roof flashing)

Step 1: Cut the Denim to size. A 6" x 6" Tile will require a piece of denim that is 19" x 19". The extra one inch comes from the excess material required to account for the folding of the denim.

Step 2: Add the Construction Adhesive. Use a putty knife to spread out the liquid nails or construction adhesive and push it into the fabric. Step 3: Place a PEI 5 Ceramic Tile in the center of the denim fabric.

Step 4: Continue to add construction adhesive to the denim and fold it onto itself. The final plate will have one layer in front of the ceramic tile, and 8 layers of construction adhesive on the back.

Step 5: Attach the sheet metal to the back of the plate.

Camouflage

Note: This section is largely from the Werwolf combat manual translated by Lt. Michael C. Fagnon.

Proper utilization of the terrain and camouflage will enable one to find concealment from the enemy in order to deceive, dupe, and surprise him. One must offer only the very smallest and poorly visible target possible in case of discovery. Camouflage against air view must never be forgotten. Utilization of the terrain requires the skillful use of all

possibilities of cover and concealment, and consideration of the color of the back and underground.

Sunlight shadows must also be considered. The guerrilla must always be intent on offering only a small target. Camouflage is achieved by adapting to the surroundings with the help of natural and artificial means and by avoiding noticeable movements. The following points concerning cover and concealment must be remembered.

a) Cover for campsites, halt, and rest areas during the march and when advancing is offered by mountains, hills, boulders, valleys, gulches, forests, hedges, bushes, cornfields, houses, barns, walls, fences, ditches, dirt piles, etc. The guerrilla sneaking up on enemy guards must make use of even the smallest depressor, furrow, dirt and rock-pile, mole mound, and grass bundle for cover and concealment. Here can be seen the use of a small cover:



b) Consideration of the color of the back and underground is necessary: for example, the grey-green uniform offers no camouflage against light yellow-colored sand. Especially to be considered is the contour against the sky which the guerrilla offers to the eye of the enemy when advancing over hills and even the smallest elevations. This contour effect is not only a give-away at daytime, but also during bright nights. Shadows and the point of view of the enemy should also be considered. Here can be seen the consideration of back and underground in 3 examples:

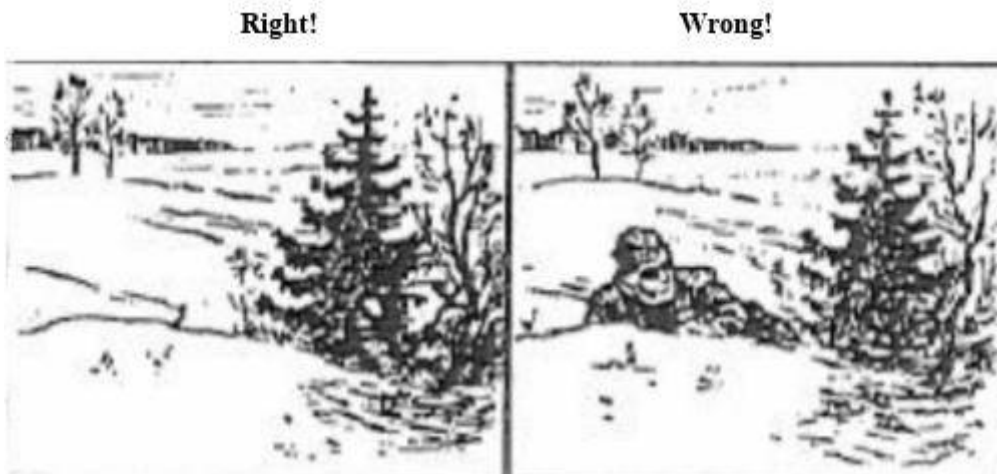



Right!

Wrong!

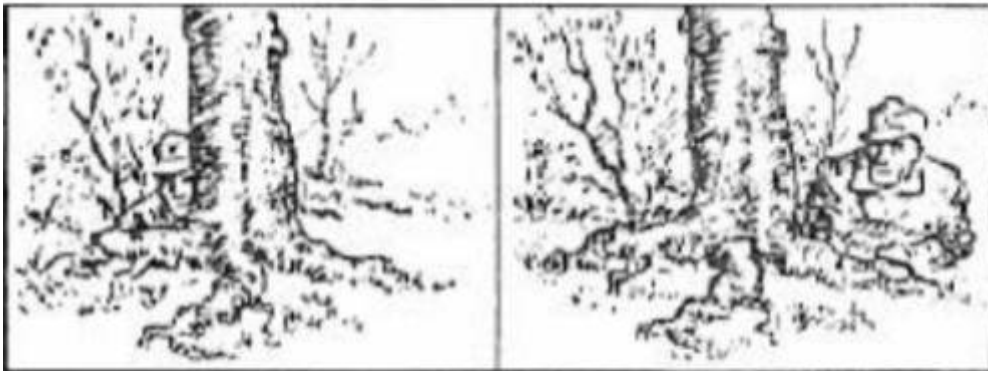

c) The most important natural camouflage means are: small trees, twigs, grass, moss, wheat, herbs, leaves, etc. Face and hands may be subdued with dirt, soot, or grease paint in some environments, or blackboard chalk or flour during winter. When camouflaging campsites, it is advisable to replant small trees, bushes, grass and moss. The camouflage thus becomes more natural and does not wither as fast.

d) The most common artificial camouflage means are: the tent canvas, blankets, camouflaged uniforms, camouflaged ponchos, large camouflaged nets to cover holes, and small camouflaged nets to cover the face and the shoulders. Camouflage ponchos and snow ponchos are easily self made. Old clothing pieces, fishing nets, and rope are also of value. These artificial camouflage means may be supplemented with natural means like twigs, grass, etc. Different colored rags and bundles of bush and paper can be tied to nets. It is useful eyelets and bands to the cap, so that camouflage may be quickly attached and changed.

Guerrilla units almost always march at night. Bad weather must be exploited. They avoid dwellings, roads, and paths that are often used. When forced to use paths and tracks, the

greatest caution must be exercised; marching at the edge or parallel of the path lessens the danger. The march of the guerrilla units must be a steady cautious advance. The guerrilla must make as little noise as possible.



On soft ground.

On hard ground.

On grass.

There are many different patterns for camouflage. Here are some good ones:

- Disruptive Pattern Material (DPM).
- Finnish M05.
- Rhodie Brushstroke.
- US M81 Woodland.

CHAPTER XIII: SNIPER TRAINING

Note: This is taken from the FM 23-10 sniper training manual used by the Headquarters Department of the Army in the USA. The full document can be accessed here:

https://ia800308.us.archive.org/21/items/milmanual-fm-23-10-sniper-training/fm_23-10_sniper_training.pdf

Introduction

This field manual provides information needed to train and equip snipers and to aid them in their missions and operations. It is intended for use by commanders, staffs, trainers, snipers, and soldiers at training posts, Army schools, and units.

This manual is organized as a reference for snipers and leads the trainer through the material needed to conduct sniper training. Subjects include equipment, weapon capabilities, fundamentals of marksmanship and ballistics, field skills, mission planning, and skill sustainment. The left-handed firer can become a sniper, but all material in this book is referenced to the right-handed firer.

The primary mission of a sniper in combat is to support combat operations by delivering precise long-range fire on selected targets. By this, the sniper creates casualties among enemy troops, slows enemy movement, frightens enemy soldiers, lowers morale, and adds confusion to their operations. The secondary mission of the sniper is collecting and reporting battlefield information.

a. A well-trained sniper, combined with the inherent accuracy of his rifle and ammunition, is a versatile supporting arm available to an infantry commander. The importance of the sniper cannot be measured simply by the number of casualties he inflicts upon the enemy. Realization of the sniper's presence instills fear in enemy troop elements and influences their decisions and actions. A sniper enhances a unit's firepower and augments the varied means for destruction and harassment of the enemy. Whether a sniper is organic or attached, he will provide that unit with extra supporting fire. The sniper's role is unique in that it is the sole means by which a unit can engage point targets at distances beyond the effective range of the M16 rifle. This role becomes more significant when the target is entrenched or positioned among civilians, or during riot control missions. The fires of automatic weapons in such operations can result in the wounding or killing of noncombatants.

b. Snipers are employed in all levels of conflict. This includes conventional offensive and defensive combat in which precision fire is delivered at long ranges. It also includes combat patrols, ambushes, countersniper operations, forward observation elements, military operations in urbanized terrain, and retrograde operations in which snipers are part of forces left in contact or as stay-behind forces.

In light infantry divisions, the sniper element is composed of six battalion personnel organized into three 2-man teams. The commander designates missions and priorities of targets for the team and may attach or place the team under the operational control of a

company or platoon. They may perform dual missions, depending on the need. In the mechanized infantry battalions, the sniper element is composed of two riflemen (one team) located in a rifle squad. In some specialized units, snipers may be organized according to the needs of the tactical situation.

a. Sniper teams should be centrally controlled by the commander or the sniper employment officer. The SEO is responsible for the command and control of snipers assigned to the unit. In light infantry units, the SEO will be the reconnaissance platoon leader or the platoon sergeant. In heavy or mechanized units, the SEO may be the company commander or the executive officer. The duties and responsibilities of the SEO areas follows:

- (1) To advise the unit commander on the employment of snipers.
- (2) To issue orders to the team leader.
- (3) To assign missions and types of employment.
- (4) To coordinate between the sniper team and unit commander.
- (5) To brief the unit commander and team leaders.
- (6) To debrief the unit commander and team leaders.
- (7) To train the teams.

b. Snipers work and train in 2-man teams. One sniper's primary duty is that of the sniper and team leader while the other sniper serves as the observer. The sniper team leader is responsible for the day-to-day activities of the sniper team. His responsibilities areas follows:

- (1) To assume the responsibilities of the SEO that pertain to the team in the SEO'S absence.
- (2) To train the team.
- (3) To issue necessary orders to the team.
- (4) To prepare for missions.
- (5) To control the team during missions.

c. The sniper's weapon is the sniper weapon system. The observer has assault rifles, which gives the team greater suppressive fire and protection. Night capability is enhanced by using night observation devices.

The basic guidelines used to screen sniper candidates are as follows:

- (1) Marksmanship. The sniper trainee must be an expert marksman. Repeated annual qualification as expert is necessary. Successful participation in the annual competition- in-arms program and an extensive hunting background also indicate good sniper potential.
- (2) Physical condition. The sniper, often employed in extended operations with little sleep, food, or water, must be in outstanding physical condition. Good health means better reflexes, better muscular control, and greater stamina. The self-confidence and control that come from athletics, especially team sports, are definite assets to a sniper trainee.
- (3) Vision. Eyesight is the sniper's prime tool. Therefore, a sniper must have 20/20 vision or vision correctable to 20/20. However, wearing glasses could become a liability if glasses are lost or damaged. Color blindness is also considered a liability to the sniper, due to his inability to detect concealed targets that blend in with the natural surroundings.
- (4) Smoking. The sniper should not be a smoker or use smokeless tobacco. Smoke or an un-suppressed smoker's cough can betray the sniper's position. Even though a sniper may not smoke or use smokeless tobacco on a mission, his refrainment may cause nervousness and irritation, which lowers his efficiency.

(5) Mental condition. When commanders screen sniper candidates, they should look for traits that indicate the candidate has the right qualities to be a sniper. The commander must determine if the candidate will pull the trigger at the right time and place. Some traits to look for are reliability, initiative, loyalty, discipline, and emotional stability. A psychological evaluation of the candidate can aid the commander in the selection process.

(6) Intelligence. A sniper's duties require a wide variety of skills. He must learn the following:

- Ballistics.
- Ammunition types and capabilities.
- Adjustment of optical devices.
- Communications operation and procedures.
- Observation and adjustment of mortar and artillery fire.
- Land navigation skills.
- Military intelligence collecting and reporting.
- Identification of threat uniforms and equipment.

b. In sniper team operations involving prolonged independent employment, the sniper must be self-reliant, display good judgment and common sense. This requires two other important qualifications: emotional balance and field craft.

(1) Emotional balance. The sniper must be able to calmly and deliberately kill targets that may not pose an immediate threat to him. It is much easier to kill in self-defense or in the defense of others than it is to kill without apparent provocation. The sniper must not be susceptible to emotions such as anxiety or remorse. Candidates whose motivation toward sniper training rests mainly in the desire for prestige may not be capable of the cold rationality that the sniper's job requires.

(2) Field craft. The sniper must be familiar with and comfortable in a field environment. An extensive background in the outdoors and knowledge of natural occurrences in the outdoors will assist the sniper in many of his tasks. Individuals with such a background will often have great potential as a sniper.

Each member of the sniper team has specific responsibilities. Only through repeated practice can the team begin to function properly. Responsibilities of team members areas follows:

a. The sniper—

- Builds a steady, comfortable position.
- Locates and identifies the designated target.
- Estimates the range to the target.
- Dials in the proper elevation and windage to engage the target.
- Notifies the observer of readiness to fire.
- Takes aim at the designated target.
- Controls breathing at natural respiratory pause.
- Executes proper trigger control.
- Follows through.
- Makes an accurate and timely shot call.
- Prepares to fire subsequent shots, if necessary.

b. The observer—

- Properly positions himself.
- Selects an appropriate target.
- Assists in range estimation.

- Calculates the effect of existing weather conditions on ballistics.
- Reports sight adjustment data to the sniper.
- Uses the observation telescope for shot observation.
- Critiques performance.

A sniper team must be able to move and survive in a combat environment. The sniper team's mission is to deliver precision fire. This calls for a coordinated team effort. Together, the sniper and observer—

- Determine the effects of weather on ballistics.
- Calculate the range to the target.
- Make necessary sight changes.
- Observe bullet impact.
- Critique performance before any subsequent shots.

Equipment

This section describes the equipment necessary for the sniper to effectively perform his mission. The sniper carries only what is essential to successfully complete his mission. He requires a durable rifle with the capability of long-range precision fire.

Sling Adjustment The sling helps hold the weapon steady without muscular effort. The more the muscles are used the harder it is to hold the weapon steady. The sling tends to bind the parts of the body used in aiming into a rigid bone brace, requiring less effort than would be necessary if no sling were used. When properly adjusted, the sling permits part of the recoil of the rifle to be reabsorbed by the nonfiring arm and hand, removing recoil from the firing shoulder.

(1) The sling consists of two different lengths of leather straps joined together by a metal D ring (Figure 2-8). The longer strap is connected to the sling swivel on the rear stud on the forearm of the rifle. The shorter strap is attached to the sling swivel on the buttstock of the rifle. There are two leather loops on the long strap known as keepers. The keepers are used to adjust the tension on the sling. The frogs are hooks that are used to adjust the length of the sling.

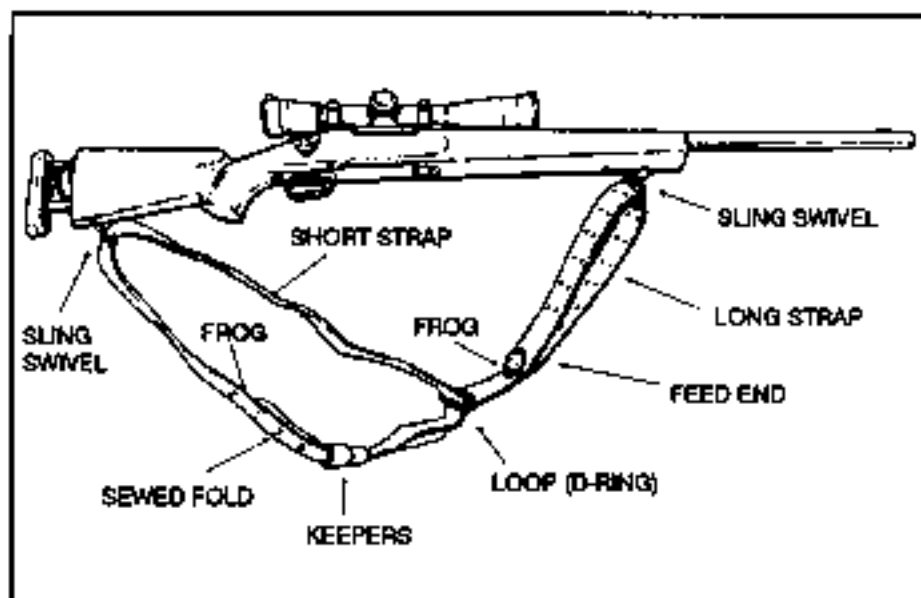

Figure 2-8. Leather Sling.

- (2) To adjust the sling, the sniper disconnects the sling from the buttstock swivel. Then, he adjusts the length of the metal D ring that joins the two halves of the sling. He then makes sure it is even with the comb of the stock when attaching the sling to the front swivel.
- (3) The sniper adjusts the length of the sling by placing the frog on the long strap of the sling in the 4th to the 7th set of adjustment holes on the rounded end of the long strap that goes through the sling swivel on the forearm (Figure 2-10).
- (4) After adjusting the length, the sniper places the weapon on his firing hip and supports the weapon with his firing arm. The sniper turns the weapon 2-10. Adjusting the length of the sling with his firing arm. The sniper turns the sling away from him 90 degrees and inserts his nonfiring arm.
- (5) The sniper slides the loop in the large section of the sling up the nonfiring arm until it is just below the armpit (Figure 2-11). He then slides both leather keepers down the sling until they bind the loop snugly round the nonfiring arm.
- (6) The sniper moves his nonfiring hand from the outside of the sling to the inside of the sling between the rifle and the sling. The sniper then grasps the forearm of the weapon, just behind the sling swivel with his nonfiring hand. He forces it outward and away from his body with the nonfiring hand (Figure 2-12).
- (7) The sniper pulls the butt of the weapon into the pocket of his shoulder with the firing hand. He then grasps the weapon at the small of the stock and begins the aiming process.

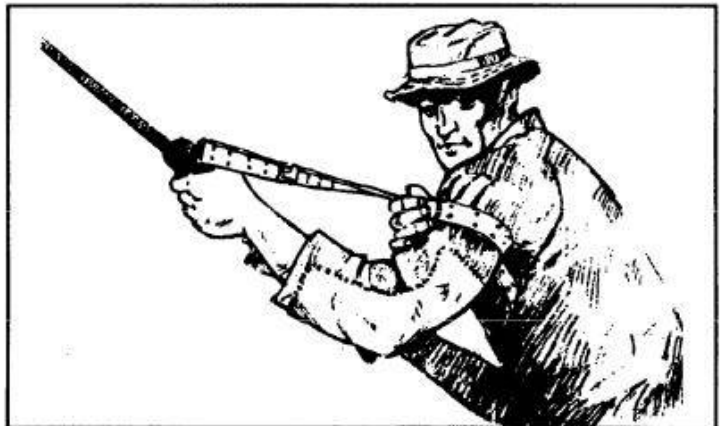

Figure 2-11. Placing the sling around the nonfiring arm.

2-10. Adjusting the length of the sling.

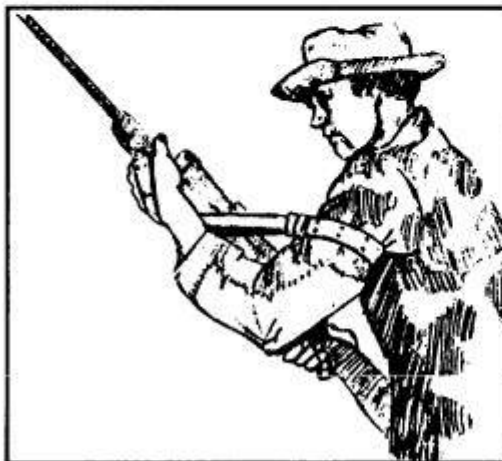

Figure 2-12. Proper placement of the sling.

For optimal sniping, the rifle should always be cleaned and lubricated before use. One must also recognize the environment around the rifle as for it not to degrade during the operation. There are measures that can be taken against such factors.

Cold Climates: In temperatures below freezing, the rifle must be kept free of moisture and heavy oil, both of which will freeze, causing the working parts to freeze or operate sluggishly. The rifle should be stored in a room with the temperature equal to the outside temperature. When the rifle is taken into a warm area, condensation occurs, thus requiring a thorough cleaning and drying before taking it into the cold. Otherwise, the condensation causes icing on exposed metal parts and optics. The firing pin should be disassembled and cleaned thoroughly with a decreasing agent. It should then be lubricated with CLP. Rifle grease hardens and causes the firing pin to fall sluggishly.

Salt Water Exposure: Saltwater and saltwater atmosphere have extreme and rapid corrosive effects on the metal parts of the rifle. During periods of exposure, the rifle must be checked and cleaned as often as possible, even if it means only lubricating the rifle. The rifle should always be well lubricated, including the bore, except when actually firing. Before firing, always run a dry patch through the bore, if possible.

Jungle Operations (High Humidity). In hot and humid temperatures, keep the rifle lubricated and cased when not in use. Protect the rifle from rain and moisture whenever possible. Keep ammunition clean and dry. Clean the rifle, the bore, and the chamber daily. Keep the caps on the telescope when not in use. If moisture or fungus develops on the inside of the telescope, replace it. Clean and dry the stock daily. Dry the carrying case and rifle in the sun whenever possible.

Desert Operations. Keep the rifle dry and free of CLP and grease except on the rear of the bolt lugs. Keep the rifle free of sand by using the carrying sleeve or carrying case when not in use. Protect the rifle by using a wrap. Slide the wrap between the stock and barrel, then cross over on top of the scope. Next, cross under the rifle (over the magazine) and secure it. The rifle can still be placed into immediate operation but all critical parts are covered. The sealed hard case is preferred in the desert if the situation permits. Keep the telescope protected from the direct rays of the sun. Keep ammunition clean and protected from the direct rays of the sun. Use a toothbrush to remove sand from the bolt and receiver. Clean the bore and chamber daily. Protect the muzzle and receiver from blowing sand by covering with a clean cloth. To protect the free-floating barrel of the rifle, take an 8- or 9-inch strip of cloth and tie a knot in each end. Before going on a mission, slide the cloth between the barrel and stock all the way to the receiver and leave it there. When in position, slide the cloth out, taking all restrictive debris and sand with it.

Scope

The sniper has two sighting devices: the scope and iron sights. The scope allows the sniper to see the cross hairs and the image of the target with identical sharpness. It can be easily removed and replaced with less than 1/2 minute of angle change in zero. However, the scope should be left on the rifle. Iron sights are used only as a backup sighting system and can be quickly installed. The scope that will be used for this document is the M3A scope, so some factors might have to be adjusted for snipers who use other scopes.

The M3A scope is an optical instrument that the sniper uses to improve his ability to see his target clearly in most situations. Usually, the M3A scope presents the target at an increased size (as governed by scope magnification), relative to the same target at the same distance without a scope. The M3A scope helps the sniper to identify recognize the target. His increased sighting ability also helps him to successfully engage the target.

NOTE: The adjustment dials are under the adjustment dust cover.

a. M3A Scope Adjustments. The sniper must use the following adjustment procedures on the M3A scope:

(1) Focus adjustment dial. The focus adjustment dial (Figure 2-18) is on the left side of the scope barrel. This dial has limiting stops with the two extreme positions shown by the infinity mark and the largest dot. The focus adjustment dial keeps the target in focus. If the target is close, the dial is set at a position near the largest dot.

NOTE: Each minute of angle is an angular unit of measure.

(2) Elevation adjustment dial. The elevation adjustment dial (Figure 2-18) is on top of the scope barrel. This dial has calibrated index markings from 1 to 10. These markings represent the elevation setting adjustments needed at varying distances: 1 = 100 meters, 3 = 300 meters, 7 = 700 meters, and so on. Each click of the elevation dial equals 1 minute of angle.

(3) Windage adjustment dial. The windage adjustment dial (Figure 2-18) is on the right side of the scope barrel. This dial is used to make lateral adjustments to the scope. Turning the dial in the indicated direction moves the point of impact in that direction. Each click on the windage dial equals .5 minute of angle.

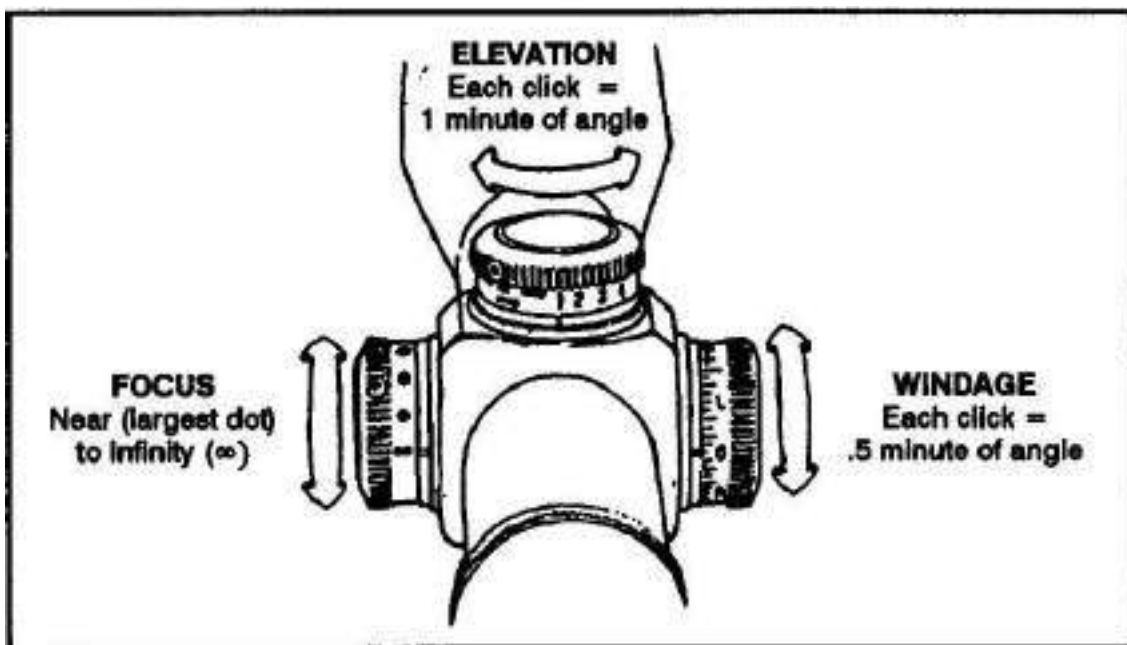

Figure 2-18. Focus, elevation, and windage adjustment dials.

(4) Eyepiece adjustment. The eyepiece (Figure 2-19) is adjusted by turning it in or out of the barrel until the reticle appears crisp and clear. Focusing the eyepiece should be done

after mounting the scope. The sniper grasps the eyepiece and backs it away from the lock ring. He does not attempt to loosen the lock ring first; it loosens automatically when he backs away from the eyepiece (no tools needed). The eyepiece is turned several turns to move it at least 1/8 inch. It takes this much change to achieve any measurable effect on the focus. The sniper looks through the scope at the sky or a blank wall and checks to see if the reticle appears sharp and crisp. He locks the lock ring after achieving reticle clarity.

WARNINGS

1. SECURELY FASTEN THE MOUNTING BASE TO THE RIFLE. LOOSE MOUNTING MAY CAUSE THE M3A SCOPE AND BASE MOUNT ASSEMBLY TO COME OFF THE RIFLE WHEN FIRING, POSSIBLY INJURING THE FIRER.
2. DURING RECOIL PREVENT THE M3A SCOPE FROM STRIKING THE FACE BY MAINTAINING AN AVERAGE DISTANCE OF 2 TO 3 INCHES BETWEEN THE EYE AND THE SCOPE.

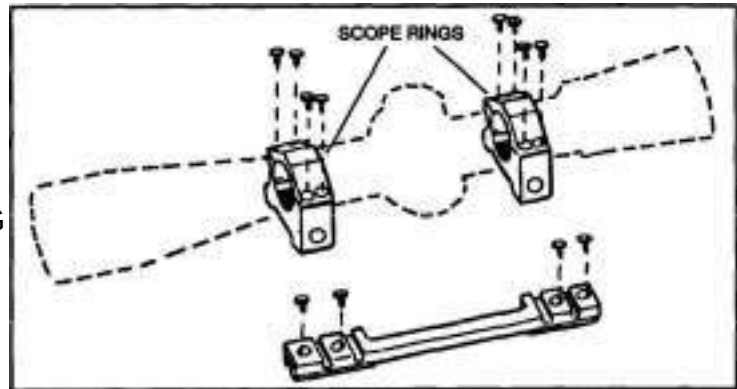

Figure 2-20. Scope mount.

M3A Scope Mount. The M3A scope mount has a baseplate with four screws; a pair of scope rings with eight ring screws, each with an upper and lower ring half with eight ring screws and two ring mounting bolts with nuts (Figure 2-20). The baseplate is mounted to the rifle by screwing the four baseplate screws through the plate and into the top of the receiver. The screws must not protrude into the receiver and interrupt the functioning of the bolt. After the baseplate is mounted, the scope rings are mounted.

- (1) Before mounting the M3A scope, lubricate the threads of each mounting ring nut.
- (2) Ensure smooth movement of each mounting ring nut and mount claw.
- (3) Inspect for burrs and foreign matter between each mounting ring nut and mount claw. Remove burrs or foreign matter before mounting.
- (4) Mount the sight and rings to the base.

NOTE: Once a set of slots is chosen, the same set should always be used in order for the SWS to retain zero.

- (5) Ensure the mounting surface is free of dirt, oil, or grease.
- (6) Set each ring bolt spline into the selected slot.
- (7) Slide the rear mount claw against the base and finger-tighten the mounting ring nut.
- (8) If the scope needs to be adjusted loosen the mounting ring nuts and align the ring bolts with the other set of slots on the base Repeat this process.
- (9) Slide the front mount claw against the base, and finger-tighten the mounting ring nut.
- (10) Use the T-handle torque wrench, which is preset to 65inch-pounds, to tighten the rear mounting ring nut.

c. Care and Maintenance of the M3A Scope. Dirt, rough handling, or abuse of optical equipment will result in inaccuracy and malfunction. When not in use, the rifle and scope should be cased, and the lens should be capped.

(1) Lens. The lens are coated with a special magnesium fluoride reflection-reducing material. This coat is thin and great care is required to prevent damage to it.

(a) To remove dust, lint, or other foreign matter from the lens, lightly brush the lens with a clean camel's-hair brush.

(b) To remove oil or grease from the optical surfaces, apply a drop of lens cleaning fluid or robbing alcohol on a lens tissue. Carefully wipe off the surface of the lens in circular motions (from the center to the outside edge). Dry off the lens with a clean lens tissue. In the field, if the proper supplies are not available, breathe heavily on the glass and wipe with a soft, clean cloth.

(2) Scope. The scope is a delicate instrument and must be handled with care. The following precautions will prevent damage

(a) Check and tighten all mounting screws periodically and always before an operation. Be careful not to change the coarse windage adjustment.

(b) Keep the lens free from oil and grease and never touch them with the fingers. Body grease and perspiration can injure them. Keep the cap on the lens.

(c) Do not force the elevation and windage screws or knobs.

(d) Do not allow the scope to remain in direct sunlight, and avoid letting the sun's rays shine through the lens. The lens magnify and concentrate sunlight into a pinpoint of intense heat, which is focused on the mil-scale reticle. This may melt the mil dots and damage the scope internally. Keep the lens covered and the entire scope covered when not in use.

(e) Avoid dropping the scope or striking it with another object. This could permanently damage the telescope as well as change the zero.

(f) To avoid damage to the scope or any other piece of sniper equipment, snipers or armorers should be the only personnel handling the equipment. Anyone who does not know how to use this equipment could cause damage.

(3) Climate conditions. Climate conditions play an important part in taking care of optical equipment.

(a) Cold climates. In extreme cold, care must be taken to avoid condensation and congealing of oil on the glass of the optical equipment. If the temperature is not excessive, condensation can be removed by placing the instrument in a warm place.

Concentrated heat must not be applied because it causes expansion and damage can occur. Moisture may also be blotted from the optics with lens tissue or a soft, dry cloth. In cold temperatures, oil thickens and causes sluggish operation or failure. Focusing parts are sensitive to freezing oils. Breathing forms frost, so the optical surfaces must be cleaned with lens tissue, preferably dampened lightly with alcohol. DO NOT apply alcohol on the glass of the optics.

(b) Jungle operations (high humidity). In hot and humid temperatures, keep the caps on the scope when not in use. If moisture or fungus develops on the inside of the telescope, replace it.

(c) Desert operations. Keep the scope protected from the direct rays. of the sun.

(d) Hot climate and salt water exposure. The scope is vulnerable to hot, humid climates and salt water atmosphere. It MUST NOT be exposed to direct sunlight. In humid and salt air conditions, the scope must be inspected, cleaned, and lightly oiled to avoid rust and corrosion. Perspiration can also cause the equipment to rust; therefore, the instruments must be thoroughly dried and lightly oiled.

M3A Scope Operation. When using the M3A scope, the sniper looks at the target and determines the distance to it by using the mil dots on the reticle. The mil-dot reticle (Figure 2-21) is a duplex-style reticle that has thick outer sections and thin inner sections. Superimposed on the thin center section of the reticle is a series of dots. There are 4 dots on each side of the center and 4 dots above and below the center. These 4 dots are spaced 1 mil apart, and 1 mil from both the center and the start of the thick section of the reticle. This spacing allows the sniper to make close estimates of target range, assuming there is an object of known size (estimate) in the field of view. For example, a human target appears to be 6 feet tall, which equals 1.83 meters tall, and at 500 meters, 3.65 dots high (nominally, about 3.5 dots high). Another example is a 1-meter target at a 1,000-meter range. This target is the height between 2 dots, or the width between 2 dots. If the sniper is given a good estimate of the object's size, then he may accurately determine target range using the mil-dot system.

Zeroing. Zeroing the M3A scope should be done on a known distance range (preferably 900 meters long) with bull's-eye-type targets (200-yard targets). When zeroing the scope, the sniper—

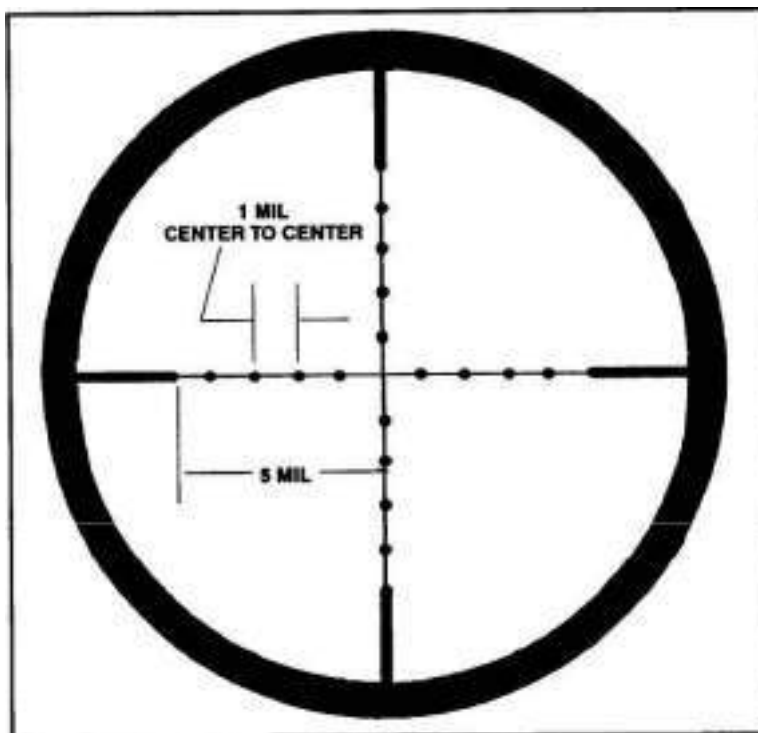

Figure 2-21. Mil-dot reticle.

(1) Assumes a good prone-supported position 100 meters from the target.

(2) Ensures the "I" on the elevation dial is lined up with the elevation index line, and

the "0" on the windage dial is lined up with the windage index line.

(3) Fires three rounds at the center of the target, keeping the same aiming point each time and triangulate.

(4) After the strike of the rounds has been noted, turns the elevation and windage dials to make the needed adjustments to the scope. Each click on the elevation dial equals one minute of angle. One minute of angle at 100 meters equals 1.145 inches or about 1 inch. Each click on the windage dial equals .5 minute of angle. .5 minute of angle at 100 meters equals about .5 inch.

(5) Repeats steps 3 and 4 until a three-round shot group is centered on the target.

(6) Once the shot group is centered, loosens the hex head screws on the elevation and windage dials. He turns the elevation dial to the index line marked "I" (if needed). He turns the windage dial to the index line marked "0" (if needed) and tightens the hex head screws.

(7) After zeroing at 100 meters and calibrating the dial, confirms this zero by firing and recording sight settings (see Chapter 3) at 100-meter increments through 900 meters.

Field-Expedient Confirmation/Zeroing. The sniper may need to confirm zero in a field environment. Examples are shortly after receiving a mission, a weapon was dropped, or excessive climatic changes as may be experienced by deploying to another part of the

world. Two techniques of achieving a crude zero are the 25-yard/900-inch method and the observation of impact method.

(1) 25-yard/900-inch method. Dial the scope to 300 meters for elevation and to "0" for windage. Aim and fire at a target that is at a 25-yard distance. Adjust the scope until rounds are impacting 5/8 of an inch above the point of aim. To confirm, set the elevation to 500 meters. The rounds should impact 2 1/4 inches above the point of aim.

(2) Observation of impact method. When a known distance range is unavailable, locate a target so that the observer can see the impact of rounds clearly. Determine the exact range to the target, dial in the appropriate range, and fire. Watch the impact of the rounds; the observer gives the sight adjustments until a point of aim or point of impact is achieved.

Other equipment

A observation telescope should also be used. The M49 observation telescope is a prismatic optical instrument of 20-power magnification. The telescope is focused by turning the eyepiece in or out until the image of the object being viewed is crisp and clear to the viewer. The sniper team carries the telescope on all missions. The observer uses the telescope to determine wind speed and direction by reading mirage, observing the bullet trace, and observing the bullet impact. The sniper uses this information to make quick and accurate adjustments for wind conditions. The lens are coated with a hard film of magnesium fluoride for maximum light transmission. Its high magnification makes observation, target detection, and target identification possible where conditions and range would otherwise preclude this ability. Camouflaged targets and those in deep shadows can be more readily distinguished. The team can observe troop movements at greater distances and identify selective targets with ease.

Binoculars are a must. The M19 is the preferred optical instrument for conducting hasty scans. This binocular has 7-power magnification with a 50-mm objective lens, and an interpupillary scale located on the hinge. The sniper should adjust the binocular until one sharp circle appears while looking through them. After adjusting the binoculars' interpupillary distance (distance between a person's pupils), the sniper should make a mental note of the reading on this scale for future reference. The eyepieces are also adjustable. The sniper can adjust one eyepiece at a time by turning the eyepiece with one hand while placing the palm of the other hand over the objective lens of the other monocular. While keeping both eyes open, he adjusts the eyepiece until he can see a crisp, clear view. After one eyepiece is adjusted, he repeats the procedure with the remaining eyepiece. The sniper should also make a mental note of the diopter scale reading on both eyepieces for future reference. One side of the binoculars has a laminated reticle pattern (Figure 2-32) that consists of a vertical and horizontal mil scale that is graduated in 10-mil increments. Using this reticle pattern aids the sniper in determining range and adjusting indirect-fires. The sniper uses the binoculars for—

- Calling for and adjusting indirect fires.
- Observing target areas.
- Observing enemy movement and positions.
- Identifying aircraft.
- Improving low-light level viewing.
- Estimating range.

Other equipment the sniper needs to complete a successful mission follows:

- a. Sidearms. Each member of the team should have a sidearm, such as a handgun. A sidearm gives a sniper the needed protection from a nearby threat while on the ground moving or while in the confines of a sniper position.
- b. Compass. Each member of the sniper team must have a lensatic compass for land navigation.
- c. Maps. The team must have military maps of their area of operations.
- d. Calculator. The sniper team needs a pocket-size calculator to figure distances when using the mil-relation formula. Solar-powered calculators usually work well, but under low-light conditions, battery power may be preferred. If a battery-powered calculator is to be used in low-light conditions, it should have a lighted display.
- e. Rucksack. The sniper's rucksack should contain at least a two-quart canteen, an entrenching tool, a first-aid kit, pruning shears, a sewing kit with canvas needles and nylon thread, spare netting and garnish, rations, and personal items as needed. The sniper also carries his ghillie suit in his rucksack until the mission requires its use.
- f. Measuring Tape. A standard 10-foot to 25-foot metal carpenter's tape allows the sniper to measure items in his operational area. This information is recorded in the sniper data book.
- g. Communication devices such as a laptop.

Marksmanship

Sniper marksmanship is an extension of basic rifle marksmanship and focuses on the techniques needed to engage targets at extended ranges. To successfully engage targets at increased distances, the sniper team must be proficient in marksmanship fundamentals and advanced marksmanship skills. Examples of these skills are determining the effects of weather conditions on ballistics, holding off for elevation and windage, engaging moving targets, using and adjusting scopes, and zeroing procedures. Marksmanship skills should be practiced often.

The sniper team must be thoroughly trained in the fundamentals of marksmanship. These include assuming a position, aiming, breath control, and trigger control. These fundamentals develop fixed and correct firing habits for instinctive application. Every sniper should periodically refamiliarize himself with these fundamentals regardless of his experience.

The sniper should assume a good firing position in order to engage targets with any consistency. A good position enables the sniper to relax and concentrate when preparing to fire.

- a. Position Elements. Establishing a mental checklist of steady position elements enhances the sniper's ability to achieve a first-round hit.
 - (1) Nonfiring hand. Use the nonfiring hand to support the butt of the weapon. Place the hand next to the cheek and rest the tip of the butt on it. Bail the hand into a fist to raise the weapon's butt or loosen the fist
 - (2) Butt of the stock. Place the butt of the stock firmly in the pocket of the shoulder. Insert a pad on the ghillie suit (see Chapter 4) where contact with the butt is made to reduce the effects of pulse beat and breathing, which can be transmitted to the weapon.
 - (3) Firing hand. With the firing hand, grip the small of the stock. Using the middle through little fingers, exert a slight rearward pull to keep the butt of the weapon firmly in the pocket of the shoulder. Place the thumb over the top of the small of the stock. Place the index finger on the trigger, ensuring it does not touch the stock of the weapon. This avoids disturbing the lay of the rifle when the trigger is squeezed.

- (4) Elbows. Find a comfortable position that provides the greatest support.
- (5) Stock weld. Place the cheek in the same place on the stock with each shot. A change in stock weld tends to cause poor sight alignment, reducing accuracy.
- (6) Bone support. Bone support is the foundation of the firing position; they provide steady support of the weapon.
- (7) Muscle relaxation. When using bone support, the sniper can relax muscles, reducing any movement that could be caused by tense or trembling muscles. Aside from tension in the trigger finger and firing hand, any use of the muscle generates movement of the sniper's cross hairs.
- (8) Natural point of aim. The point at which the rifle naturally rest in relation to the aiming point is called natural point of aim.

(a) Once the sniper is in position and aimed in on his target, the method for checking for natural point of aim is for the sniper to close his eyes, take a couple of breaths, and relax as much as possible. Upon opening his eyes, the scope's cross hairs should be positioned at the sniper's preferred aiming point. Since the rifle becomes an extension of the sniper's body, it is necessary to adjust the position of the body until the rifle points naturally at the preferred aiming point on the target.

(b) Once the natural point of aim has been determined, the sniper must maintain his position to the target. To maintain his natural point of aim in all shooting positions, the natural point of aim can be readjusted and checked periodically.

(c) The sniper can change the elevation of the natural point of aim by leaving his elbows in place and by sliding his body forward or rearward. This raises or lowers the muzzle of the weapon, respectively. To maintain the natural point of aim after the weapon has been fired, proper bolt operation becomes critical. The sniper must practice reloading while in the prone position without removing the butt of the weapon from the firing shoulder. This may be difficult for the left-hand firer. The two techniques for accomplishing this task are as follows:

- After firing, move the bolt slowly to the rear while canting the weapon to the right. Execution of this task causes the spent cartridge to fall next to the weapon.
- After firing, move the bolt to the rear with the thumb of the firing hand. Using the index and middle fingers, reach into the receiver and catch the spent cartridge as it is being ejected. This technique does not require canting the weapon.

NOTE: The sniper conducts bolt operation under a veil or equivalent camouflage to improve concealment.

b. Steady Firing Position. On the battlefield, the sniper must assume a steady firing position with maximum use of cover and concealment. Considering the variables of terrain, vegetation, and tactical situations, the sniper can use many variations of the basic positions. When assuming a firing position, he must adhere to the following basic rules:

- (1) Use any support available.
- (2) Avoid touching the support with the barrel of the weapon since it interferes with barrel harmonics and reduces accuracy.
- (3) Use a cushion between the weapon and the support to prevent slippage of the weapon.
- (4) Use the prone supported position whenever possible.

Sometimes, the prone, sitting, or kneeling positions will not be possible to be executed, and the sniper will have to stand. Standing supported position. The standing supported position is the least steady of the supported positions and should be used only as a last resort (Figure 3-6).

(a) To assume the standing supported position with horizontal support, such as a wall or ledge, the sniper proceeds as follows:

Locate a solid object for support. Avoid branches as they tend to sway when wind is present.

- Form a V with the thumb and forefinger of the nonfiring hand.
- Place the nonfiring hand against the support with the fore-end of the weapon resting in the V of the hand. This steadies the weapon and allows quick recovery from recoil.
- Then place the butt of the weapon in the pocket of the shoulder.

(b) To use vertical support (Figure 3-7), such as a tree, telephone pole, corner of building, or vehicle, the sniper proceeds as follows:

- Locate stable support. Face the target, then turn 45 degrees to the right of the target, and place the palm of the nonfiring hand at arm's length against the support. Lock the left arm straight, let the left leg buckle, and place body weight against the nonfiring hand. Keep the trail leg straight.
- Place the fore-end of the weapon in the V formed by extending the thumb of the nonfiring hand. Exert more pressure to the rear with the firing hand.



Figure 3-6. Standing supported position (horizontal support).



Figure 3-7. Standing supported position (vertical support).

(6) Hawkins position. The Hawkins position (Figure 3-8) is a variation of the prone unsupported position. The sniper uses it when firing from a low bank or a depression in the ground, over a roof, or so forth. It cannot be used on level ground since the muzzle cannot

be raised high enough to aim at the target. It is a low-profile position with excellent stability and aids concealment. To assume this position, the sniper uses the weapon's sling and proceeds as follows:

CAUTION: LOCK THE NONFIRING ARM STRAIGHT OR THE FACE WILL ABSORB THE WEAPON'S RECOIL.

- (a) After assuming a prone position, grasp the upper sling swivel and sling with the nonfiring hand, forming a fist to support the front of the weapon.
- (b) Ensure the nonfiring arm is locked straight since it will absorb the weapon's recoil. Wearing a glove is advisable.
- (c) Rest the butt of the weapon on the ground and place it under the firing shoulder. The sniper can make minor adjustments in muzzle elevation by tightening or relaxing the fist of the nonfiring hand. If more elevation is required, he can place a support under the nonfiring fist.

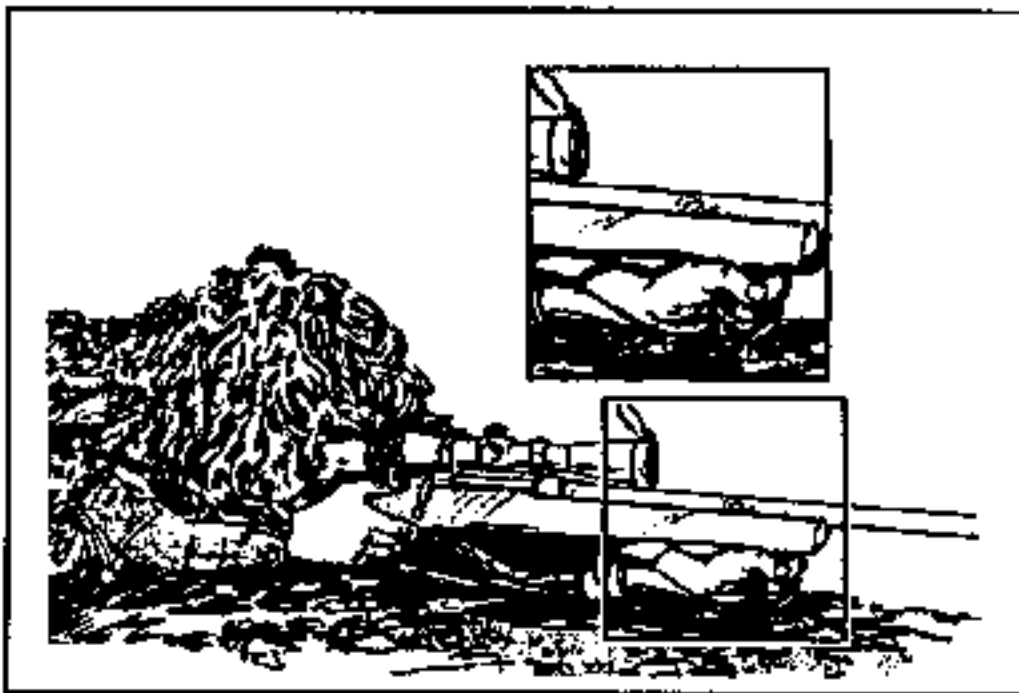

Figure 3-8. Hawkins position.

The sniper begins the aiming process by aligning the rifle with the target when assuming a firing position. He should point the rifle naturally at the desired point of aim. If his muscles are used to adjust the weapon onto the point of aim, they automatically relax as the rifle fires, and the rifle begins to move toward its natural point of aim. Because this movement begins just before the weapon discharge, the rifle is moving as the bullet leaves the muzzle. This causes inaccurate shots with no apparent cause (recoil disguises the movement). By adjusting the weapon and body as a single unit, rechecking, and readjusting as needed, the sniper achieves a true natural point of aim. Once the position is established, the sniper then aims the weapon at the exact point on the target. Aiming involves: eye relief, sight alignment, and sight picture.

a. Eye Relief. This is the distance from the sniper's firing eye to the rear sight or the rear of the scope tube. When using iron sights, the sniper ensures the distance remains consistent from shot to shot to preclude changing what he views through the rear sight. However, relief will vary from firing position to firing position and from sniper to sniper, according to the sniper's neck length, his angle of head approach to the stock, the depth of his shoulder pocket, and his firing position. This distance is more rigidly controlled with telescopic sights than with iron sights. The sniper must take care to prevent eye injury caused by the scope tube striking his brow during recoil. Regardless of the sighting system he uses, he must place his head as upright as possible with his firing eye located directly behind the rear portion of the sighting system. This head placement also allows the muscles surrounding his eye to relax. Incorrect head placement causes the sniper to look out of the top or corner of his eye, resulting in muscular strain. Such strain leads to blurred vision and can also cause eye strain. The sniper can avoid eye strain by not staring through the telescopic or iron sights for extended periods. The best aid to consistent eye relief is maintaining the same stock weld from shot to shot.

b. Sight Alignment. With telescopic sights, sight alignment is the relationship between the cross hairs (reticle) and a full field of view as seen by the sniper. The sniper must place his head so that a full field of view fills the tube, with no dark shadows or crescents to cause inaccurate shots. He centers the reticle in a full field of view, ensuring the vertical cross hair is straight up and down so the rifle is not canted. Again, the center is easiest for the sniper to locate and allows for consistent reticle placement. With iron sights, sight alignment is the relationship between the front and rear sights as seen by the sniper (Figure 3-17). The sniper centers the top edge of the front sight blade horizontally and vertically within the rear aperture. (The center of aperture is easiest for the eye to locate and allows the sniper to be consistent in blade location.)

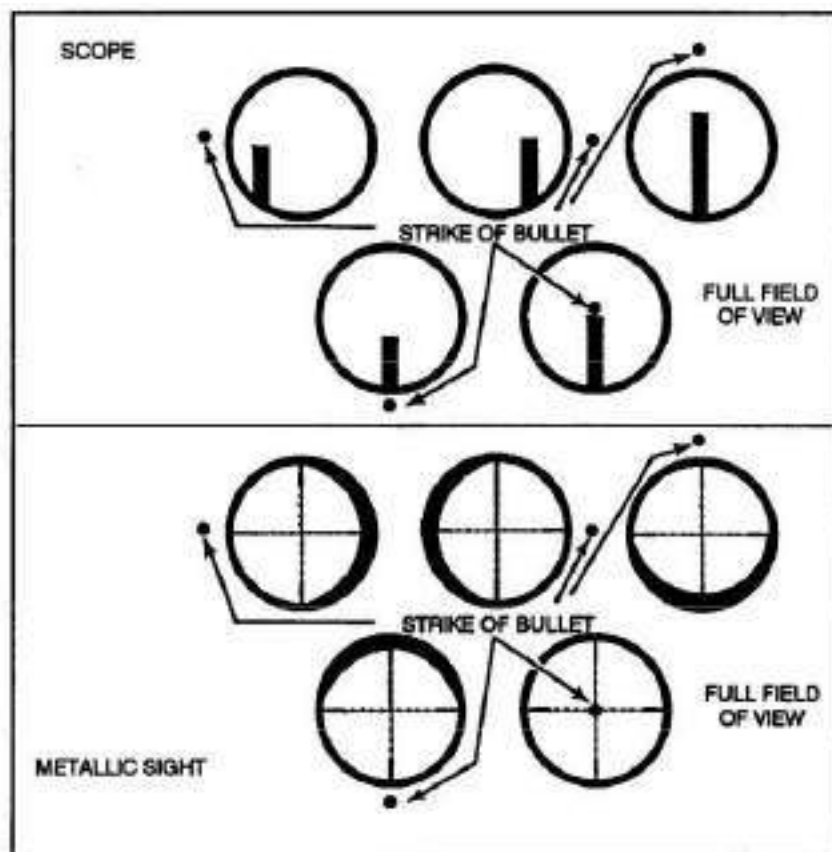

Figure 3-17. Sight alignment.

c. Sight Picture. With telescopic sights, the sight picture is the relationship between the reticle and full field of view and the target as seen by the sniper. The sniper centers the reticle in a full field of view. He then places the reticle center of the largest visible mass of the target (as in iron sights). The center of mass of the target is easiest for the sniper to locate, and it surrounds the intended point of impact with a maximum amount of target area. With iron sights, sight picture is the relationship between the rear aperture, the front sight blade, and the target as seen by the sniper (Figure 3-18). The sniper centers the top edge of the blade in the rear aperture. He then places the top edge of the blade in the center of the largest visible mass of the target (disregard the head and use the center of the torso).

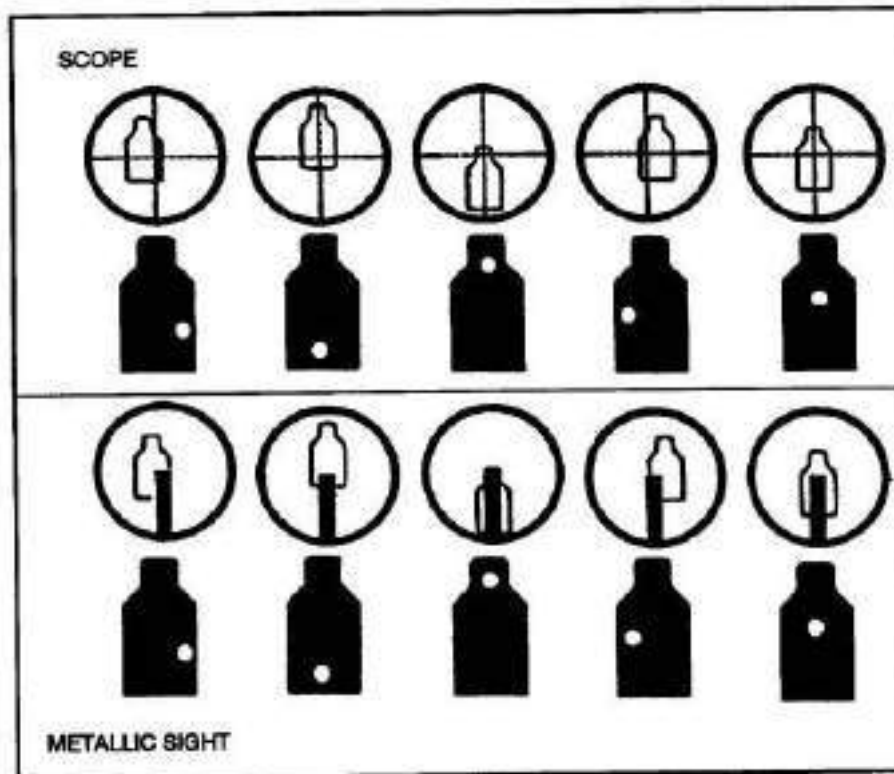

Figure 3-18. Sight picture.

d. Sight Alignment Error. When sight alignment and picture are perfect (regardless of sighting system) and all else is done correctly, the shot will hit center of mass on the target. However, with an error in sight alignment, the bullet is displaced in the direction of the error. Such an error creates an angular displacement between the line of sight and the line of bore. This displacement increases as range increases; the amount of bullet displacement depends on the size of alignment error. Close targets show little or no visible error. Distant targets can show great displacement or can be missed altogether due to severe sight misalignment. An inexperienced sniper is prone to this kind of error, since he is unsure of what correctly aligned sights look like (especially telescopic sights); a sniper varies his head position (and eye relief) from shot to shot, and he is apt to make mistakes while firing.

e. Sight Picture Error. An error in sight picture is an error in the placement of the aiming point. This causes no displacement between the line of sight and the line of bore. The weapon is simply pointed at the wrong spot on the target. Because no displacement exists

as range increases, close and far targets are hit or missed depending on where the front sight or the reticle is when the rifle fires. All snipers face this kind of error every time they shoot. This is because, regardless of firing position stability, the weapon will always be moving. A supported rifle moves much less than an unsupported one, but both still move in what is known as a wobble area. The sniper must adjust his firing position so that his wobble area is as small as possible and centered on the target. With proper adjustments, the sniper should be able to fire the shot while the front sight blade or reticle is on the target at, or very near, the desired aiming point. How far the blade or reticle is from this point when the weapon fires is the amount of sight picture error all snipers face.

f. Dominant Eye. To determine which eye is dominant, the sniper extends one arm to the front and points the index finger skyward to select an aiming point. With both eyes open, he aligns the index finger with the aiming point, then closes one eye at a time while looking at the aiming point. One eye will make the finger appear to move off the aiming point; the other eye will stay on the aiming point. The dominant eye is the eye that does not move the finger from the aiming point. Some individuals may have difficulty aiming because of interference from their dominant eye, if this is not the eye used in the aiming process. This may require the sniper to fire from the other side of the weapon (right-handed firer will fire left-handed). Such individuals must close the dominant eye while shooting.

Breath control is important with respect to the aiming process. If the sniper breathes while trying to aim, the rise and fall of his chest causes the rifle to move. He must, therefore, accomplish sight alignment during breathing. To do this, he first inhales then exhales normally and stops at the moment of natural respiratory pause.

a. A respiratory cycle lasts 4 to 5 seconds. Inhalation and exhalation require only about 2 seconds. Thus, between each respiratory cycle there is a pause of 2 to 3 seconds. This pause can be extended to 10 seconds without any special effort or unpleasant sensations. The sniper should shoot during this pause when his breathing muscles relax. This avoids strain on his diaphragm.

b. A sniper should assume his firing position and breathe naturally until his hold begins to settle. Many snipers then take a slightly deeper breath, exhale, and pause, expecting to fire the shot during the pause. If the hold does not settle enough to allow the shot to be fired, the sniper resumes normal breathing and repeats the process.

c. The respiratory pause should never feel unnatural. If it is too long, the body suffers from oxygen deficiency and sends out signals to resume breathing. These signals produce involuntary movements in the diaphragm and interfere with the sniper's ability to concentrate. About 8 to 10 seconds is the maximum safe period for the respiratory pause. During multiple, rapid engagements, the breathing cycle should be forced through a rapid, shallow cycle between shots instead of trying to hold the breath or breathing. Firing should be accomplished at the forced respiratory pause.

Trigger control is the most important of the sniper marksmanship fundamentals. It is defined as causing the rifle to fire when the sight picture is at its best, without causing the rifle to move. Trigger squeeze is uniformly increasing pressure straight to the rear until the rifle fires.

a. Proper trigger control occurs when the sniper places his firing finger as low on the trigger as possible and still clears the trigger guard, thereby achieving maximum mechanical advantage and movement of the finger to the entire rifle.

b. The sniper maintains trigger control beat by assuming a stable position, adjusting on the target, and beginning a breathing cycle. As the sniper exhales the final breath toward a natural respiratory pause, he secures his finger on the trigger. As the front blade or reticle settles at the desired point of aim, and the natural respiratory pause is entered, the sniper applies initial pressure. He increases the tension on the trigger during the respiratory pause as long as the front blade or reticle remains in the area of the target that ensures a well-placed shot. If the front blade or reticle moves away from the desired point of aim on the target, and the pause is free of strain or tension, the sniper stops increasing the tension on the trigger, waits for the front blade or reticle to return to the desired point, and then continues to squeeze the trigger. If movement is too large for recovery or if the pause has become uncomfortable (extended too long), the sniper should carefully release the pressure on the trigger and begin the respiratory cycle again.

c. As the stability of a firing position decreases, the wobble area increases. The larger the wobble area, the harder it is to fire the shot without reacting to it. This reaction occurs when the sniper—

(1) Anticipates recoil. The firing shoulder begins to move forward just before the round fires.

(2) Jerks the trigger. The trigger finger moves the trigger in a quick, choppy, spasmodic attempt to fire the shot before the front blade or reticle can move away from the desired point of aim.

(3) Flinches. The sniper's entire upper body (or parts thereof) overreacts to anticipated noise or recoil. This is usually due to unfamiliarity with the weapon.

(4) Avoids recoil. The sniper tries to avoid recoil or noise by moving away from the weapon or by closing the firing eye just before the round fires. This, again, is caused by a lack of knowledge of the weapon's actions upon firing.

Applying the fundamentals increases the odds of a well-aimed shot being fired. When mastered, additional skills can make that first-round kill even more of a certainty. One of these skills is the follow-through.

a. Follow-through is the act of continuing to apply all the sniper marksmanship fundamentals as the weapon fires as well as immediately after it fires. It consists of—

(1) Keeping the head in firm contact with the stock (stock weld).

(2) Keeping the finger on the trigger all the way to the rear.

(3) Continuing to look through the rear aperture or scope tube.

(4) Keeping muscles relaxed.

(5) Avoiding reaction to recoil and or noise.

(6) Releasing the trigger only after the recoil has stopped.

b. A good follow-through ensures the weapon is allowed to fire and recoil naturally. The sniper/rifle combination reacts as a single unit to such actions.

Calling the shot is being able to tell where the round should impact on the target. Because live targets invariably move when hit, the sniper will find it almost impossible to use his scope to locate the target after the round is fired. Using iron sights, the sniper will find that

searching for a downrange hit is beyond his abilities. He must be able to accurately call his shots. Proper follow-through will aid in calling the shot. The dominant factor in shot calling is knowing where the reticle or blade is located when the weapon discharges. This location is called the final focus point.

a. With iron sights, the final focus point should be on the top edge of the front sight blade. The blade is the only part of the sight picture that is moving (in the wobble area). Focusing on it aids in calling the shot and detecting any errors in sight alignment or sight picture. Of course, lining up the sights and the target initially requires the sniper to shift his focus from the target to the blade and back until he is satisfied that he is properly aligned with the target. This shifting exposes two more facts about eye focus. The eye can instantly shift focus from near objects (the blade) to far objects (the target).

b. The final focus is easily placed with telescopic sights because of the sight's optical qualities. Properly focused, a scope should present both the field of view and the reticle in sharp detail. Final focus should then be on the target. While focusing on the target, the sniper moves his head slightly from side to side. The reticle may seem to move across the target face, even though the rifle and scope are motionless. This movement is parallax. Parallax is present when the target image is not correctly focused on the reticle's focal plane. Therefore, the target image and the reticle appear to be in two separate positions inside the scope, causing the effect of reticle movement across the target. The M3A scope on the rifle has a focus adjustment that eliminates parallax in the scope. The sniper should adjust the focus knob until the target's image is on the same focal plane as the reticle. To determine if the target's image appears at the ideal location, the sniper should move his head slightly left and right to see if the reticle appears to move. If it does not move, the focus is properly adjusted and no parallax will be present.

Once the sniper has been taught the fundamentals of marksmanship, his primary concern is his ability to apply it in the performance of his mission. An effective method of applying fundamentals is through the use of the integrated act of firing one round. The integrated act is a logical, step-by-step development of fundamentals whereby the sniper can develop habits that enable him to fire each shot the same way. The integrated act of firing can be divided into four distinct phases:

a. Preparation Phase. Before departing the preparation area, the sniper ensures that—

- (1) The team is mentally conditioned and knows what mission they are to accomplish.
- (2) A systematic check is made of equipment for completeness and serviceability including, but not limited to—
 - (a) Properly cleaned and lubricated rifles.
 - (b) Properly mounted and torqued scopes.
 - (c) Zero-sighted systems and recorded data in the sniper data book.
 - (d) Study of the weather conditions to determine their possible effects on the team's performance of the mission.

b. Before-Firing Phase. On arrival at the mission site, the team exercises care in selecting positions. The sniper ensures the selected positions support the mission. During this phase, the sniper—

- (1) Maintains strict adherence to the fundamentals of position. He ensures that the firing position is as relaxed as possible, making the most of available external support. He also makes sure the support is stable, conforms to the position, and allows a correct, natural point of aim for each designated area or target.

- (2) Once in position, removes the scope covers and checks the field(s) of fire, making any needed corrections to ensure clear, unobstructed firing lanes.
- (3) Makes dry firing and natural point of aim checks.
- (4) Double-checks ammunition for serviceability and completes final magazine loading.
- (5) Notifies the observer he is ready to engage targets. The observer must be constantly aware of weather conditions that may affect the accuracy of the shots. He must also stay ahead of the tactical situation.

c. Firing Phase. Upon detection, or if directed to a suitable target, the sniper makes appropriate sight changes, aims, and tells the observer he is ready to fire. The observer then gives the needed windage and observes the target. To fire the rifle, the sniper should remember the keyword, "BRASS." Each letter is explained as follows:

- (1) Breathe. The sniper inhales and exhales to the natural respiratory pause. He checks for consistent head placement and stock weld. He ensures eye relief is correct (full field of view through the scope; no shadows present). At the same time, he begins aligning the cross hairs or front blade with the target at the desired point of aim.
- (2) Relax. As the sniper exhales, he relaxes as many muscles as possible, while maintaining control of the weapon and position.
- (3) Aim. If the sniper has a good, natural point of aim, the rifle points at the desired target during the respiratory pause. If the aim is off, the sniper should make a slight adjustment to acquire the desired point of aim. He avoids "muscling" the weapon toward the aiming point.
- (4) Squeeze. As long as the sight picture is satisfactory, the sniper squeezes the trigger. The pressure applied to the trigger must be straight to the rear without disturbing the lay of the rifle or the desired point of aim.

d. After-Firing Phase. The sniper must analyze his performance. If the shot impacted at the desired spot (a target hit), it may be assumed the integrated act of firing one round was correctly followed. If however, the shot was off call, the sniper and observer must check for Possible errors.

- (1) Failure to follow the keyword, BRASS (partial field of view, breath held incorrectly, trigger jerked, rifle muscled into position, and so on).
- (2) Target improperly ranged with scope (causing high or low shots).
- (3) Incorrectly compensated for wind (causing right or left shots).
- (4) Possible weapon/ammunition malfunction (used only as a last resort when no other errors are detected). Once the probable reasons for an off-call shot is determined the sniper must make note of the errors. He pays close attention to the problem areas to increase the accuracy of future shots.

Engaging moving targets not only requires the sniper to determine the target distance and wind effects on the round, but he must also consider the lateral and speed angle of the target, the round's time of flight, and the placement of a proper lead to compensate for both. These added variables increase the chance of a miss. Therefore, the sniper should engage moving targets when it is the only option.

To engage moving targets, the sniper employs the following techniques:

- Leading.
- Tracking.

- Trapping or ambushing.
- Tracking and holding.
- Firing a snap shot.

a. Leading. Engaging moving targets requires the sniper to place the cross hairs ahead of the target's movement. The distance the cross hairs are placed in front of the target's movement is called a lead. There are four factors in determining leads:

(1) Speed of the target. As a target moves faster, it will move a greater distance during the bullet's flight. Therefore, the lead increases as the target's speed increases.

(2) Angle of movement. A target moving perpendicular to the bullet's flight path moves a greater lateral distance than a target moving at an angle away from or toward the bullet's path. Therefore, a target moving at a 45-degree angle covers less ground than a target moving at a 90-degree angle.

(3) Range to the target. The farther away a target is, the longer it takes for the bullet to reach it. Therefore, the lead must be increased as the distance to the target increases.

(4) Wind effects. The sniper must consider how the wind will affect the trajectory of the round. A wind blowing against the target's direction of movement requires less of a lead than a wind blowing in the same direction as the target's movement.

b. Tracking. Tracking requires the sniper to establish an aiming point ahead of the target's movement and to maintain it as the weapon is fired. This requires the weapon and body position to be moved while following the target and firing.

c. Trapping or Ambushing. Trapping or ambushing is the sniper's preferred method of engaging moving targets. The sniper must establish an aiming point ahead of the target and pull the trigger when the target reaches it. This method allows the sniper's weapon and body position to remain motionless. With practice, a sniper can determine exact leads and aiming points using the horizontal stadia lines in the mil dots in the M3A.

d. Tracking and Holding. The sniper uses this technique to engage an erratically moving target. That is, while the target is moving, the sniper keeps his cross hairs centered as much as possible and adjusts his position with the target. When the target stops, the sniper quickly perfects his hold and fires. This technique requires concentration and discipline to keep from firing before the target comes to a complete halt.

e. Firing a Snap Shot. A sniper may often attempt to engage a target that only presents itself briefly, then resumes cover. Once he establishes a pattern, he can aim in the vicinity of the target's expected appearance and fire a snap shot at the moment of exposure.

When engaging moving targets, the sniper makes common errors because he is under greater stress than with a stationary target. There are more considerations, such as retaining a steady position and the correct aiming point, how fast the target is moving, and how far away it is. The more practice a sniper has shooting moving targets, the better he will become. Some common mistakes are as follows:

a. The sniper has a tendency to watch his target instead of his aiming point. He must force himself to watch his lead point.

b. The sniper may jerk or flinch at the moment his weapon fires because he thinks he must fire NOW. This can be overcome through practice on a live-fire range.

c. The sniper may hurry and thus forget to apply wind as needed. Windage must be calculated for moving targets just as for stationary targets. Failure to do this when squiring a lead will result in a miss.

Once the required lead has been determined, the sniper should use the mil scale in the scope for precise holdoff. The mil scale can be mentally sectioned into 1/4-mil increments for leads. The chosen point on the mil scale becomes the sniper's point of concentration just as the cross hairs are for stationary targets. The sniper concentrates on the lead point and fires the weapon when the target is at this point. The following formulas are used to determine moving target leads:

TIME OF FLIGHT X TARGET SPEED = LEAD.

- Time of flight= flight time of the round in seconds.
- Target speed = speed the target is moving in feet per second.
- Lead = distance aiming point must be placed ahead of movement in feet.

Average speed of a man during—

- Slow patrol = 1 fps/0.8 mph
- Fast patrol = 2 fps/1.3 mph
- Slow walk = 4 fps/2.5 mph
- Fast walk = 6 fps/3.7 mph

To convert leads in feet to meters:
LEAD IN FEET X 0,3048 = METERS

To convert leads in meters to mils:

LEAD IN METERS X 1,000 = MIL LEAD
RANGE TO TARGET

Holdoff

Holdoff is shifting the point of aim to achieve a desired point of impact. Certain situations, such as multiple targets at varying ranges and rapidly changing winds, do not allow proper windage and elevation adjustments. Therefore, familiarization and practice of elevation and windage holdoff techniques prepare the sniper to meet these situations.

Elevation: This technique is used only when the sniper does not have time to change his sight setting. The sniper rarely achieves pinpoint accuracy when holding off, since a minor error in range determination or a lack of a precise aiming point might cause the bullet to miss the desired point. He uses holdoff with the sniperscope only if several targets appear at various ranges, and time does not permit adjusting the scope for each target.

a. The sniper uses holdoff to hit a target at ranges other than the range for which the rifle is presently adjusted. When the sniper aims directly at a target at ranges greater than the set range, his bullet will hit below the point of aim. At lesser ranges, his bullet will hit higher than the point of aim. If the sniper understands this and knows about trajectory and bullet drop, he will be able to hit the target at ranges other than that for which the rifle was adjusted. For example, the sniper adjusts the rifle for a target located 500 meters downrange and another target appears at a range of 600 meters. The holdoff would be 25

inches, that is, the sniper should hold off 25 inches above the center of visible mass in order to hit the center of mass of that particular target (Figure 3-24). If another target were to appear at 400 meters, the sniper would aim 14 inches below the ureter of visible mass in order to hit the center of mass (Figure 3-25).

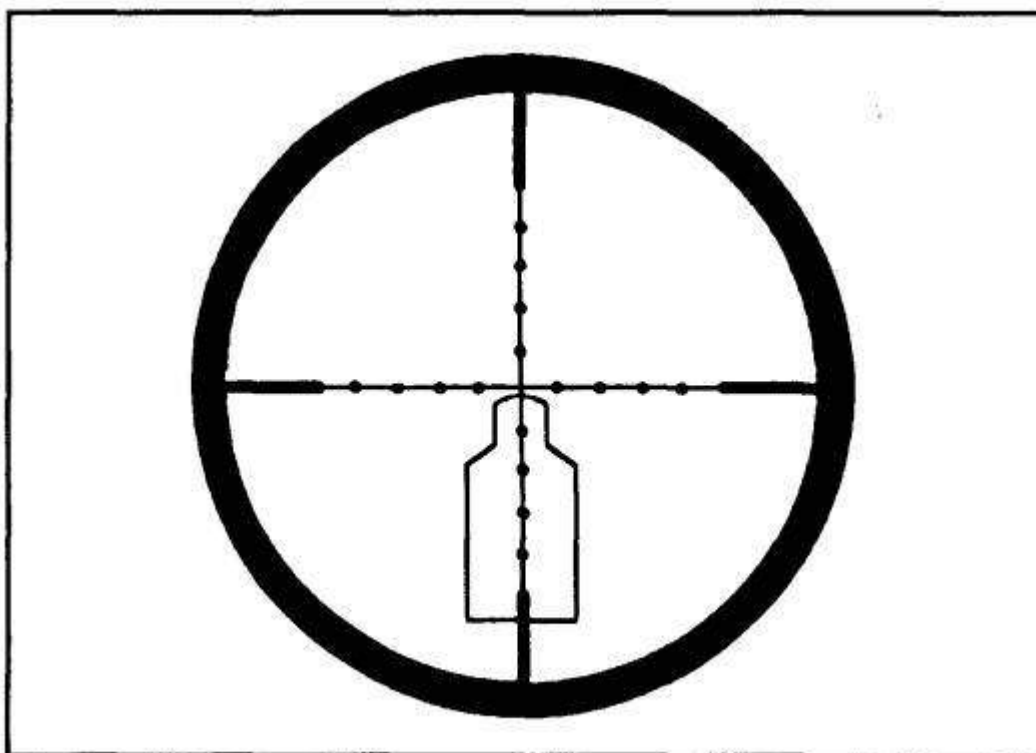

Figure 3-24. Elevation.

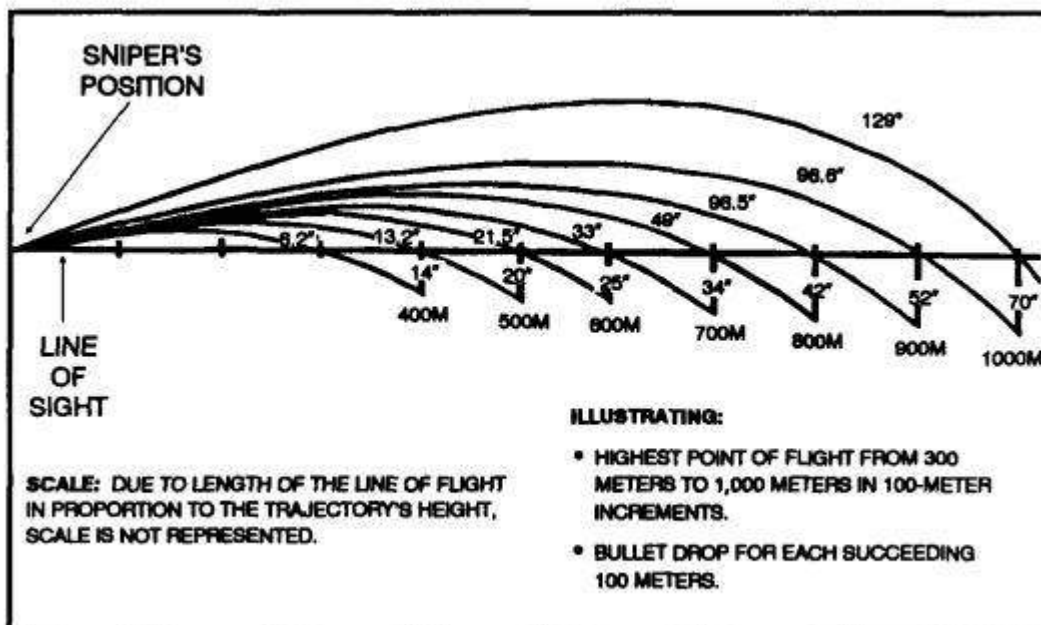

Figure 3-25. Trajectory chart.

This chart will vary depending on what rifle is used.

b. The vertical mil dots on the M3A scope's reticle can be used as aiming points when using elevation holdoffs. For example, if the sniper has to engage a target at 500 meters and the scope is set at 400 meters, he would place the first mil dot 5 inches below the vertical line on the target's center mass. This gives the sniper a 15-inch holdoff at 500 meters.

The sniper can use holdoff in three ways to compensate for the effect of wind.

a. When using the M3A scope, the sniper uses the horizontal mil dots on the reticle to hold off for wind. For example, if the sniper has a target at 500 meters that requires a 10-inch holdoff, he would place the target's center mass halfway between the cross hair and the first mil dot (1/2 mil) (Figure 3-26).

b. When holding off, the sniper aims into the wind. If the wind is moving from the right to left, his point of aim is to the right. If the wind is moving from left to right, his point of aim is to the left.

c. Constant practice in wind estimation can bring about proficiency in making sight adjustments or learning to apply holdoff correctly. If the sniper misses the target and the point of impact of the round is observed, he notes the lateral distance of his error and refires, holding off that distance in the opposite direction.

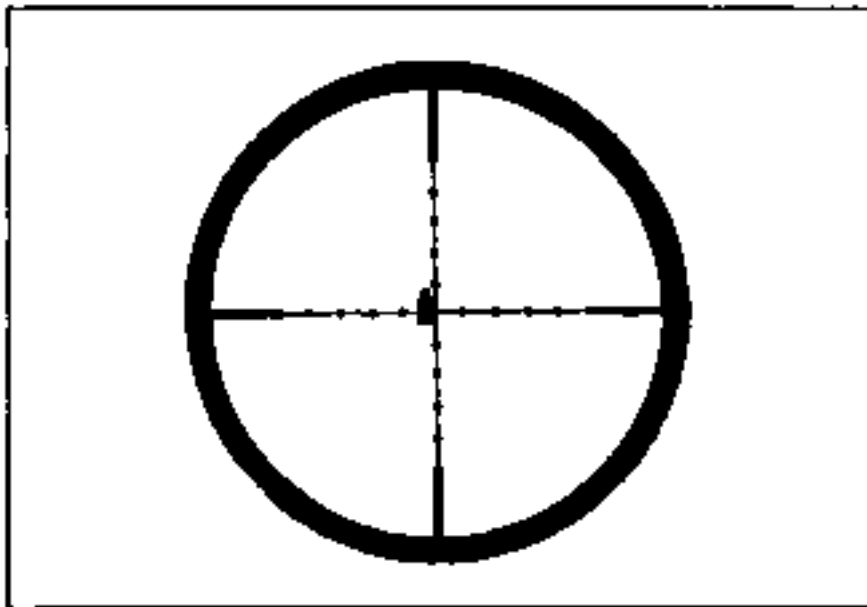

Figure 3-26. Holdoff for 7.62-mm special ball (M118).

Ballistics

As applied to sniper marksmanship, types of ballistics may be defined as the study of the firing, flight, and effect of ammunition. Proper execution of marksmanship fundamentals and a thorough knowledge of ballistics ensure the successful completion of the mission. Tables and formulas in this section should be used only as guidelines since every rifle performs differently. Maximum ballistics data eventually result in a well-kept sniper data book and knowledge gained through experience.

Ballistics are divided into three distinct types: internal external, and terminal.

a. Internal: the interior workings of a weapon and the functioning of its ammunition.

- b. External: the flight of the bullet from the muzzle to the target.
- c. Terminal: what happens to the bullet after it hits the target.

To fully understand ballistics, the sniper should be familiar with the following terms:

- a. Muzzle Velocity—the speed of the bullet as it leaves the rifle barrel, measured in feet per second. It varies according to various factors, such as ammunition type and lot number, temperature, and humidity.
- b. Line of Sight—straight line from the eye through the aiming device to the point of aim.
- c. Line of Departure—the line defined by the bore of the rifle or the path the bullet would take without gravity.
- d. Trajectory—the path of the bullet as it travels to the target.
- e. Midrange Trajectory/Maximum Ordinate—the highest point the bullet reaches on its way to the target. This point must be known to engage a target that requires firing underneath an overhead obstacle, such as a bridge or a tree. Inattention to midrange trajectory may cause the sniper to hit the obstacle instead of the target.
- f. Bullet Drop—how far the bullet drops from the line of departure to the point of impact.
- g. Time of Flight—the amount of time it takes for the bullet to reach the target from the time the round exits the rifle.
- h. Retained Velocity—the speed of the bullet when it reaches the target. Due to drag, the velocity will be reduced.

To be effective, the sniper must know marksmanship fundamentals and what effect gravity and drag will have on those fundamentals.

- a. Gravity. As soon as the bullet exits the muzzle of the weapon, gravity begins to pull it down, requiring the sniper to use his elevation adjustment. At extended ranges, the sniper actually aims the muzzle of his rifle above his line of sight and lets gravity pull the bullet down into the target. Gravity is always present, and the sniper must compensate for this through elevation adjustments or hold-off techniques.
- b. Drag. Drag is the slowing effect the atmosphere has on the bullet. This effect decreases the speed of the bullet according to the air—that is, the less dense the air, the less drag and vice versa. Factors affecting drag/density are temperature, altitude/barometric pressure, humidity, efficiency of the bullet, and wind.
 - (1) Temperature. The higher the temperature, the less dense the air. (See Section III.) If the sniper zeros at 60 °F and he fires at 80 degrees, the air is less dense, thereby causing an increase in muzzle velocity and higher point of impact. A 20-degree change equals a one-minute elevation change in the strike of the bullet.
 - (2) Altitude/barometric pressure. Since the air pressure is less at higher altitudes, the air is less dense. Thus, the bullet is more efficient and impacts higher due to less drag. (Table 3 1 shows the approximate effect of change of the point of impact from sealevel to 10,000 feet if the rifle is zeroed at sea level.) Impact will be the point of aim at sea level. For example, a rifle zeroed at sea level and fired at a range of 700 meters at an altitude of 5,000 feet will hit 1.6 minutes high.

RANGE (METERS)	2,500 FEET *(ASL)	5,000 FEET (ASL)	10,000 FEET (ASL)
100	.05	.08	.13
200	.1	.2	.34
300	.2	.4	.6
400	.4	.5	.9
500	.5	.9	1.4
600	.8	1.0	1.8
700	1.0	1.6	2.4
800	1.3	1.9	3.3
900	1.6	2.8	4.8
1,000	1.8	3.7	6.0
*ABOVE SEA LEVEL			

Table 3-1. Point of Impact rises as altitude increases (data are in MOA).

(3) Humidity. Humidity varies along with the altitude and temperature. Figure 3-19 considers the changes in altitudes. Problems can occur if extreme humidity changes exist in the area of operations. That is, when humidity goes up, impact goes down; when humidity goes down, impact goes up. Since impact is affected by humidity, a 20 percent change in humidity equals about one minute as a rule of thumb. Keeping a good sniper data book during training and acquiring experience are the best teachers.

(4) Efficiency of the bullet. This is called a bullet's ballistic coefficient. The imaginary perfect bullet is rated as being 1.00. Match bullets range from .500 to about .600. The 7.62-mm special ball (M118) is rated at .530 (Table 3-2).

(5) Wind. Most practice firing conducted by the sniper team involves the use of military range facilities, which are relatively flat. However, as a sniper being deployed to other regions of the world, the chance exists for operating in a mountainous or urban environment. This requires target engagements at higher and lower elevations. Unless the sniper takes corrective action, bullet impact will be above the point of aim. How high the bullet hits is determined by the range and angle to the target (Table 3-3). The amount of elevation change applied to the telescope of the rifle for angle firing is known as slope dope.

RANGE (METERS)	(A)	(B)	(C)	(D)
100	2,407	.7	NA	.1
200	2,233	3.0	1.5	.2
300	2,066	7.3	3.0	.4
400	1,904	14.0	3.5	.5
500	1,750	24.0	4.0	.7
600	1,603	37.6	4.5	.9
700	1,466	56.2	5.0	1.0
800	1,339	80.6	5.0	1.3
900	1,222	112.5	6.0	1.5
1,000	1,118	153.5	7.0	1.8

(A) RETAINED VELOCITY (FEET PER SECOND).
(B) MIDRANGE TRAJECTORY (INCHES).
(C) BULLET DROP IN 100-METER INCREMENTS (MINUTES).
(D) TIME OF FLIGHT (SECONDS).

Table 3-2. Muzzle velocity data for 7.62-mm special ball (M118).

RANGE (METERS)	SLANT DEGREES											
	5	10	15	20	25	30	35	40	45	50	55	60
100	.01	.04	.09	.16	.25	.36	.49	.63	.79	.97	1.2	1.4
200	.03	.09	.2	.34	.53	.76	1.	1.3	1.7	2.	2.4	2.9
300	.03	.1	.3	.5	.9	1.2	1.6	2.1	2.7	3.2	3.9	4.5
400	.05	.19	.43	.76	1.2	1.7	2.3	2.9	3.7	4.5	5.4	6.3
500	.06	.26	.57	1.	1.6	2.3	3.	3.9	4.9	6.	7.2	8.4
600	.08	.31	.73	1.3	2.	2.9	3.9	5.	6.3	7.7	9.2	10.7
700	.1	.4	.9	1.6	2.5	3.6	4.9	6.3	7.9	9.6	11.5	13.4
800	.13	.5	1.	2.	3.	4.4	5.9	7.7	9.6	11.7	14.	16.4
900	.15	.6	1.3	2.4	3.7	5.3	7.2	9.3	11.6	14.1	16.9	19.8
1,000	.2	.7	1.6	2.8	4.5	6.4	8.6	11.	13.9	16.9	20.2	23.7

*RANGE GIVEN IS SLANT RANGE (METERS), NOT MAP DISTANCE.

Table 3-3. Bullet rise at given angle and range in minutes.

For the highly trained sniper, the effects of weather are the main causes of error in the strike of the bullet. Wind, mirage, light, temperature, and humidity affect the bullet, the sniper, or both. Some effects are minor; however, sniping is often done in extremes of weather and all effects must be considered.

Wind poses the biggest problem for the sniper. The effect that wind has on the bullet increases with range. This is due mainly to the slowing of the bullet's velocity combined with a longer flight time. This allows the wind to have a greater effect on the round as distances increase. The result is a loss of stability.

a. Wind also has a considerable effect on the sniper. The stronger the wind, the more difficult it is for him to hold the rifle steady. This can be partly offset by training, conditioning and the use of supported positions.

b. Since the sniper must know how much effect the wind will have on the bullet, he must be able to classify the wind. The best method is to use the clock system (Figure 3-19). With the sniper at the center of the clock and the target at 12 o'clock, the wind is assigned three values: full, half, and no value. Full value means that the force of the wind will have a full effect on the flight of the bullet. These winds come from 3 and 9 o'clock. Half value means that a wind at the same speed, but from 1,2,4,5,7,8, 10, and 11 o'clock, will move the bullet only half as much as a full-value wind. No value means that a wind from 6 or 12 o'clock will have little or no effect on the flight of

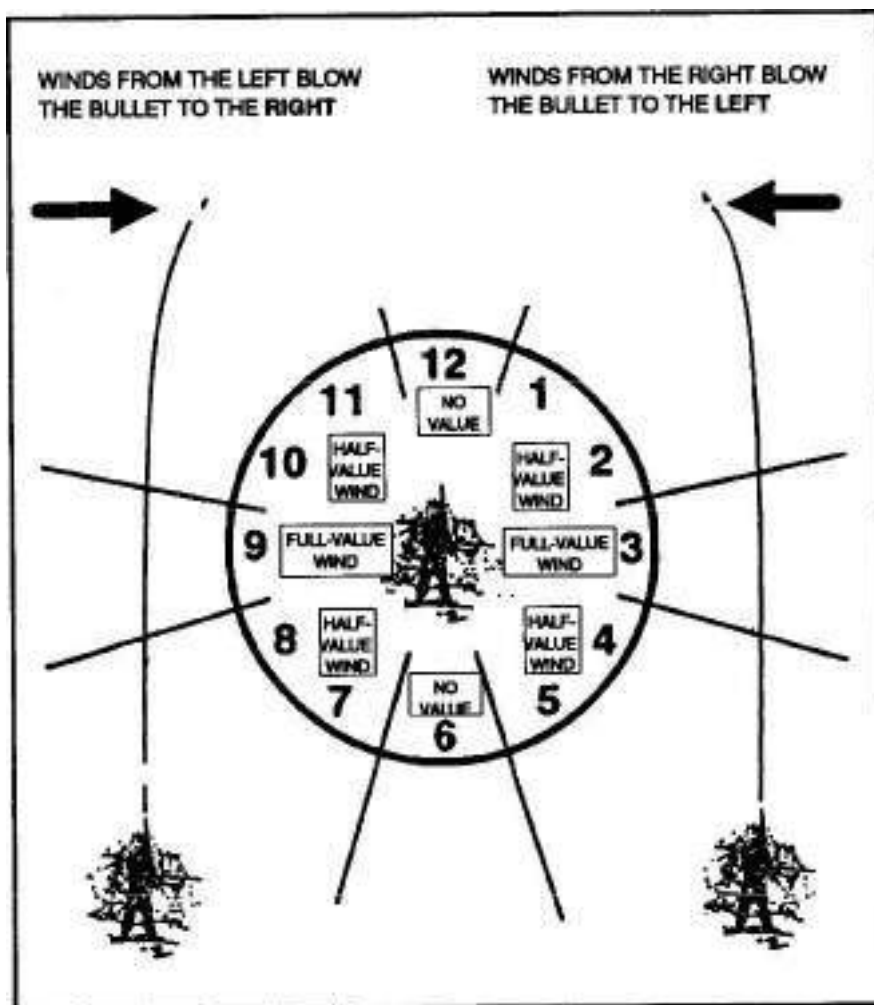

Figure 3-19. Clock system.

Before adjusting the sight to compensate for wind, the sniper must determine wind direction and velocity. He may use certain indicators to accomplish this. These are range flags, smoke, trees, grass, rain, and the sense of feel. However, the preferred method of determining wind direction and velocity is reading mirage (see paragraph d below). In most cases, wind direction can be determined simply by observing the indicators.

a. A common method of estimating the velocity of the wind during training is to watch the range flag (Figure 3-20). The sniper determines the angle between the flag and pole, in degrees, then divides by the constant number 4. The result gives the approximate velocity in miles per hour.

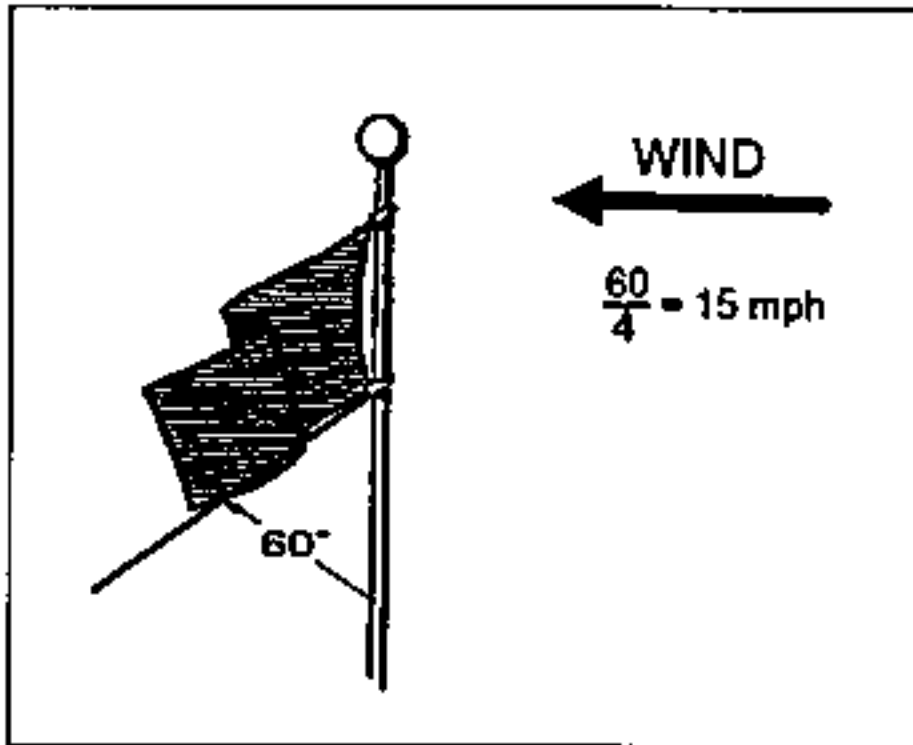

Figure 3-20. The Flag method.

b. If no flag is visible, the sniper holds a piece of paper, grass, cotton, or some other light material at shoulder level, then drops it. He then points directly at the spot where it lands and divides the angle between his body and arm by the constant number 4. This gives him the approximate wind velocity in miles per hour.

c. If these methods cannot be used, the following information is helpful in determining velocity. Winds under 3 miles per hour can barely be felt, although smoke will drift. A3- to 5-mile-per-hour wind can barely be felt on the face. With a 5- to 8-mile-per-hour wind, the leaves in the trees are in constant motion, and with a 12- to 15-mile-per-hour wind, small trees begin to sway.

d. A mirage is a reflection of the heat through layers of air at different temperatures and density as seen on a warm day (Figure 3-21). With the telescope, the sniper can see a mirage as long as there is a difference in ground and air temperatures. Proper reading of the mirage enables the sniper to estimate wind speed and direction with a high degree of accuracy. The sniper uses the M49 observation telescope to read the mirage. Since the

wind nearest to midrange has the greatest effect on the bullet, he tries to determine velocity at that point. He can do this in one of two ways:

(1) He focuses on an object at midrange, then places the scope back onto the target without readjusting the focus.

(2) He can also focus on the target, then back off the focus one-quarter turn counterclockwise. This makes the target appear fuzzy, but the mirage will be clear.

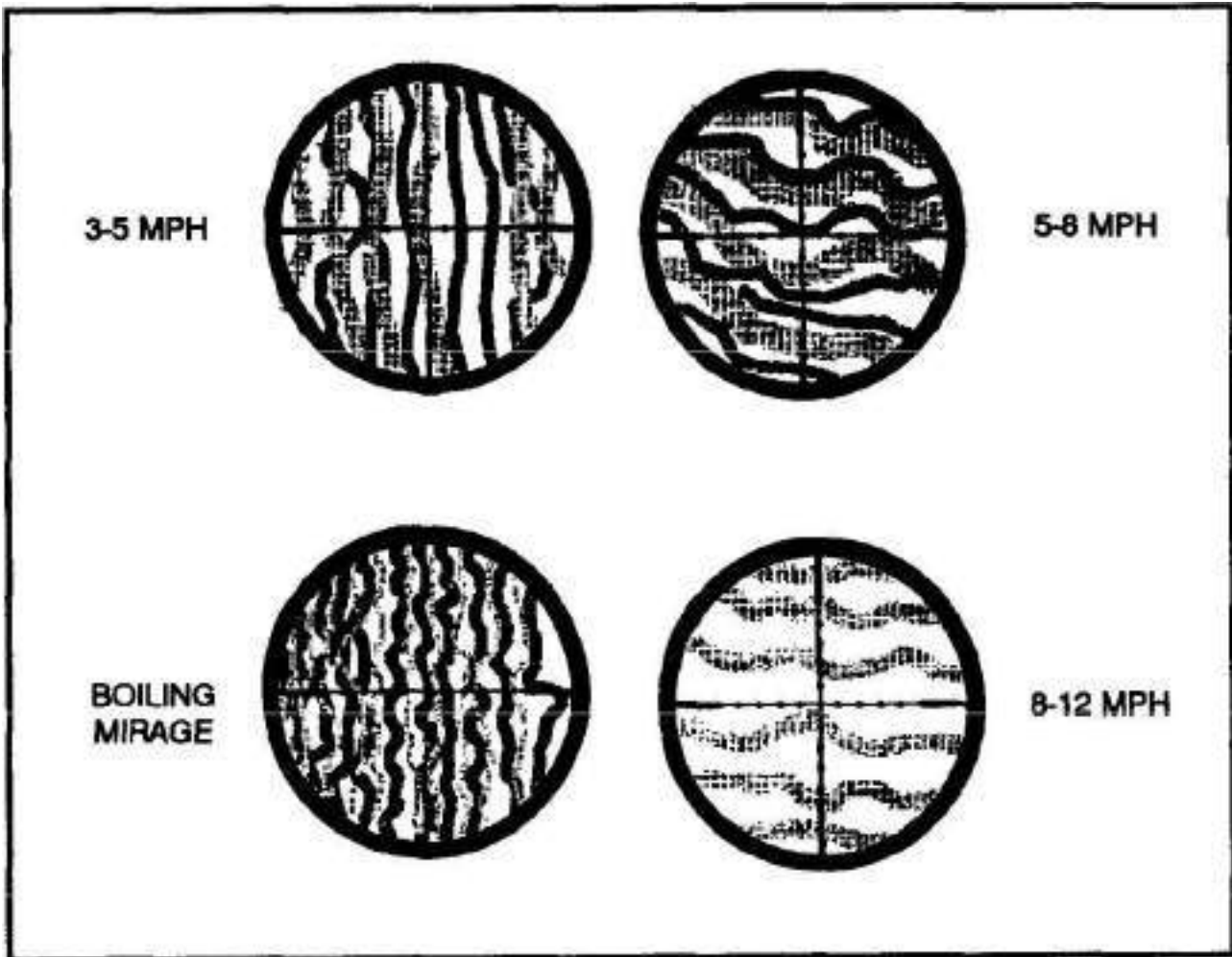

e. As observed through the telescope, the mirage appears to move with the same velocity as the wind, except when blowing straight into or away from the scope. Then, the mirage gives the appearance of moving straight upward with no lateral movement. This is called a boiling mirage. A boiling mirage may also be seen when the wind is constantly changing direction. For example, a full-value wind blowing from 9 o'clock to 3 o'clock suddenly changes direction. The mirage will appear to stop moving from left to right and present a boiling appearance. When this occurs, the inexperienced observer directs the sniper to fire with the "0" wind. As the sniper fires, the wind begins blowing from 3 o'clock to 9 o'clock, causing the bullet to miss the target therefore, firing in a "boil" can hamper shot placement. Unless there is a no-value wind, the sniper must wait until the boil disappears. In general, changes in the velocity of the wind, up to about 12 miles per hour, can be readily determined by observing the mirage. Beyond that speed, the movement of the mirage is too fast for detection of minor changes.

All telescopic sights have windage adjustments that are graduated in minutes of angle or fractions thereof. A minute of angle is 1/60th of a degree. This equals about 1 inch (1.145 inches) for every 100 meters.

EXAMPLE:

- 1 MOA = 2 inches at 200 meters.
- 1 MOA = 5 inches at 500 meters.

a. Snipers use minutes of angle (Figure 3-22, page 3-34) to determine and adjust the elevation and windage needed on the weapon's scope. After finding the wind direction and velocity in miles per hour, the sniper must then convert it into minutes of angle, using the wind formula as a rule of thumb only. The wind formula is—

$$\frac{\text{RANGE (hundreds)} \text{ divided by } 100 \text{ VELOCITY (mph)}}{\text{CONSTANT}} = \text{Minutes full-value wind.}$$

The constant depends on the target's range:

100 to 500	"C" = 15
600	"C" = 14
700 to 800	"C" = 13
900	"C" = 12
1,000	"C" = 11

If the target is 700 meters away and the wind velocity is 10 mph, the formula is—
 $7 \times 10 / 13 = 5.37$ minutes or 5 1/2 minutes. This determines the number of minutes for a full-value wind. For a half-value wind, the 5.38 would be divided in half.

b. The observer makes his own adjustment estimations, then compares them to the wind conversion table, which can be a valuable training tool. He must not rely on this table; if it is lost, his ability to perform the mission could be severely hampered. Until the observer gains skill in estimating wind speed and computing sight changes, he may refer to Table 3-4 on the next page.

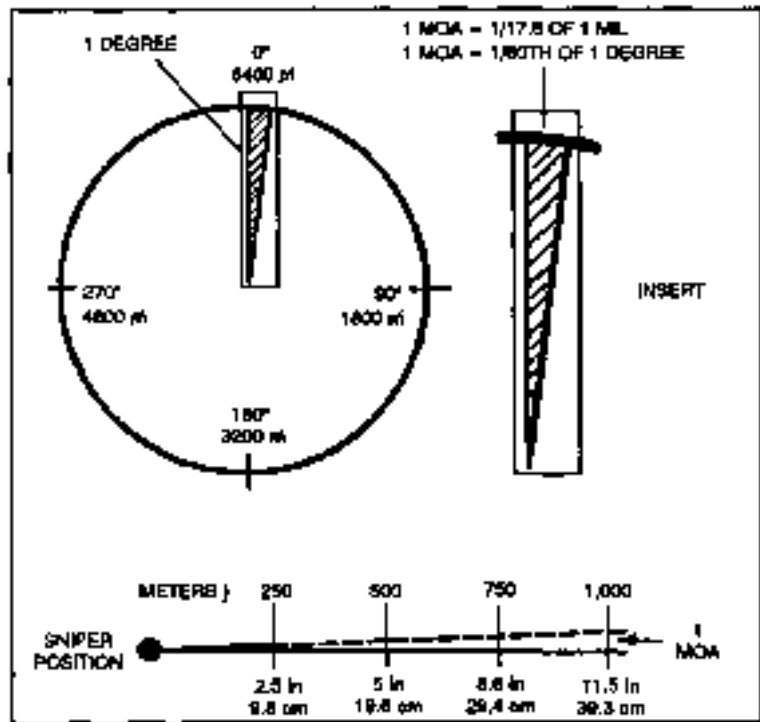

Figure 3-22. Minutes of angle.

RANGE (METERS)	WIND VALUE	3 MPH		5 MPH		7 MPH		10 MPH	
		MIN	IN	MIN	IN	MIN	IN	MIN	IN
200	HALF	0.0	0.4	0.5	0.8	0.5	0.8	0.5	1.2
	FULL	0.5	0.8	0.5	1.2	1.0	1.7	1.0	2.4
300	HALF	0.5	0.9	0.5	1.3	0.5	1.9	1.0	2.7
	FULL	0.5	1.7	1.0	2.7	1.0	3.6	1.5	5.4
400	HALF	0.5	1.4	0.5	2.4	1.0	3.3	1.0	4.8
	FULL	0.5	2.9	1.0	4.8	1.5	6.7	2.0	9.8
500	HALF	0.5	2.3	0.5	3.8	1.0	5.3	1.5	7.5
	FULL	1.0	4.5	1.5	7.5	2.0	10.5	2.5	15.0
600	HALF	0.5	3.0	1.0	5.0	1.0	6.0	1.5	11.0
	FULL	1.0	7.0	1.5	11.0	2.5	15.0	3.5	21.0
700	HALF	0.5	4.0	1.0	7.0	1.5	10.0	2.0	15.0
	FULL	1.0	8.0	2.0	15.0	2.5	21.0	4.0	29.0
800	HALF	0.5	5.0	1.0	10.0	1.5	13.0	2.0	19.0
	FULL	1.5	11.0	2.0	19.0	3.0	27.0	4.5	38.0
900	HALF	0.5	7.0	1.0	12.0	1.5	17.0	2.5	24.0
	FULL	3.5	15.0	2.5	24.0	3.5	34.0	5.0	49.0
1000	HALF	1.0	9.0	1.5	15.0	2.0	21.0	2.5	30.0
	FULL	1.5	19.0	2.5	30.0	4.0	42.0	5.5	60.0

RANGE (METERS)	WIND VALUE	12 MPH		15 MPH		18 MPH		25 MPH	
		MIN	IN	MIN	IN	MIN	IN	MIN	IN
200	HALF	0.5	1.3	1.0	1.8	1.0	2.2	1.0	2.4
	FULL	1.5	2.9	1.5	3.6	2.0	4.3	2.0	4.8
300	HALF	1.0	3.3	1.0	4.0	1.5	4.9	1.5	5.4
	FULL	2.0	5.5	2.5	8.1	3.0	9.8	3.5	10.9
400	HALF	1.5	5.8	1.5	7.2	2.0	8.8	2.0	9.6
	FULL	2.5	11.5	3.5	14.4	4.0	17.3	4.5	19.2
500	HALF	1.5	8.0	2.0	11.3	2.5	13.5	2.0	15.0
	FULL	3.5	18.0	4.0	22.8	5.0	27.0	5.5	30.0
600	HALF	1.5	13.0	2.5	16.0	3.0	19.0	3.5	22.0
	FULL	4.0	28.0	5.0	32.0	5.0	38.0	5.5	43.0
700	HALF	2.5	18.0	3.0	22.0	3.5	25.0	4.0	29.0
	FULL	4.5	35.0	5.0	44.0	7.0	53.0	7.5	59.0
800	HALF	2.5	23.0	3.5	29.0	4.0	35.0	4.5	38.0
	FULL	5.5	49.0	6.5	57.0	9.0	69.0	9.0	77.0
900	HALF	3.0	29.0	3.5	36.0	4.5	44.0	5.0	49.0
	FULL	6.0	59.0	7.5	73.0	9.0	87.0	10.0	87.0
1000	HALF	3.5	38.0	4.0	45.0	5.0	54.0	5.5	60.0
	FULL	6.5	72.0	8.0	90.0	10.0	103.0	11.5	120.0

Table 3-4. Wind conversion table.

Effects of light. Light does not affect the trajectory of the bullet; however, it does affect the way the sniper sees the target through the scope. This effect can be compared to the refraction (bending) of light through a medium, such as a prism or a fish bowl. The same effect, although not as drastic, can be observed on a day with high humidity and with sunlight from high angles. The only way the sniper can adjust for this effect is to refer to past firing recorded in the sniper data book. He can then compare different light and humidity conditions and their effect on marksmanship. Light may also affect firing on unknown distance ranges since it affects range determination capabilities.

Effects of temperature. Temperature affects the firer, ammunition, and density of the air. When ammunition sits in direct sunlight, the burn rate of powder is increased, resulting in greater muzzle velocity and higher impact. The greatest effect is on the density of the air. As the temperature rises, the air density is lowered. Since there is less resistance, velocity increases and once again the point of impact rises. This is in relation to the temperature at which the rifle was zeroed, If the sniper zeros at 50 degrees and he is now firing at 90 degrees, the point of impact rises considerably. How high it rises is best determined once again by past firing recorded in the sniper data book. The general rule, however, is that when the rifle is zeroed, a 20-degree increase in temperature will raise the point of impact by one minute; conversely, a 20-degree decrease will drop the point of impact by one minute.

Effects of humidity. Humidity varies along with the altitude and temperature. The sniper can encounter problems if drastic humidity changes occur in his area of operation. Remember, if humidity goes up, impact goes down; if humidity goes down, impact goes up. As a rule of thumb, a 20-percent change will equal about one minute, affecting the point of impact. The sniper should keep a good sniper data book during training and refer to his own record.

Estimating Range

A sniper team is required to accurately determine distance, to properly adjust elevation on the sniper weapon system, and to prepare topographical sketches or range cards. Because of this, the team has to be skilled in various range estimation techniques. Three factors affect range estimation: nature of the target, nature of the terrain, and light conditions.

a. Nature of the Target.

- (1) An object of regular outline, such as a house, appears closer than one of irregular outline, such as a clump of trees.
- (2) A target that contrasts with its background appears to be closer than it actually is.
- (3) A partly exposed target appears more distant than it actually is.

b. Nature of the Terrain.

- (1) As the observer's eye follows the contour of the terrain, he tends to overestimate distant targets.
- (2) Observing over smooth terrain, such as sand, water, or snow, causes the observer to underestimate distant targets.
- (3) Looking downhill, the target appears farther away.
- (4) Looking uphill, the target appears closer.

c. Light Conditions.

- (1) The more clearly a target can be seen, the closer it appears.
- (2) When the sun is behind the observer, the target appears to be closer.
- (3) When the sun is behind the target, the target is more difficult to see and appears to be farther away.

Sniper teams use range estimation methods to determine distance between their position and the target.

a. Paper-Strip Method. The paper-strip method is useful when determining longer distances (1,000 meters plus). When using this method, the sniper places the edge of a strip of paper on the map and ensures it is long enough to reach between the two points. Then he pencils in a tick mark on the paper at the team position and another at the distant location. He places the paper on the map's bar scale, located at the bottom center of the map, and aligns the left tick mark with the 0 on the scale. Then he reads to the right to the second mark and notes the corresponding distance represented between the two marks.

b. 100-Meter-Unit-of-Measure Method. To use this method, the sniper team must be able to visualize a distance of 100 meters on the ground. For ranges up to 500 meters, the team determines the number of 100-meter increments between the two objects it wishes to measure. Beyond 500 meters, it must select a point halfway to the object and determine the number of 100-meter increments to the halfway point, then double it to find the range to the object.

c. Appearance-of-Object Method. This method is a means of determining range by the size and other characteristic details of the object. To use the appearance-of-object method with any degree of accuracy, the sniper team must be familiar with the characteristic details of the objects as they appear at various ranges.

d. Bracketing Method. Using this method, the sniper team assumes that the target is no more than X meters but no less than Y meters away. An average of X and Y will be the estimate of the distance to the target.

e. Range-Card Method. The sniper team can also use a range card to quickly determine ranges throughout the target area. Once a target is seen, the team determines where it is located on the card and then reads the proper range to the target.

f. Mil-Relation Formula. The mil-relation formula is the preferred method of range estimation. This method uses a mil-scale reticle located in the M19 binoculars (Figure 4-19) or in the M3A sniperscope (Figure 4-20). The team must know the target size in inches or meters. Once the target size is known, the team then compares the target size to the mil-scale reticle and uses the following formula:

$$\frac{\text{Size of target in meters} \times 1,000}{\text{Size of object in mils}} = \text{Range to target in meters.}$$

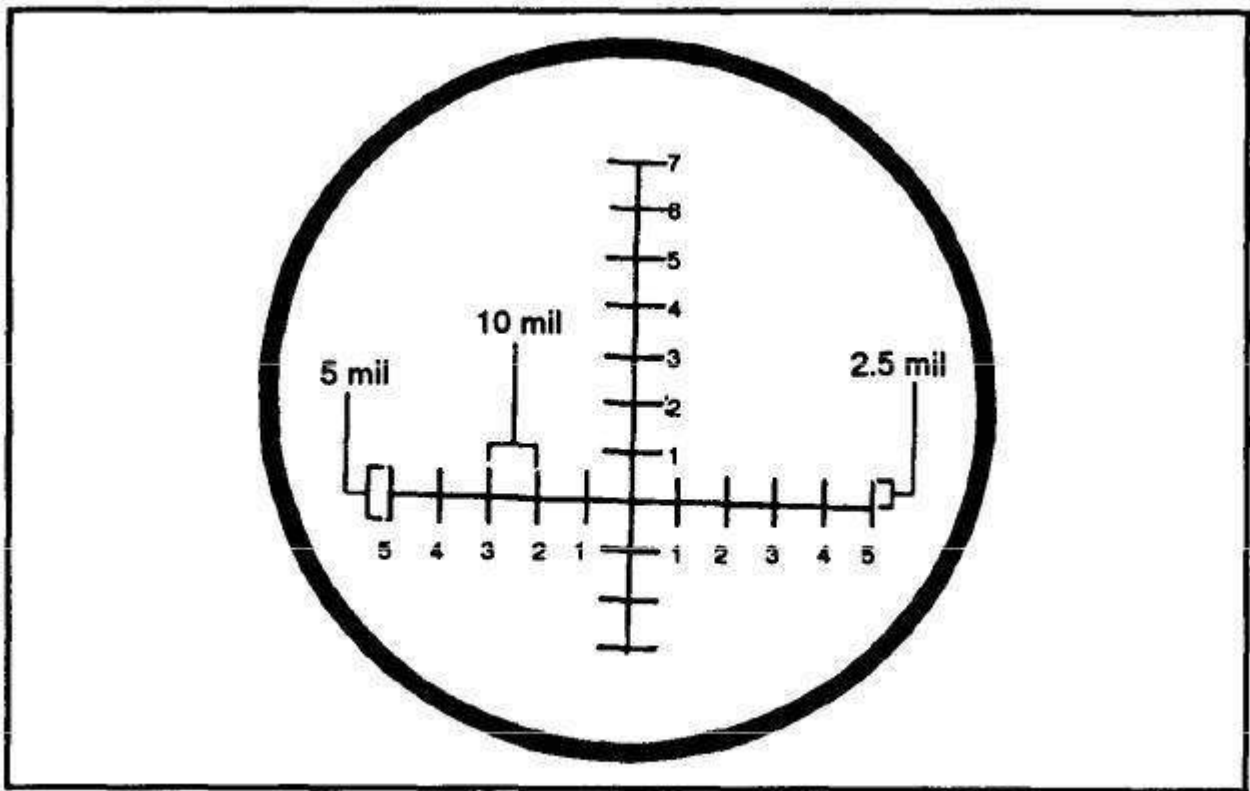

Figure 4-19. M19 mil-scale reticle.

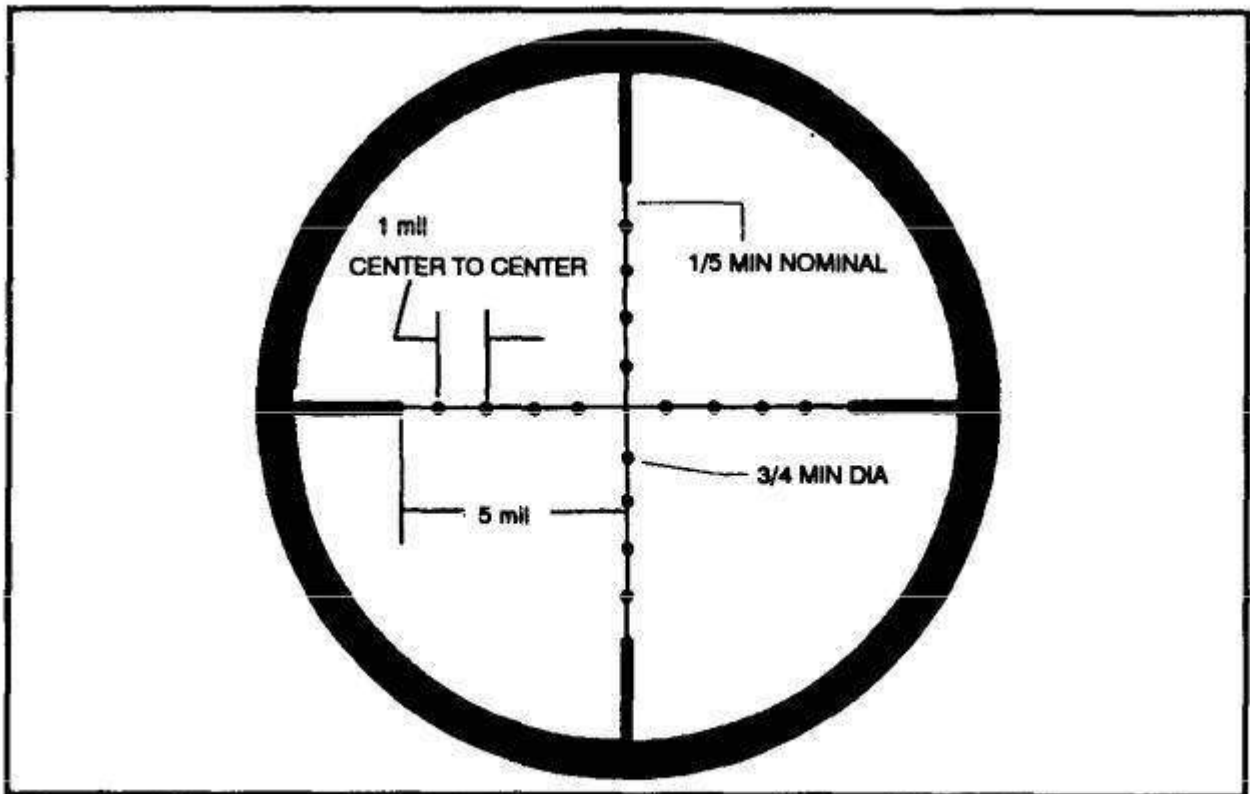

Figure 4-20. M3A mil-scale reticle.

g. Combination Method. In a combat environment, perfect conditions rarely exist. Therefore, only one method of range estimation may not be enough for the team's specific mission. Terrain with much dead space limits the accuracy of the 100-meter method. Poor visibility limits the use of the appearance-of-object method. However, by using a combination of two or more methods to determine an unknown range, an experienced sniper team should arrive at an estimated range close to the true range.

When the target is estimated to be 70 inches high, divide the height into one-half. Use the following mil-relation formula:

$$35 \text{ inches} \times .0254 \times 1,000 = \text{Range to target in meters.}$$

Size of target in mils

SNIPER'S RANGE CARD
For use of this form, see FM 23-10; the proposed agency is 770000

RN# 6

NAME: **DOE, JOHN** METHOD OF OBTAINING RANGE: **MIL RELATION**

RANGE	100	200	300	400	500	600	700	800	900	1000	1100	1200	1300	1400	1500	1600	1700	1800	1900	2000	RANGE
ELEVATION	1	2	3	4	5	6	7	8	9	10	11	12	13	14	15	16	17	18	19	20	ELEVATION
WINDAGE	1	2	3	4	5	6	7	8	9	10	11	12	13	14	15	16	17	18	19	20	WINDAGE
TEMPERATURE		WIND		TRP 1		TRP 2		TRP 3													
HIGH	LOW	VELOCITY	DIRECTION	AZIMUTH	DISTANCE	AZIMUTH	DISTANCE	AZIMUTH	DISTANCE												
75	65	10 MPH	E/W	219°	700 m	272°	300 m	315°	650 m												
				DESCRIPTION		DESCRIPTION		DESCRIPTION													
				ROAD INTERSECTION		BRIDGE		INTERSECTION													

DA FORM 5787-R, JUN 89

Figure 4-21. Example of completed DA Form 5787-R.

The best method (saved for last) is using a range card. The range card represents the target area drawn as seen from above with annotations indicating distances throughout the target area. Information is recorded on DA Form 5787-R (Sniper's Range Card) (Figure 4-21). (A blank copy of this form is located in the back of this publication for local reproduction.) The range card provides the sniper team with a quick-range reference and a means to record target locations, since it has preprinted range rings on it. These cards can be divided into sectors by using dashed lines. This provides the team members with a quick reference when locating targets—for example: "The intersection in sector A." A range

card can be prepared on any paper the team has available. The sniper team position and distances to prominent objects and terrain features are drawn on the card. There is not a set maximum range on the range card, because the team may also label any indirect fire targets on its range card. Information contained on range cards includes:

- Name, rank, SSN, and unit.
- Method of obtaining range.
- Left and right limits of engageable area.
- Major terrain features, roads, and structures.
- Ranges, elevation, and windage needed at various distances.
- Distances throughout the area.
- Temperature and wind. (Cross out previous entry whenever temperature, wind direction, or wind velocity changes.)
- Target reference points (azimuth, distance, and description).

Data Book

The sniper data book contains a collection of data cards. The sniper uses the data cards to record firing results and all elements that had an effect on firing the weapon. This can vary from information about weather conditions to the attitude of the firer on that particular day. The sniper can refer to this information later to understand his weapon, the weather effects, and his shooting ability on a given day. One of the most important items of information he will record is the cold barrel zero of his weapon. A cold barrel zero refers to the first round fired from the weapon at a given range. It is critical that the sniper shoots the first round daily at different ranges. For example, Monday, 400 meters; Tuesday, 500 meters; Wednesday, 600 meters. When the barrel warms up, later shots begin to group one or two minutes higher or lower, depending on specific rifle characteristics. Information is recorded on DA Form 5785-R (Sniper's Data Card) (Figure 3-23).

SNIPER'S DATA CARD						DISTANCE TO TARGET _____ METERS						
For use of this form, see FM 20-75 for procedural agency to TRADOC												
RANGE	RIFLE AND SCOPE NO				DATE	ELEVATION		WINDAGE				
Colony	73295678				1234	85	JAN	98	USED	CORRECT	USED	CORRECT
AMMO	LIGHT	Mirage	TEMP	HOUR	HOLD	6		6+1		L/24		
LC-734	CLEAR	FAIR	55°	1100								
LIGHT			WIND									
SHOT	1	2	3	4	5	6	7	8	9	10	REMARKS	
ELEV	6	6	2	0	7	1	2	2	1	2	PULLED	
WIND	0	2	4	2	2	2	2	2	2	2	WAS COLD	
G											FIRE TIME	
A											10 MINS	
L											10 MINS	

NOTE: THE REQUIRED TARGETS WILL BE DRAWN IN BY HAND TO MEET THE NEEDS OF THE UNIT.

DA FORM 5785-R, JUN 88

Figure 3-23. Example of completed DA Form 5785-R.

Three phases in writing information on the data card (Figure 3-23) are before firing, during firing, and after firing.

a. Before Firing. Information that is written before firing is—

- (1) Range. The distance to the target.
- (2) Rifle and scope number. The serial numbers of the rifle and scope.
- (3) Date. Date of firing.
- (4) Ammunition. Type and lot number of ammunition.
- (5) Light. Amount of light (overcast, clear, and so forth).
- (6) Mirage. Whether a mirage can be seen or not (good, bad, fair, and so forth).
- (7) Temperature. Temperature on the range.
- (8) Hour. Time of firing.
- (9) Light (diagram). Draw an arrow in the direction the light is shining.
- (10) Wind. Draw an arrow in the direction the wind is blowing, and record its average velocity and cardinal direction (N, NE, S, SW, and so forth).

b. During Firing. Information that is written while firing is—

- (1) Elevation. Elevation setting used and any correction needed. For example: The target distance is 600 meters; the sniper sets the elevation dial to 6. The sniper fires and the round hits the target 6 inches low of center. He then adds one minute (one click) of elevation (+1).
- (2) Windage. Windage setting used and any correction needed. For example The sniper fires at a 600-meter target with windage setting on 0; the round impacts 15 inches right of center. He will then add 2 1/2 minutes left to the windage dial (L/2 1/2).
- (3) Shot. The column of information about a particular shot. For example: Column 1 is for the first round; column 10 is for the tenth round.
- (4) Elevation. Elevation used (6 +1, 6,6 -1, and so on).
- (5) Wind. Windage used (L/2 1/2, O, R/1/2, and so on).
- (6) Call. Where the aiming point was when the weapon fired.
- (7) Large silhouette. Used to record the exact impact of the round on the target. This is recorded by writing the shot's number on the large silhouette in the same place it hit the target.

c. After Firing. After firing, the sniper records any comments about firing in the remarks section. This can be comments about the weapon, firing conditions (time allowed for fire), or his condition (nervous, felt bad, felt good, and so forth).

When the sniper leaves the firing line, he compares weather conditions to the information needed to hit the point of aim/point of impact. Since he fires in all types of weather conditions, he must be aware of temperature, light, mirage, and wind. The sniper must consider other major points or tasks to complete.

- a. Compare sight settings with previous firing sessions. If the sniper always has to fine-tune for windage or elevation, there is a chance he needs a sight change (slip a scale).
- b. Compare ammunition by lot number for best rifle and ammunition combination.
- c. Compare all groups fired under each condition. Check the low and high shots as well as those to the left and the right of the main group—the less dispersion, the better. If groups are tight, they are easily moved to the center of the target; if loose, there is a problem. Check the scope focus and make sure the rifle is cleaned correctly. Remarks in the sniper data book will also help.
- d. Make corrections. Record corrections in the sniper data book, such as position and sight adjustment information, to ensure retention.

e. Analyze a group on a target. This is important for marksmanship training. The firer may not notice errors during firing, but errors become apparent when analyzing a group. This can only be done if the sniper data book has been used correctly. A checklist that will aid in shot group/performance analysis follows:

- (1) Group tends to be low and right.
 - Left hand not positioned properly.
 - Right elbow slipping.
 - Improper trigger control.
- (2) Group scattered about the target.
 - Incorrect eye relief or sight picture.
 - Concentration on the target (iron sights).
 - Stock weld changed.
 - Unstable firing position.
- (3) Good group but with several erratic shots.
 - Flinching. Shots may be anywhere.
 - Bucking. Shots from 7 to 10 o'clock.
 - Jerking. Shots may be anywhere.
- (4) Group strung up and down through the target.
 - Breathing while firing.
 - Improper vertical alignment of cross hairs.
 - Stock weld changed.
- (5) Compact group out of the target.
 - Incorrect zero.
 - Failure to compensate for wind.
 - Bad natural point of aim.
 - Scope shadow.
- (6) Group center of the target out the bottom.
 - Scope shadow.
 - Position of the rifle changed in the shoulder.
- (7) Horizontal group across the target.
 - Scope shadow.
 - Canted weapon.
 - Bad natural point of aim.

CHAPTER XIV: POISONS

Note: This section was largely written by Anders Behring Breivik.

Poison	Availability	LD50 for a 75 kg person
Tetrodotoxin (globefish toxin)	Hard	0,75 mg
Hydrogen cyanide	Hard	30 mg
Sodium cyanide	Hard	40 mg
Potassium Cyanide	Moderate	60 mg
Ricin	Moderate	60 mg
Nicotine 100% pure	Easy	60-80 mg
Saxitoxin (shellfish poison)	N/A	60 mg
Diarsenic Pentoxide	N/A	600 mg
Carbofuran (a pesticide)	N/A	750 mg
Heroin (50-75% pure)	Easy	1 g
LSD	Easy	1,2 g
Phosphamidon (an insecticide)	N/A	1,8 g
Arsenic	Moderate	57 g
Potassium Chloride	Moderate	190 g

Lab equipment needed:

- Hazmat suit (inhaled or skin-absorbed poison fumes/particles can kill you).
- Full facemask with correct toxin filters.
- A box of latex gloves.
- Proper ventilation.

Exercise great care when purifying and handling poisons. You need to set up a lab and ensure that you have proper ventilation. Buy a hazmat suit. Lakeland Dupont Tychem F suits with hoods and boots are available for as low as 11 USD on Ebay (I got mine for this price). Buy a face mask; for example a 3M 6800 full face respirator with appropriate filters (choose Organic Vapor/Organic Vapor-Acid/Organic Vapor-Acid-Gas filters) depending on the chemicals you will be working with. You can buy this facemask with filters from Ebay for as low as 100 USD (I got my mask with filters for 130 USD incl. shipping).

(The following section is written by Cpl. Vernon Itas).

The synthesis of poisons is not a project to be undertaken lightly. It is one of the most dangerous projects which can be done in the laboratory. The danger comes from the fact that a little bit on the skin translates into a miserable death minutes later. Beginners at organic synthesis are notorious for spilling the things they are cooking onto themselves, so this is a job for a seasoned veteran. For this reason, a certain amount of chemical expertise will be assumed in the following section. It is meant to be fully understood by anyone who has made it through a couple semesters of college-level organic chemistry.

The equipment needed for production of poison is basically the same as that needed to produce any other of a wide range of organic chemicals. The standard distilling kit with a variety of sizes of round-bottom flasks is a must, as is a magnetic stirrer-hotplate and a good source of vacuum such as a properly working aspirator.

Using the gas mask filter in combination with a fan to produce a positive flow filtered air environment in a room or the inside of a car. A fan draws air into the vehicle through the mask filter which reacts out the nerve agents. The clean air then pushes out and displaces the air in the vehicle through the cracks and crevices. This prevents the toxic gas from seeping into your protected environment.

Protection against nerve agents usually involves creating physical barriers against exposure to the chemicals and reacting them to less toxic forms with moisture and chemicals. Full body protective suits in combination with gas masks or scuba gear prevent contact with skin surfaces or breathing in the agent. Washing off the suits in a shower before taking them off reduces potential exposure from residues. For ordinary citizens, the only available protection is usually a gas mask. This can be supplemented with a number of field improvised protections.

Military gas masks are designed with filter pads (six core layers laminated between two packing layers) composed of viscose rayon, vinyon, and glass fibers. The core layers are impregnated with 75% Whetlerite which is a finely ground activated carbon which has been immersed in a solution of ammoniacal solution of silver, copper, chromium, and carbon dioxide. It is then dried at temperatures high enough to drive off ammonia from the resulting granules. This formula provides complete protection against all known military toxic chemical agents but does not protect against some industrial toxics like ammonia, chlorine gas, and carbon monoxide.

(Back to Anders Behring Breivik).

Nicotine

Pure nicotine is one of the most deadly poisons on earth. Pure nicotine (99%-99.5%) from China is typically solvent extracted from tobacco leaves and is described as a clear to yellowish oily liquid. This is generally sold by Kg (weight) as opposed to volume (L). However from all I've seen, these liquids have the same density as water 1kg=1L.

Nicotine initially causes a burning sensation in mouth and throat, then salivation, nausea, abdominal pain, vomiting and diarrhea. Then systemic effect in clagitation, headache, sweating, dizziness, auditory and visual disturbances, confusion, weakness and incoordination. At first respirations are deep and rapid, blood pressure is high and pulse is slow. Intense vagal stimulation may cause transient cardiac standstill or paroxysmal atrial fibrillation. Pupils are generally constricted. Central nervous excitation is also evidenced by tremors and sometimes by clonic-tonic convulsions. As depression develops, the pupils dilate, the blood pressure falls and the pulse becomes rapid and often irregular. Faintness, prostration, cyanosis and dyspnea progress to collapse. Death from paralysis of respiratory muscles, usually only a few minutes after collapse.

There is a cure, but it has to be injected within 5-20 minutes after nicotine overdose. Dying from nicotine overdose is considered a horrible and painful death.

Nicotine fumes last about half an hour in air environment. In its pure form, which is called "freebase nicotine", it reacts chemically with oxygen in the air, with water, and most other living tissues, destroying them instantly. Freebase nicotine is highly poisonous and is

sometimes used as an insecticide. It makes a good insecticide because it only lasts about half an hour in the environment, being so unstable in the presence of air. In very small amounts, freebase nicotine can be injected into a person's bloodstream and has an effect almost identical to cocaine.

Market price is currently 150 USD for 1Kg of 99% pure liquid nicotine + 160 USD DHL shipping = 310 USD total. I just ordered a sample batch of 50 ml for a total of 80 USD including shipping. If it doesn't get through customs I will have to extract nicotine from tobacco. Snus and cigarettes can be used as sources of nicotine.

In theory, snus seems like the most cost efficient alternative when it comes to extraction of nicotine. However, it is allegedly a lot easier to extract nicotine from tobacco so choosing snus as the source for extraction is not recommended. At least, this is according to 4 individuals who apparently tried 20 different methods for extracting nicotine from snus (found sources on e-cig forum). I will make an attempt myself on extracting from both snus and tobacco to confirm this, if my Chinese parcel is seized.

Decoction is a method of extraction by boiling of plant material. The method of extraction is very simple:

Snus: Put loose snus in tea bags, boil, then filter, then boil again etc (Similar to tobacco approach). I've also heard that microwave-boiling snus in water for a two-three minutes will yield even better results.

Cigarettes: 3 guides are provided.

Guide 1: Water alone will do the job. Just add tobacco to hot water, heat it to boiling, strain off solids, and then filter the stuff. Boil down the remaining water until it is supersaturated. Then, let it cool slowly. Add a seed crystal or scrape the sides of the smooth container with a glass stirring rod (or a spoon if nothing else is available). Filter the crystals that form in the solution with vacuum filtration. A good way to do this is by putting a coffee filter in a funnel, then putting the funnel spout-down in a running wet/dry vac.

Guide 2: This entire process took about 3-4 hours to complete. I would recommend a gas stove or be very careful and patient with an electric stove top. Get some distilled water and a measuring cup. Also filters for a drip coffee machine.

1. Put the tobacco in a sauce pan (1 quart).
2. Add two cups of the distilled water. Bring this to a slow rolling boil, stirring about every 3-4 minutes.
3. Simmer until you have about a 1/3 cup of liquid remaining. It is very important to not turn the heat up to high or you have a bunch of sticky thick useless stuff, or so I have heard.
4. Let cool about 10 mins.
5. I taped my coffee filter around the outside lip of a 12oz ceramic coffee cup and poured this mixture into the filter. Some of the juice seeped through, most did not.
6. I finally, after about a half hour, untaped the filter, being careful to not dump the tobacco into my juice. I folded the filter up and squeezed the remaining juice into the cup. Take the tobacco left in the filter and eat it. (just kidding:P).
7. Place the left over tobacco back into the sauce pan, add 2 cups of the Distilled water and repeat the procedure.

8. This time slow bowl until you have a bit less juice (about a quarter cup). Remember to watch this, do not let it boil down too long or you have a thick sticky mess.
9. Strain it again in a separate container.
10. Combine the two containers of liquid.
11. Strain this again back into the sauce pan.
12. Slow boil again until you have a quarter cup or a bit less.
13. Strain one more time

Guide 3: I myself have been using PGA (95% pure grain alcohol) and a soxhlet extractor to mimic this type of extraction. I then vacuum filter to .22um while it is still in about 250ml PGA (Started with 20gm of cigar tobacco) I use vacuum distillation to recover most of the PGA. I use warm bottom heat to evaporate more of the liquid. It will precipitate out some of the oils. Re-dilute, re-filter, re-recover and re-evaporate. A lot of tars come out at the filtering step. You end up with very dark but low solids

E-Juice: Buy e-juice (liquid with 10% nicotine) and boil down. E-Juice is pretty inexpensive even at \$20 per ounce.

Contents of cigarettes:

1 cig = 10mg nic (approx).

1 pak cig = 20 cigs x 10mg = 200mg nic.

1 carton cigs = 10 paks x 200mg nic = 2000mg nic.

1lb tobacco yields about 3 cartons cigs x 2000mg = 6000mg nic.

1oz eJuice = 30ml x 36mg nic per ml = 1080mg nic per 1oz bottle.

1lb tobacco = 6000mg nic divided by 1080 mg nic per 1 oz eJuice = 5.5 1oz bottles eJuice.

Contents of snus:

Mini portion is usually 4mg/portion.

Standard portion is usually 8mg/portion. Strong portion is usually 12-17 mg/portion.

1. Thunder portionssnus contains 16 mg PER GRAM (Thunder Extra Strong Original Portion), the strongest snus available. (either Thunder or Odin snus).

2. General Ekstra Sterk contains 15 mg per pouch.

A roll (10 boxes) of portion weighs 390 g whereas 240 g is snus.

A roll of loose weighs 620 g whereas 450 g is snus.

Nicotine cover story. Here is a copy of the email I sent to the supplier;

“Hello, My company is in the process of attempting to establish a market for e cigarettes in Norway. In this context we are going to produce a test/research batch of these products with the intention of documenting the effects as a quit-smoking product. Our government’s main argument against allowing commercialization of these specific quit-smoking products is that there is lacking research on this area. We are looking forward to pursue the possibility of choosing you as our main supplier of nicotine base once e-cigarettes can be commercialized in Norway. However, in this initial research phase we only require an initial 30 ml batch of 99% liquid nicotine. I realize that there is a 1 L minimum order but we do not mind paying the full liter price for the 30 ml batch. I assume that you will take all security precautions regarding safe shipping/packing/labeling considering the extremely toxic nature of the compound. Thanks in advance and hope to hear from you soon. Best regards,

Company xxx
Title xxx
Name xxx
Address xxx
Ph: xxx”

You may even consider acquiring a research permit from your government to further the justification and easing the process of acquiring chemicals. Always act in a formal and polite manner when contacting companies.

Note: Anders Breivik acquired this much nicotine not for poisoning assassination operations, but to manufacture poison bullets for a mass-shooting operation. The normal terrorist or guerrilla will not require executing the company cover story for pure nicotine.

Ricin

Ricin is one of the most poisonous naturally occurring substances known to man. Ricin is produced easily and inexpensively, is highly toxic, is stable in aerosolized form, and is difficult to detect. It is extracted from the castor bean by using a specific purification method. A dose of ricin weighing only 70 micrograms (size of 1 salt grain) will kill a person.

Ricin is even more toxic than strychnine and cyanides. Ricin also has the ability to accumulate in the body until a lethal dose is reached. Symptoms of ricin poisoning are stomachache, headache, fever, nausea and vomiting, bloody diarrhea, cold sweat, sleepiness, disorientation, shortage of breath, seizures, and death. Ricin if inhaled or even touched can kill in a day or two.

The mottled seeds of castor bean, which are about the size and shape of large pinto beans, contain two powerful poisons, the alkaloid ricinin and the toxalbumin ricin.

2 guides on how to extract ricin from castor beans will be provided.

Guide 1: This guide will teach you how to extract ricin from your chosen bean. Be forewarned, however; these chemicals are highly toxic and have a high chance of killing you if you are not careful.

Difficulty: Moderate

Instructions:

- Castor beans.
- 10 ounces of water.
- 2 tablespoons of lye.
- Blender.
- Acetone.
- Covered Jar.
- Hazmat suit with 3M 6800 full face mask with organic vapor filter (VERY IMPORTANT).
- Surgical Gloves.
- Coffee Filter.

1. Soak 2-3 ounces of your chosen bean in 10 ounces of water mixed with 2 tablespoons of lye for one hour. You will have to weigh the beans down with something- gravel and rocks from outside should do the trick.

2. Remove the beans, let them dry, and remove the hulls from the beans.
3. Place the beans in a blender with 8-12 ounces of acetone and grind the beans like you would with coffee beans.
4. Pour the mixture into a covered jar and let it stand for about three days.
5. Wearing the hazmat suit, gloves and full face mask, pour it into another jar using the coffee filter, removing as much acetone as possible.
6. Repeat steps 4-5 to filter it a bit more. What you have left will be nearly-pure ricin.

Guide 2: Here's the formula for Ricin. The reason I place this on here is because if you try to make this poison (kills in 4 days, no good cure and the cure is rare) you will probably get some on your skin and die. I wanted the formula just so I could know it. This stuff is extraordinarily poisonous -- arsenic takes 100 granules to kill someone, ricin takes 1-2 granules.

Procedure:

1. Obtain some castor beans from a garden supply store.
2. Put about 2 ounces of hot water into a glass jar and add a teaspoon full of lye. Mix it thoroughly.
3. Wait for the lye/water mixture to cool
4. Place 2 ounces of the beans into the liquid and let them soak for one hour.
5. Pour out the liquid being careful not to get any on exposed skin.
6. Rinse the beans off with cool water and then remove the outer husks with tweezers.
7. Put the bean pulp into a blender or coffee grinder with 4 ounces of acetone for every 1 oz. of beans.
8. Blend the pulp/acetone until it looks like milk.
9. Place the milky substance in a glass jar with an airtight lid for three days.
10. At the end of three days shake the jar to remix everything that's started to settle then pour it into a coffee filter. Discard the liquid.
11. When no more liquid is dripping through the filter, squeeze the last of the acetone out of it without losing any of the bean pulp.
12. Spread the filter out on a pan covered with newspaper and let it dry stand until it is dry.
13. The final product must be as free of acetone and other contaminants as possible. If it is not powdery but still sort of moist and pulpy it must be combined with the appropriate amount of acetone again and let sit for one day.
14. Then repeat steps 9-12 again until a nice dry powder is produced.

(Breivik manuscript ends).

Potassium Cyanide

Potassium cyanide is a potent cellular poison that can be used as is or in the manufacture of hydrogen cyanide gas or poison-tipped bullets. As a rule, always wear appropriate protective gear when making and handling cyanide products.

- Potassium carbonate.
- Potassium ferrocyanide.
- Crucible.
- Furnace.
- Tongs or long-handled pliers.
- Iron pan, etc.

- Hypo solution. Can be found in photography stores.
- Sodium nitrate. I, No. 18 is not acceptable.
- Hypodermic needle.
- Jar.



Procedure:

1. Ignite the furnace.
2. Place 8 parts by weight of potassium ferrocyanide in the crucible for 5 minutes without the air supply.
3. Remove the crucible from the furnace and scrape out the ferrocyanide.
4. Repeat steps 2 and 3 with 3 parts by weight potassium carbonate. Mix the ferrocyanide with the carbonate.

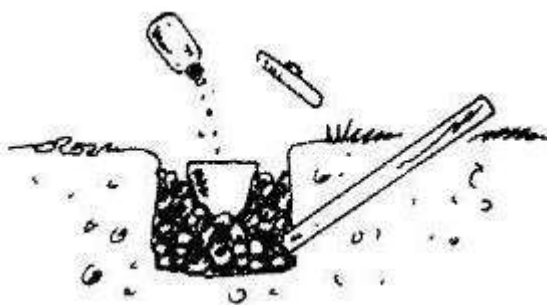

5. Put the crucible in the furnace, put the cover on, and start up the air supply. After about 10 minutes, remove the cover with tongs and add the ferrocyanide/carbonate mixture. Soon the powders will melt and then start to boil.

CAUTION: At this point the potassium cyanide is produced. Be very careful when handling the materials that come in contact with the cyanide. If any come in contact with skin, immediately wash away with lots of water. You should be wearing the appropriate gear!

6. As soon as the bubbling stops after the gases have been driven off, remove the crucible from the furnace with tongs and pour the clear liquid only onto the cool iron pan.
7. Pulverize the white mass that crystallizes on the pan and place in a jar for storage.

Note: In order to make tablets of potassium cyanide, add just enough Elmer's glue to the desired amount of powder to moisten it. Next, press it into a mold, such as a ring of 5/8-inch copper tubing, and let the glue dry.

Hydrogen Cyanide

Hydrogen cyanide is an extremely poisonous gas. A small amount of this gas can incapacitate or kill anyone breathing it. Remember that hydrogen cyanide is heavier than

air, and will sink. Once potassium cyanide has been acquired, it is very easy to produce. All that is needed is potassium cyanide and concentrated sulfuric acid. Sulfuric acid can be concentrated by boiling it for a while so that the other stuff evaporates. Pour sulfuric acid on potassium cyanide and hydrogen cyanide is produced. A truck could be used to spread this gas around, as was done by the Aum Shinrikyo in Matsumoto, although they used sarin. Sarin is more poisonous but requires a proper laboratory and extremely rare chemicals to produce. Aum Shinrikyo had connections to the upper class of Japan and managed to get the chemicals that way.

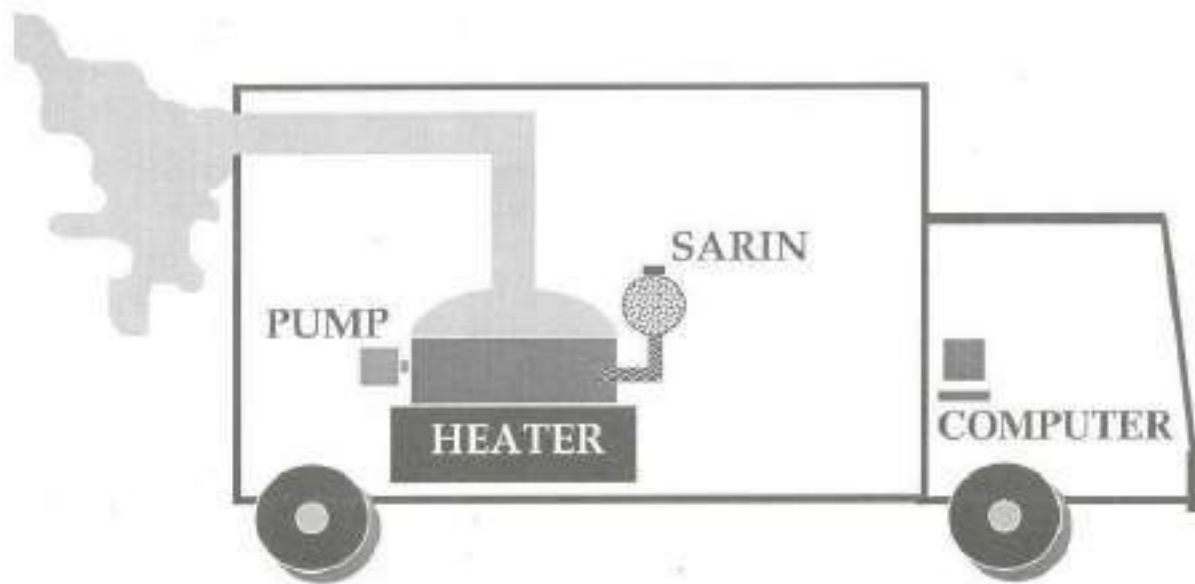

Using this contraption, they killed 8 people and injured 500.

Cyanide Antidote

In case of cyanide poisoning, give the victim an injection of 10 mL 25% hypo (sodium thiosulfate) solution and 10 mL water in which 1 teaspoon sodium nitrate has been dissolved. If possible, get victim medical attention as soon as possible.

Chlorine Gas

Chlorine is a gas that is very toxic in high amounts. It has a sickly green colour and a distinctive smell, recognizable to many at low concentrations as 'the smell of pool centers' due to its compounds use as a water disinfecting agent. Elemental chlorine is extremely toxic and corrosive to many common metals. Because it is heavier than air, it tends to accumulate at the bottom of poorly ventilated spaces. Chlorine gas is a strong oxidizer, which may react with flammable materials. It is notorious for reacting with iron at high temperatures, in a strong exothermic reaction, known as chlorine-iron fire.

Liquefied chlorine must be stored in cold places, away from any source of heat. Chlorine can be liquefied at room temperature, at a pressure of 7.4 bar. Chlorine releasing chemicals, such as bleach and TCCA should be stored in closed bottles, usually covered with a bag or in a box, that must be opened from time to time to release the pressure. The

storage area for both chemicals should not contain any metal parts susceptible to chlorine attack.

There are many methods to generating chlorine gas.

A hypochlorite and hydrochloric acid will produce chlorine; either a solution of sodium hypochlorite or calcium hypochlorite. A violent reaction with a lot of foam may take place in the case of the latter, and starting small scale is a must to get a sense for the reaction before any large scale chlorine production is attempted.

A popular way of making chlorine is using hydrochloric acid and trichloroisocyanuric acid (TCCA). TCCA can be found as slow release chlorine tablets for swimming pools. This reaction is favorable because it not too expensive, produces a large amount of chlorine over an extended period of time (while hypochlorites tend to violently produce all the chlorine right on mixing with the acid), leaves no awful byproducts (such as MnO_2) and the reaction speed at standard concentrations and temperatures is not too fast nor too slow for most applications.

Gas Masks

Many people buy a gas mask to keep around, to prepare for possible gas attacks. However, there's a lot of misinformation about gas masks, and purchasing and wearing a surplus gas mask without doing your research can result in serious medical issues like lung cancer.

Old gas masks were made with carcinogenic materials like asbestos. Don't just buy any old surplus mask that looks cool and breathe through it – you could be putting yourself at risk of lung cancer from inhaling unseen debris. Instead, research the specific model of mask before you put it on. The older the gas mask, the more likely this will be a problem.

However, if you're looking for legitimate protection against a gas attack, you need to do further research.

First of all, old military surplus filters won't be good enough. The chemicals in gas mask filters degrade over time. Whatever mask you purchase, make sure it's compatible with 40 millimeter NATO standard filters. Many people will tell you that you must buy a modern, brand new mask for \$200+, but a surplus mask should do the job as long as it accepts 40mm filters. If you're trying to seriously prepare, stock up on new filters and keep them in sealed packages.

If you're going to wear your mask to a protest or riot where tear gas is a threat, remember that tear gas is actually a very fine particulate, and a regular filter won't perform well against it. Make sure you purchase a filter with a P-100 rating – the highest for filtering out particulate. You can also purchase P-100 rated prefilters that clip over the actual filter.



Anders Breivik in gas mask and hazmat suit.

Also remember that a gas mask alone is not enough to survive a chemical attack. The point of a gas mask is just an emergency lifesaving device to allow you to escape the gas. Many chemical weapons can either blister the skin or be absorbed through it. If you're intentionally or knowingly going to be exposed to a chemical threat, you need a full-on chemical suit and the training to use it correctly.

Kidnapping Drugs

Drugs are very useful when not taken by the guerrillas, as they can be used to kidnap targets. The guerrillas should not take drugs. Most of these drugs are used by rapists to incapacitate people so that they can rape them. Put the drugs in the food or drink of the target to affect them. Ensure that the target is unaware that the food or drink is contaminated. Do not use the wrong dose. Overdosing the food or drink may kill the target, which could be the desired goal in some situations. Some drugs that can be used for kidnapping are illegal, while others can be bought from pharmacies. All of these can be orally administered. The lethal dose of these drugs can be found with a simple search on the internet.

Drugs	Legality
Anti-psychootics.	Legal.
Chloral hydrate.	Legal.
Flunitrazepam.	Legal.
GHB.	Legal.
LSD.	Illegal.
MDMA.	Illegal.
Methaqualone.	Illegal.
Phencyclidine.	Illegal.
Scopolamine.	Illegal.
Xanax.	Legal.
Zopiclone.	Legal.
Zolpidem.	Legal.



CHAPTER XV: Vehicles

Vehicle Security

Note: This section was largely written by Ronald Eriksen. The guide was written in 1983.

The maneuvers in this book can be done in just about any car. The only cars which are completely unsuitable are jeep-type vehicles. Although fine for going off the road, jeeps have a tendency to tip over during turns.

The ideal vehicle is one that is powerful, easy to handle, and above all else, reliable. I have found that German-made cars are among the best in these respects. The only recently made German car that is under par is the Volkswagen "Rabbit" which is just too small and underpowered. Although there are some notable exceptions, American and Japanese cars are not well known for their handling and performance qualities. They are made to give a soft cushy ride and little else. If you have to buy one of these, try to avoid both the small economy types and the oversized rolling boats, such as the larger Buicks and Oldsmobiles. Also to be avoided are exotic European cars such as Ferraris and Lotuses. Although they are a true pleasure to drive, the fact that they stand out so much makes them a prime target for an attack.

Listed below are modifications which will enhance both the performance and reliability of a vehicle. Also listed are modifications which will serve as deterrents to an attack.

Tires: Get the best radial tires you can afford. Radials offer increased durability, superior handling, and better gas mileage than old-fashioned bias ply tires. Also, to some degree, radials are bullet resistant. Be sure to slightly over inflate all four tires and to fill them with run flat foam (available in auto supply and department stores).

Heavy Duty Radiator: Hard driving, hot weather and rough terrain make for overheated engines. A heavy duty radiator helps prevent this from happening.

Heavy Duty Shocks and Springs: Other than good tires, nothing will improve your car's handling more than top quality shocks and springs. Shocks and springs are items where price is an indication of quality, so get the best you can afford.

Stainless Steel Brake Lines: Rubber brake lines sometimes swell and flex, causing the brakes to fade. Stainless steel brake lines are used in racing competition and are recommended particularly to those living in mountainous areas.

Heavy Duty Steering Pump: If your car has power steering, a series of quick turns might cause the steering fluid to foam, making steering extremely difficult. A heavy duty steering pump serves to prevent this.

Heavy Duty Battery: If you are going to add additional lights and communications gear to your car, a heavy duty battery is a must.

Lights: You should replace your old-fashioned sealed beam headlights with quartz-iodine lights. These give off twice the light of the sealed beam units and will enable you to drive much faster at night. There are quartz-iodine lights to fit almost every vehicle. You might also consider mounting additional lights on your vehicle. Auxiliary lights should be mounted low and angled slightly outward.

Spotlights: Four high intensity spotlights should be mounted high on your vehicle. These will effectively blind an attacker. Three of the spotlights should be directed to the front, one aiming straight ahead and the other two angled slightly outboard. A fourth light should be aimed to the rear.

Cut Out Switches: Cut out switches enable you to independently control each light on your vehicle. The addition or elimination of various lights at night will alter the appearance of your vehicle and might allow you to lose a pursuer.

Vehicle Alarm System: A good alarm system should not only guard against theft, but also against tampering. "Consumer" type publications often rate the various alarm systems and you should consider their advice before buying one.

Armor: There are many problems involved in the armoring of vehicles, not the least of which is cost. A bargain basement armoring job, offering some protection against a .30 caliber rifle will cost you about \$20,000. A fully armored vehicle capable of withstanding repeated hits from a .30 caliber rifle will run you about \$200,000. Most of us don't have that kind of money lying around.

Another problem with armoring is that there is no such thing as bullet proof glass. There is only "bullet resistant" glass. We saw how effective this glass was during the attempted assassination of President Reagan. During the attack, a round from the assailant's lowly .22 pistol penetrated the glass on the presidential vehicle.

Yet another problem associated with armoring is the weight added to the vehicle. A 25% increase in vehicle weight will cause a corresponding decrease in the vehicle's handling capabilities.

If you can't afford the high cost of a full armor job, then I suggest that you affix a half-inch aluminum plate to the back of each seat. For most of the evasive maneuvers in this book, the only clear shot a bandit or terrorist will have is at the rear of your vehicle. While the half-inch plate won't protect you against all weapons, it does offer inexpensive protection against submachine guns and pistols.

Good Mirrors: Either wide angled or electronically controlled mirrors will allow you to see what is going on behind you without turning your head.

Locking Gas Cap: A locking gas cap prevents anyone from using the gas tank as a receptacle for explosives. It will also prevent Halloween pranksters from putting unwanted items in the tank.

Gun and Crowbar in Trunk: Kidnappers have been known to throw the victim into the trunk of his own car. A gun and a prying instrument such as a crowbar could prove useful in an escape.

Pressurized Oil Slick: A pressurized device which sprays oil onto the roadway will eliminate almost any pursuer.

Caltrops: Caltrops are metal spikes constructed so that one point is always up. If thrown in the road behind you, they will flatten the tires of a pursuing vehicle. One company who sells them is Beaver Products, PO Box 1580, Anna Maria, FL 33501.

Thick Bolt Through Tailpipe: A thick heavy bolt put through the tailpipe and welded into place will prevent a bomb from being placed in the exhaust system.

Smoke Screen: A cheap but effective smoke screen can be made as follows: First drill a hole into the exhaust manifold of your car, and weld the nozzle of a small plant sprayer over it. A gas line is then run from the nozzle to a pump and container containing castor oil inside the vehicle. Clouds of smoke are produced by pumping the castor oil onto the hot exhaust manifold.

In a recent Chicago bank robbery, the bandits fabricated a smoke screen by filling a fire extinguisher with some chemical. What the chemical was and how they shot it out of the vehicle, I don't know. I do know that in addition to the considerable smoke, a noxious odor was also produced.

Reinforced Ram Bumpers: Bumpers can be reinforced by bolting or welding extra supports from the vehicle frame to the bumper. Further reinforcement can be made by welding a two-inch metal pipe to the vehicle frame, right in back of the bumper. These extra reinforcements could prove useful in a ramming situation.

Survival and First Aid Kit: A good emergency survival kit, including an extra jack, and a first aid kit should be in every vehicle.

Getaway Driving

Both terrorists and everyday street criminals operate in a fashion similar to predatory animals – they will always choose the weakest prey or the easiest mark to attack. By being security conscious at all times, you can increase the odds that they will choose someone else.

What follows are some general security recommendations which can be easily implemented when in or around your vehicle. These recommendations will be your first line of defense against an attack.

- (1) Vary the times and routes to and from work. Avoid fixed routines.
- (2) Have thorough knowledge of the area you are driving in.
- (3) Avoid getting boxed-in in traffic.
- (4) Always park so you have a fast exit from your parking space.
- (5) Never stop for anyone.
- (6) Drive on major thoroughfares, if possible.

- (7) Know the shortest routes to police stations, hospitals, army outposts, etc.
- (8) Check rear-view mirrors frequently.
- (9) Inform someone of your destination and estimated time of arrival.
- (10) Be wary of groups of men in uniform (jogging suits, janitor outfits, etc.).
- (11) Never trust anyone with your key.
- (12) Avoid construction areas.
- (13) Keep your gas tank at least half full.
- (14) Never depend on a chauffer. Drive yourself.
- (15) If your car has been left alone, check it thoroughly for tampering before driving it.
- (16) If suspicious people are observed loitering about your vehicle, avoid it.
- (17) Maintain a low profile.

Surveillance examples

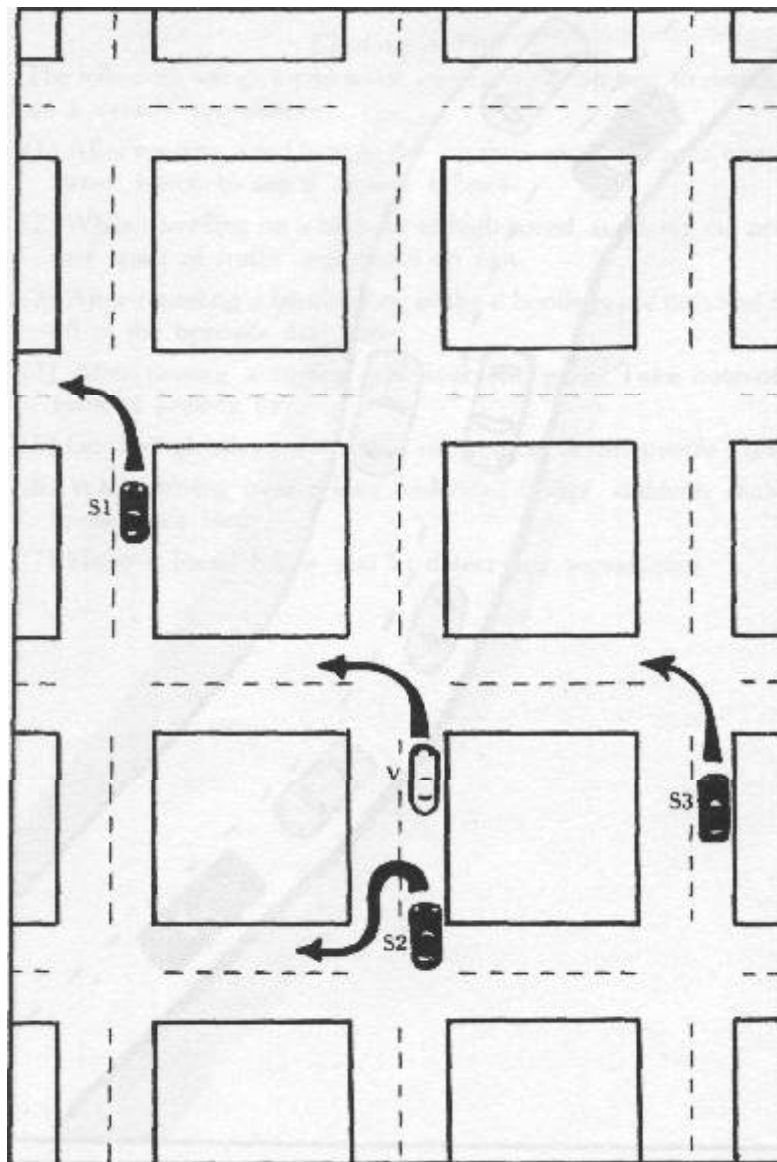

Figure 1
Parallel Surveillance in action
After victim (V) turns, S3 turns after him. S1 and S2 follow on parallel streets.

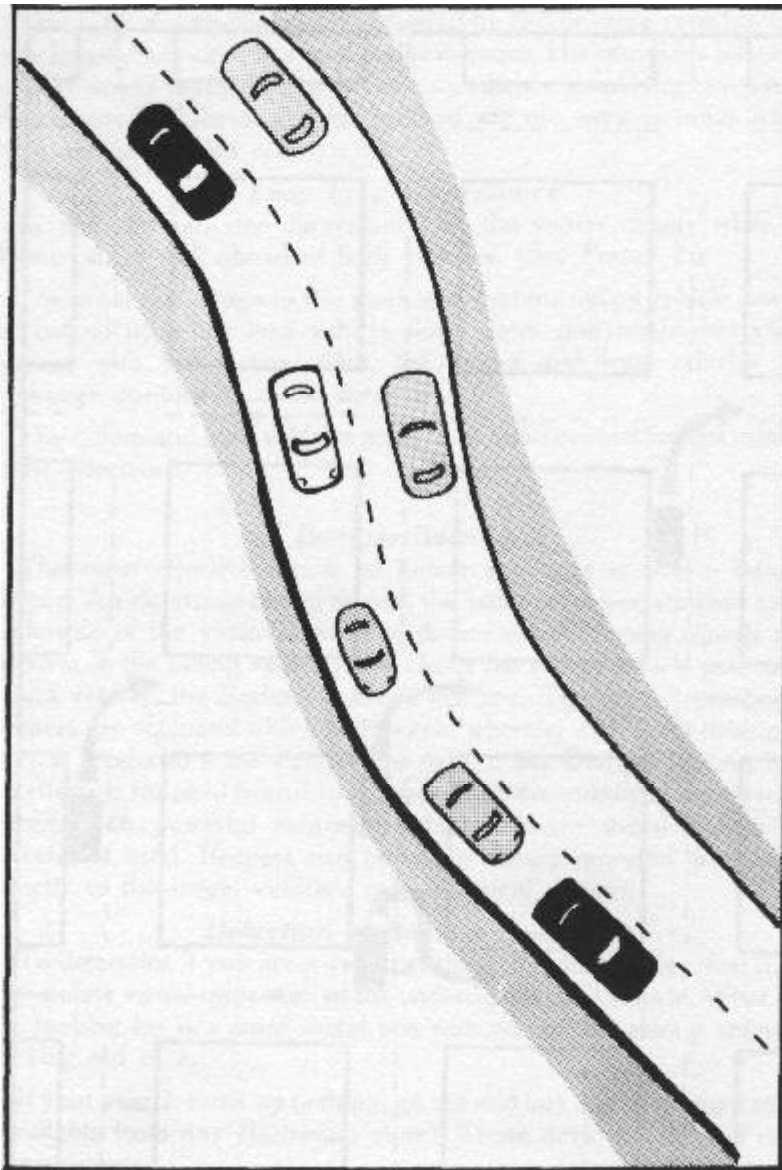

Figure 2
Leap Frog Surveillance
Victim is in white car; surveillants in black cars.
Surveillance vehicles can switch positions to avoid detection.

With field strength meter in hand and the vehicle's ignition on, check in, on, and especially under, your car. If you are a victim of a bumper beeper, the meter will tell you where it is.

The following will give you some general ideas on how to detect and elude vehicle surveillance.

- (1) After running a red light or driving the wrong way on a one-way street, watch to see if anyone follows.
- (2) While traveling on a freeway at high speed, suddenly cut across four lanes of traffic and make an exit.
- (3) After rounding a blind curve, make a bootlegger's turn and take off in the opposite direction.
- (4) After turning a corner, pull over and park. Take note of all vehicles passing by.

- (5) Go through alleys, dirt roads, or even cut across people's lawns.
- (6) While driving over a long undivided bridge, suddenly make a bootlegger's turn.
- (7) Have a friend follow you to detect any surveillance.

Cornering

It is a commonly held belief that the best way to handle corners is to blast through them as quickly as possible. This is completely wrong. The speed at which you exit a corner is much more important than the speed at which you take the corner itself. Assuming identical cars, the car which exits the corner at the greater speed will be going faster on any straight stretch of road that follows.

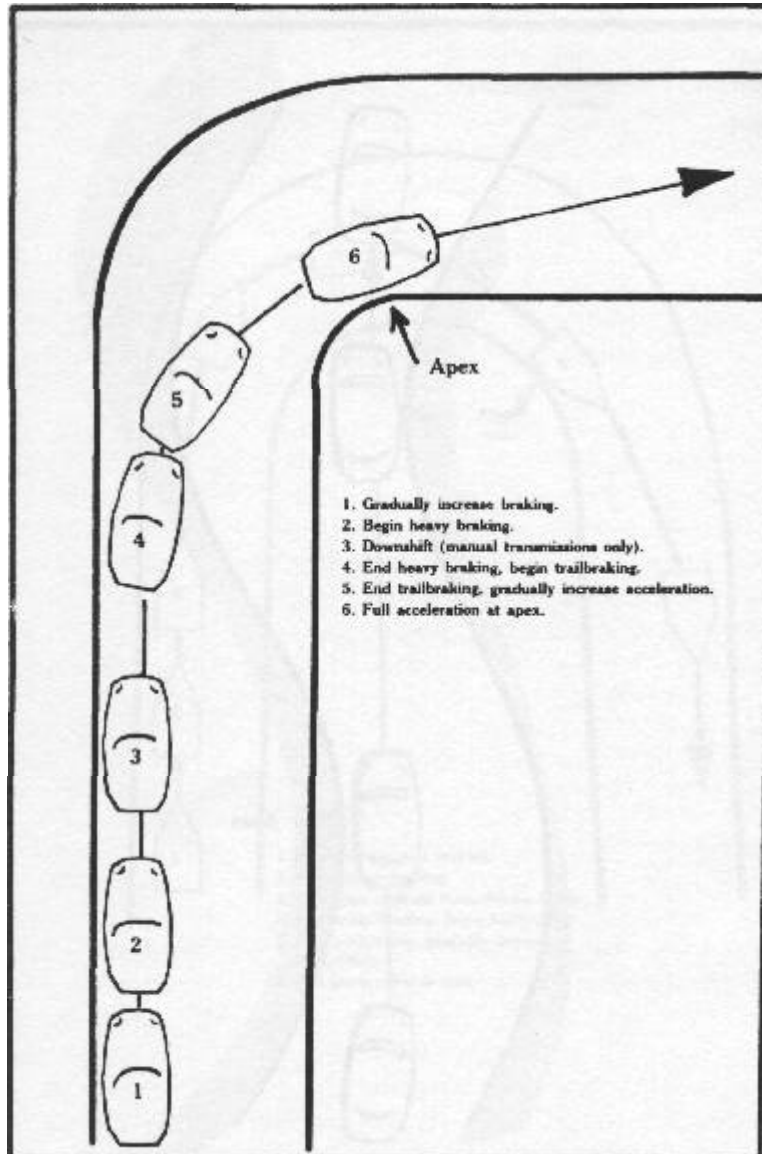

Figure 3
Taking a 90-degree turn

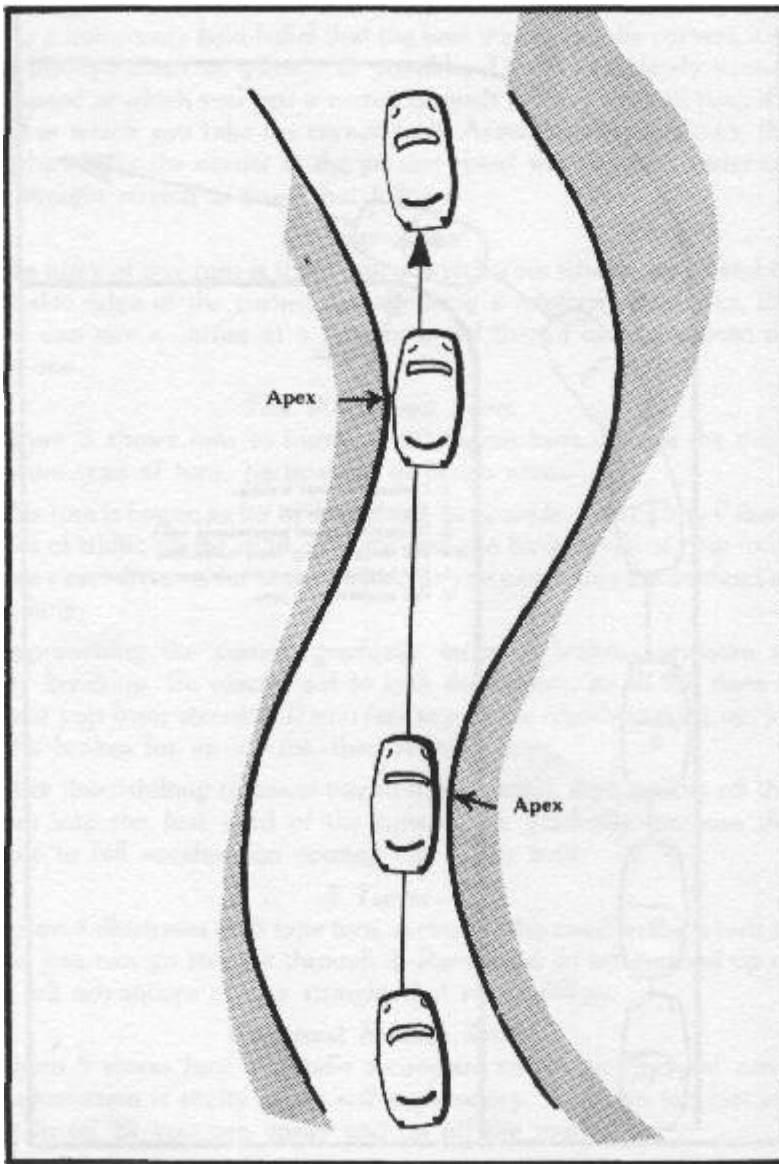

Figure 4
S Turn

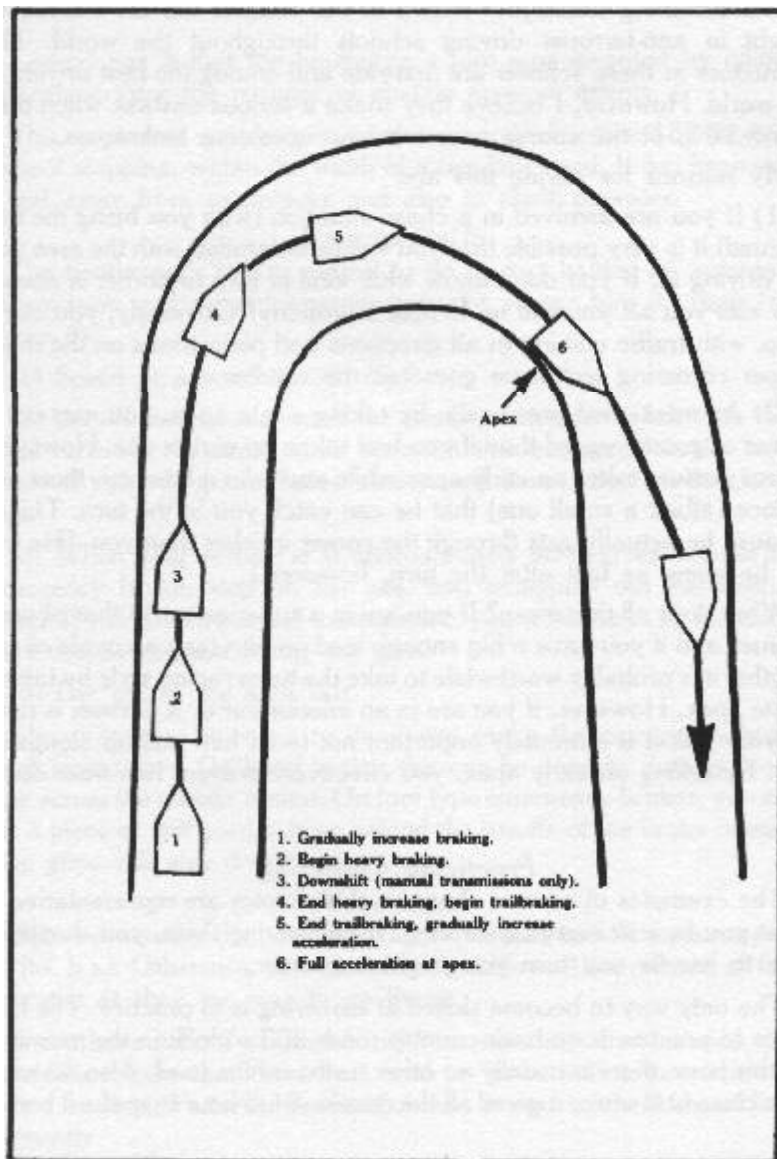

Figure 5
Constant Radius Turn

The cornering techniques shown in this chapter are the techniques taught in anti-terrorist driving schools throughout the world. The instructors at these schools are first-rate and among the best drivers in the world. However, I believe they make a serious mistake when they spend 70% of the course time teaching cornering techniques.

The only way to become skilled at cornering is to practice. The best place to practice is on back country roads at 3 o'clock in the morning. At this hour, there is usually no other traffic on the road. Also, as most bars close at 2 a.m., it gives all the drunks a full hour to make it home.

Now some maneuvers.

Bootlegger's turn

The bootlegger's turn is easiest to do in cars having an automatic transmission and a hand emergency brake. Here's how it's done (see Figure 6):

- (1) Speed at around 25-30 mph.
- (2) Get off the gas and crank the steering wheel to the left $\frac{1}{4}$ to $\frac{1}{2}$ of a full turn. At the exact same time, hit the emergency brake hard. Those of you with manual transmissions will have to depress the clutch, also.
- (3) When your vehicle is at approximately 90 degrees, release the emergency brake, step on the gas, and straighten out the steering wheel. If you have a manual transmission, you will have to let the clutch back out as you are hitting the gas.
- (4) Get out of the area fast.

Before practicing the bootlegger's turn, be sure to inflate your tires to 40 lbs psi. Otherwise, the sidewalls might blow. Also, remove all four hubcaps, as they are sure to go flying. Be aware that cars with transmissions tend to "puke out" transmission oil during bootlegger's turns.

Figure 6
Bootlegger's
Turn

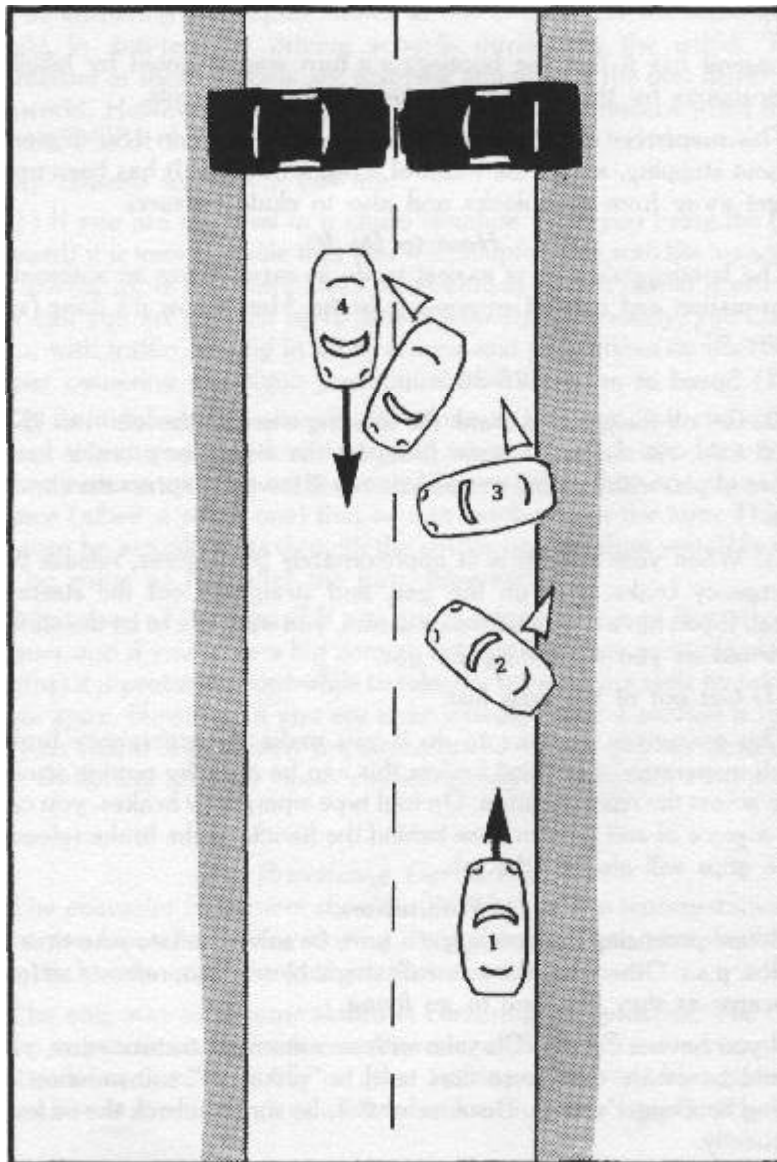

Moonshiner's turn (reverse 180)

Looking like a bootlegger turn in reverse, the moonshiner's turn allows you to change your direction 180 degrees within the confines of a two lane road, while going backwards.

- (1) Accelerate in reverse to 20-30 mph.
- (2) Get off the gas and crank the steering wheel all the way to the left as fast as you can.
- (3) When the car is at 90 degrees, shift into low gear, hit the gas, and straighten out the steering wheel.
- (4) Get out of the area fast.

This maneuver is particularly effective against roadblocks at night. Often the attackers manning the roadblock will use high-intensity lights to blind the victim as he approaches. By using the moonshiner's turn, the victim's vision is directed away from the lights.

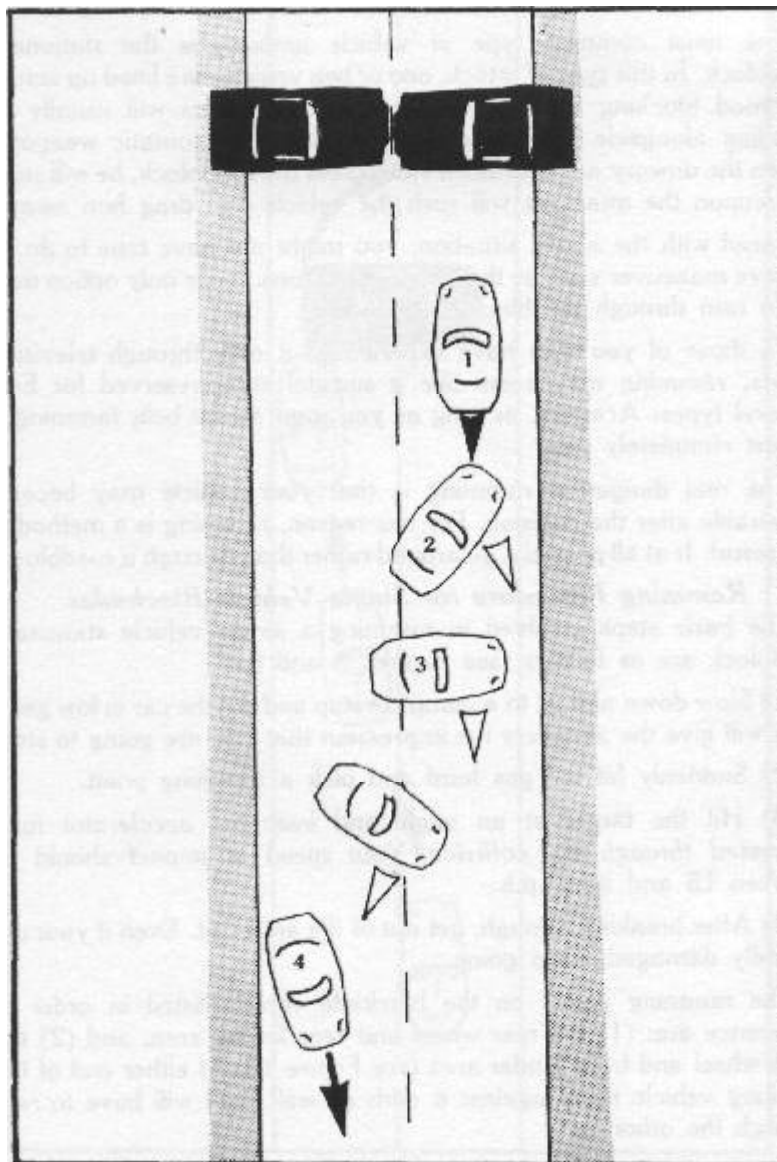

Figure 7
Moonshiner's
Turn

Ramming

The most common type of vehicle ambush is the stationary roadblock. In this type of attack, one or two vehicles are lined up across the road blocking the victim's way. The attackers will usually be standing alongside the blockade vehicles with automatic weapons. When the unwary and untrained victim sees the roadblock, he will stop, whereupon the attackers will rush the vehicle and drag him away.

Faced with the above situation, you might not have time to do an evasive maneuver such as the bootlegger's turn. Your only option may be to ram through the blockade vehicle(s). To those of you who have experienced it only through television shows, ramming may seem like a suicidal stunt reserved for Evel Knievel types. Actually, as long as you wear a seat belt, ramming is almost completely safe.

The real danger in ramming is that your vehicle may become inoperable after the collision. For this reason, ramming is a method of last resort. If at all possible, go around rather than through a roadblock.

The basic steps involved in ramming a single vehicle stationary roadblock are as follows (see Figures 8 and 9):

- (1) Slow down almost to a complete stop and put the car in low gear. This will give the attackers the impression that you are going to stop.
- (2) Suddenly hit the gas hard and pick a ramming point.
- (3) Hit the target at an angle and keep the accelerator fully depressed through the collision. Your speed at impact should be between 15 and 30 mph.
- (4) After breaking through, get out of the area fast. Even if your car is badly damaged, keep going.

The ramming points on the blockade vehicle listed in order of preference are: (1) the rear wheel and rear fender area; and (2) the front wheel and front fender area (see Figure 10). If either end of the blocking vehicle is up against a curb or wall, you will have to ram through the other end.

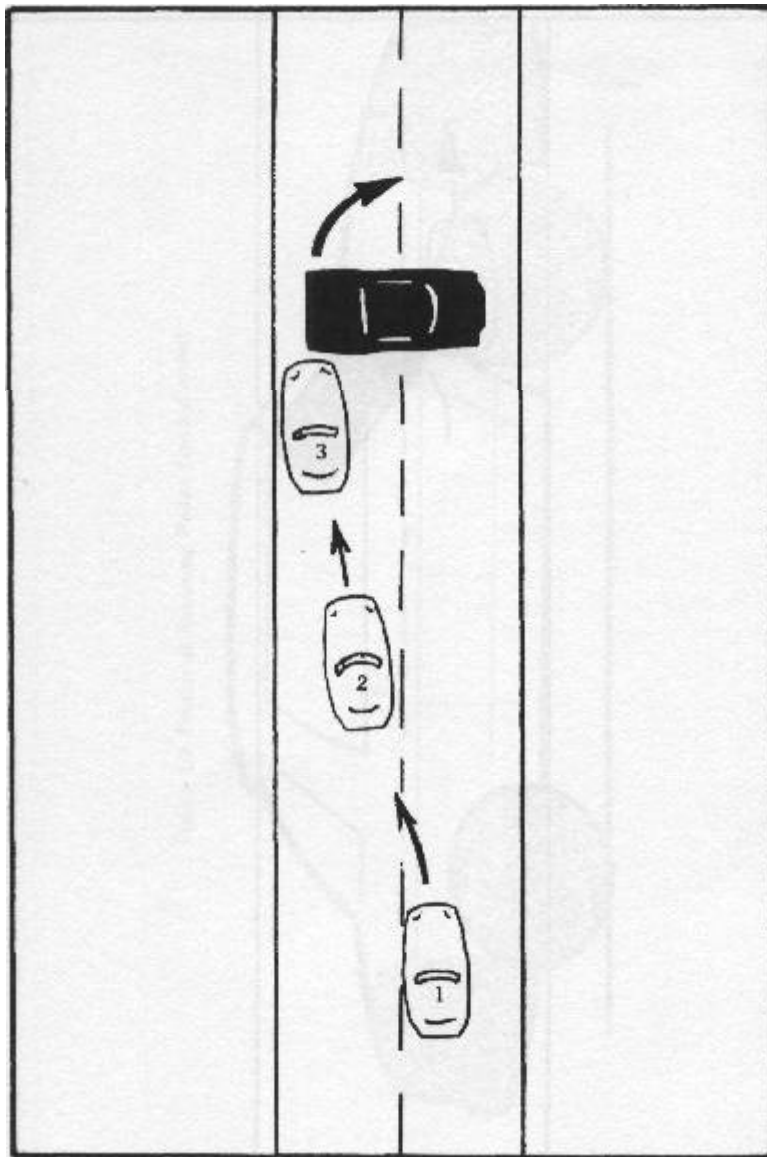

Figure 8
Ramming a Single Vehicle Blockade

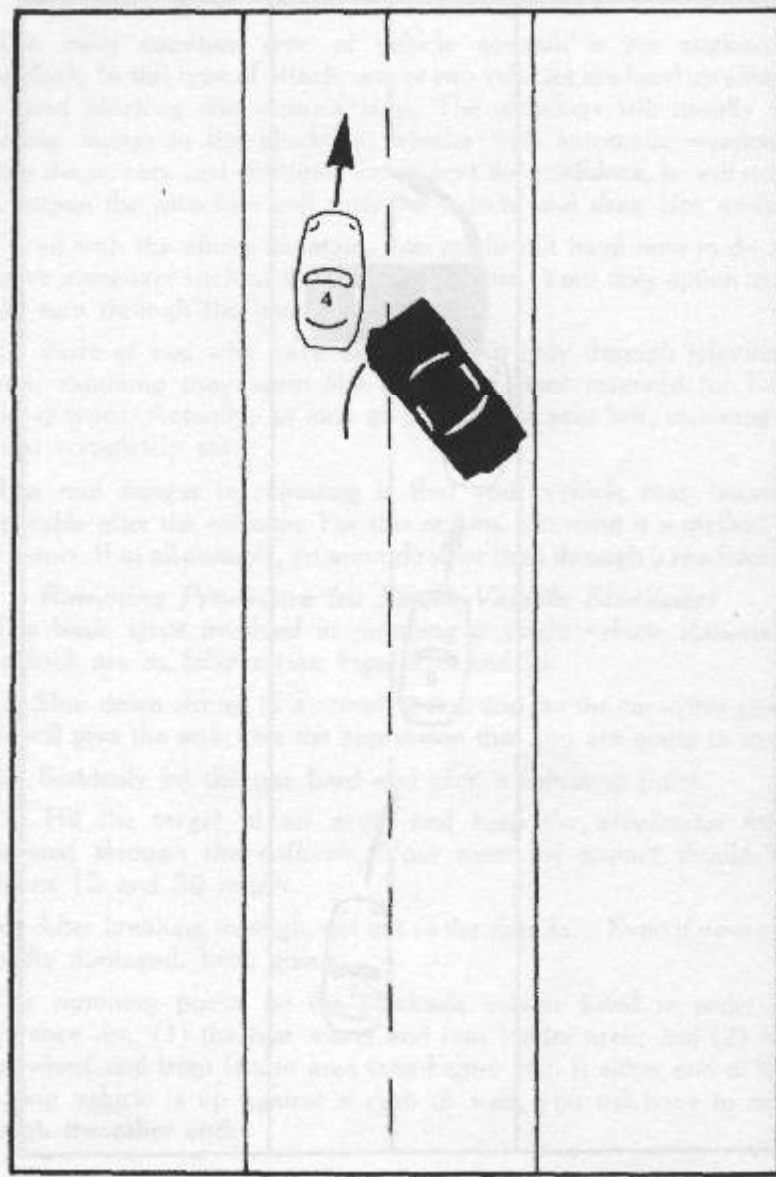

Figure 9
Ramming a Single Vehicle Blockade (cont'd)

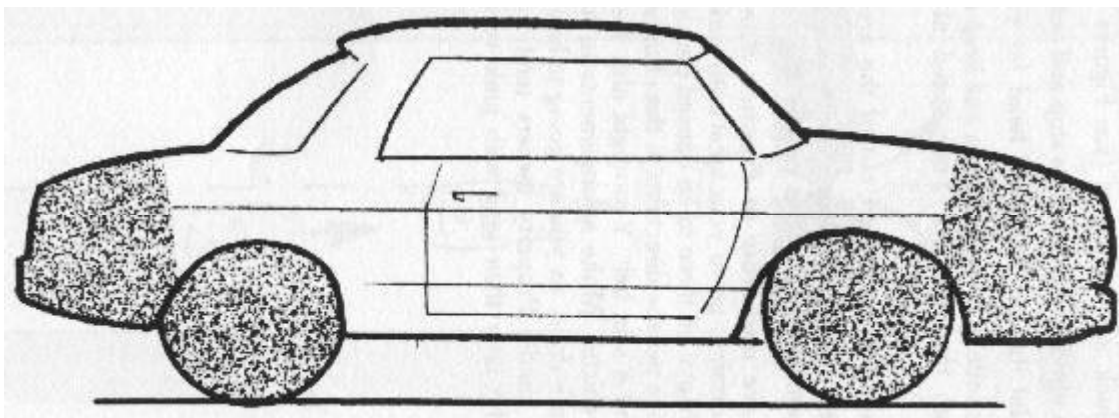

Figure 10: Preferred Ramming Points (shaded areas)

Ramming Procedure: Double Vehicle Blockade

See Figures 11 and 12:

- (1) Slow down almost to a complete stop and put the car in low gear.
- (2) Suddenly hit the gas hard and head for your ramming point.
- (3) Hit the blockade right in the middle and keep the accelerator fully depressed through the collision. Your speed at impact should be between 15 and 30 mph.
- (4) After breaking through, get out of the area fast.

If any of the attackers should be so foolish as to get in your way, run them over.

To practice ramming, go to your local auto junkyard and buy three running wrecks. Move all three to an unused parking lot or abandoned airfield and practice per the directions in this chapter. For safety's sake, wear a helmet and a seat belt. You might also want to remove all the glass from the vehicles. Make arrangements to have the cars towed away when you are done, as you are going to have three non-running wrecks on your hands. Property owners tend to have bad feelings towards those who litter their land with junk vehicles.

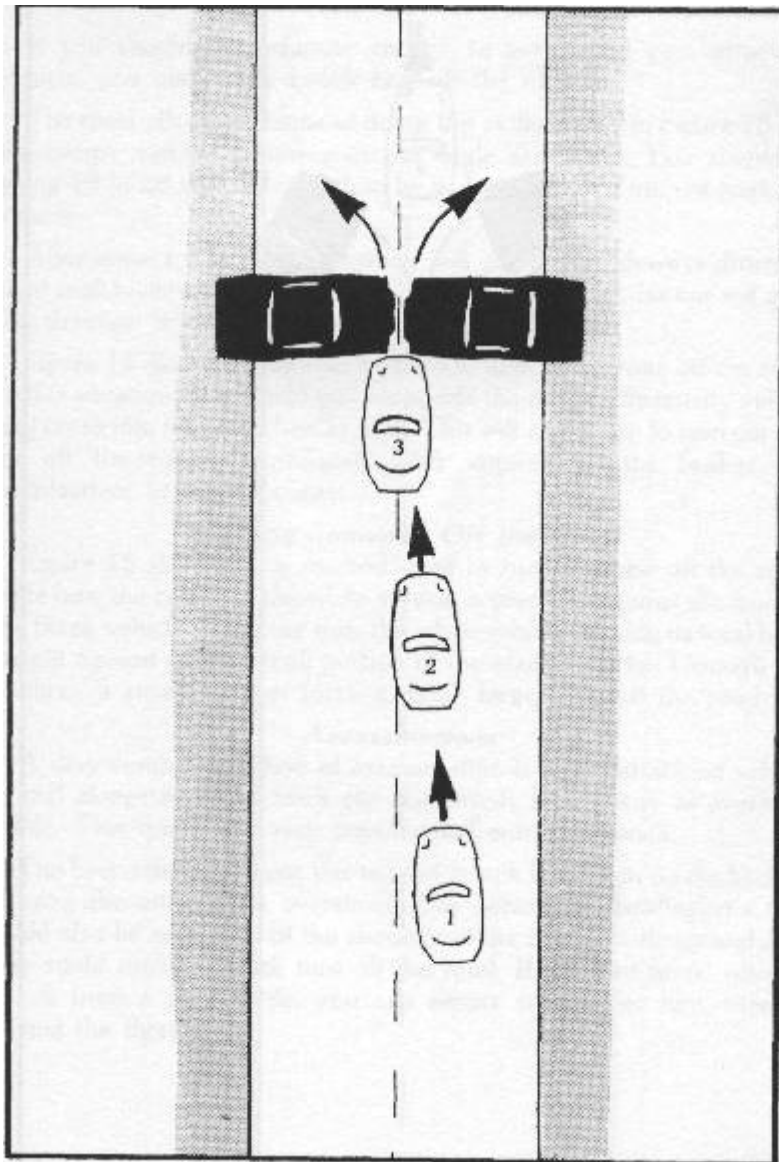

Figure 11
Ramming a Double Vehicle Blockade

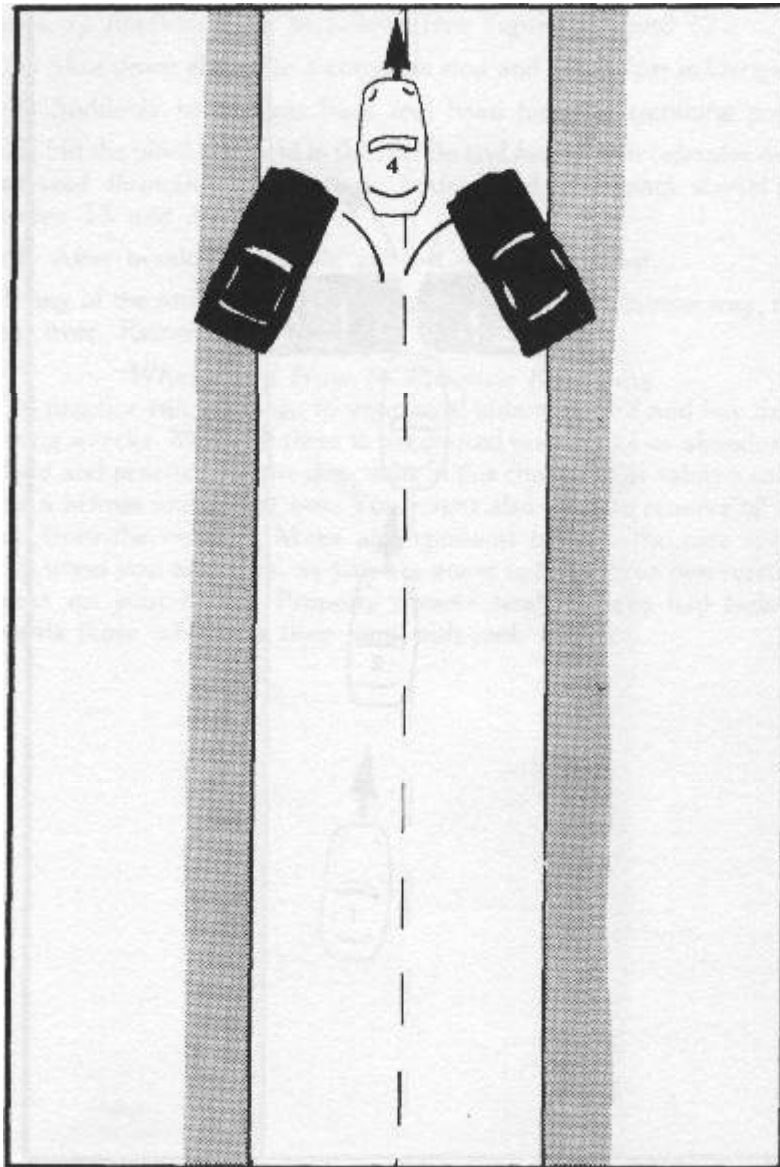

Figure 12
Ramming a Double Vehicle Blockade (cont'd)

Vehicle attack

If you should be fortunate enough to get behind your attacker's vehicle, you can easily knock him off the road. The most effective means of doing this is illustrated in Figure 13. Hit the enemy vehicle's bumper at the angle illustrated. You should be going 10 to 20 mph faster than he is. Remember to hit, not push, the vehicle.

After impact, the enemy's vehicle will go sliding sideways down the road until his tires regain traction. When this happens, his car will go in the direction it is pointing -- off the road.

Figure 14 illustrates another method to knock someone off the road. In this situation, you would pull alongside the rear of the enemy vehicle and crash into his rear wheel section. This will cause him to spin out and go off the road. Immediately after impact, hit the brakes and counter steer to break contact.

Figure 15 illustrates a method used to run someone off the road. Note how the center of the white vehicle is pressing against the front of the black vehicle. By doing this, the white vehicle is using its total body weight against only a small portion of the black vehicle. Through this method, a small car can force a much larger one off the road.

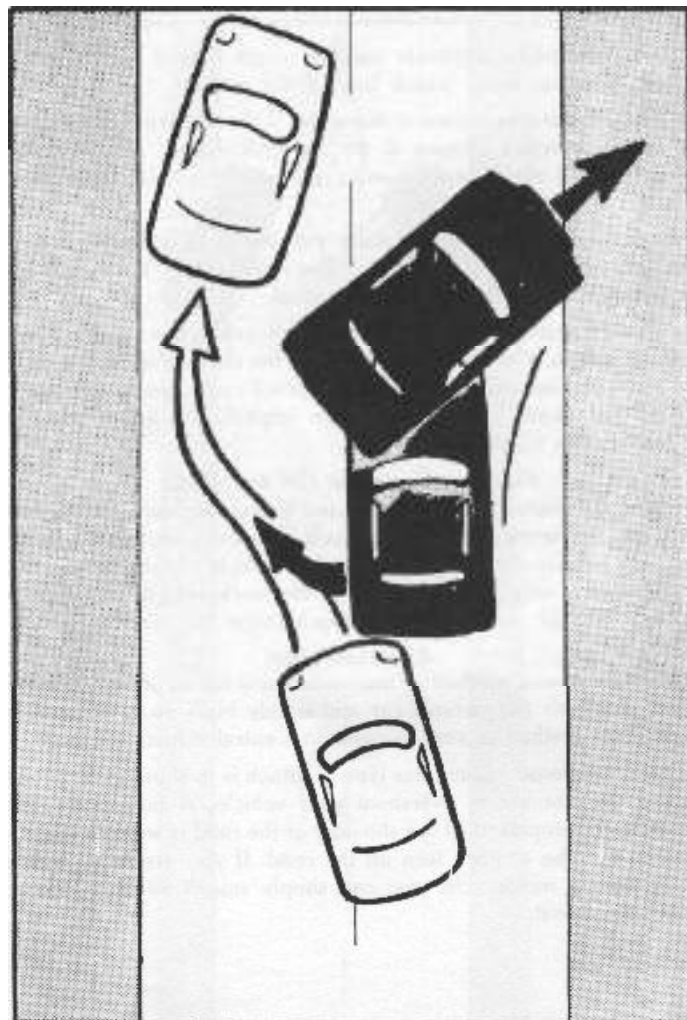

Figure 13
Knocking a Vehicle
off the Road

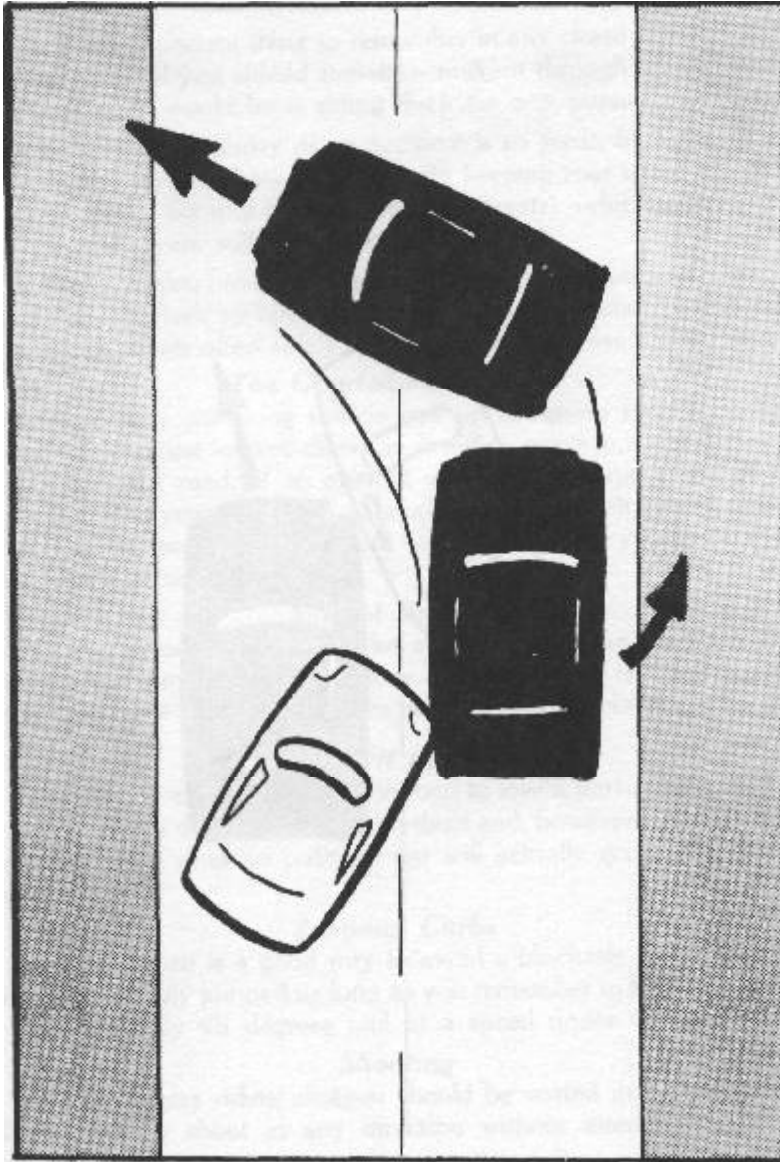

Figure 14
Another Method of Knocking a Vehicle off the Road

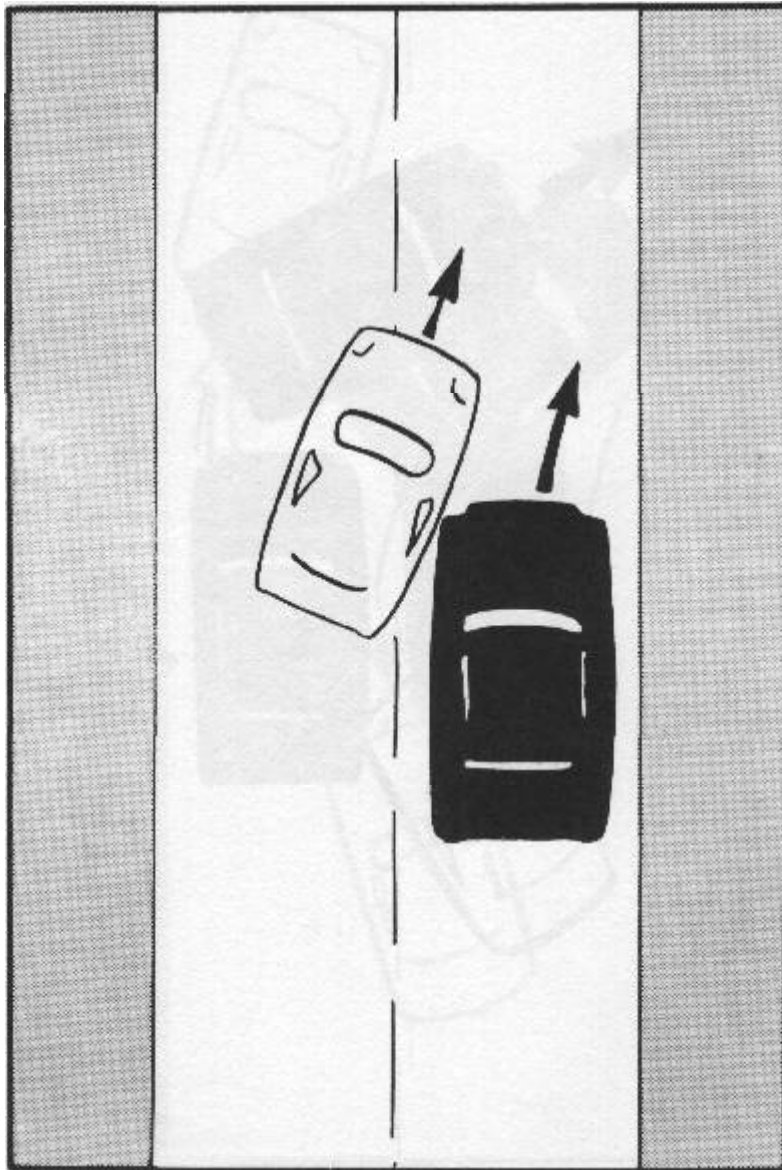

Figure 15
Running someone off the road

Chase situations

The most important thing to remember in any chase situation is not to crash. Even if you should somehow make it through an accident in one piece, you would be a sitting duck for any pursuer. Because the probability of an accident is so great, high speeds are not recommended in chase situations. By keeping your speed relatively low, say under 65 mph, you will have greater vehicle control and evasive maneuvers will be easier to accomplish. Of course, if you have a superior car to that of your pursuer, you can just flat outrun him on open roads. On certain stretches of interstate highway, you can often safely run at speeds in excess of 100 mph.

Never let any attacking vehicle pull up alongside you. If he does manage to position himself there, he is either going to shoot, or try to run you off the road. If an attempt is made to overtake you, it will probably be on your left side. To make this more difficult, drive

as far to the left as you possibly can. Should he try to overtake you anyway, try to swerve in front of him.

It may be necessary to go off the road to lose a pursuer. Be sure not to get stuck in a ditch or drive into a dead end, however. It is surprising how far off the road an ordinary car will actually go, if you drive it carefully.

Jumping a curb is a good way to avoid a blockade in the street. A curb can be easily jumped as long as you remember to hit it at an angle of approximately 45 degrees and at a speed under 45 mph.

Any passengers riding shotgun should be seated in the back. This allows them to shoot in any direction without interfering with the driver. Targets of choice on the enemy vehicle are the driver and the front tires. Obviously, if the driver is incapacitated the chase will not continue. If either front tire goes flat, the attacker won't be able to steer. For best results, try to score a direct hit into the sidewall.

If you absolutely cannot get away from your pursuers, drive your car into a wooded area. When your car won't go any further, get out and get behind cover. If your pursuers are still intent on coming after you, they are going to have to exit their vehicle. When they do, you can ambush them. Never give up when attacked. Violent criminals and terrorists almost always kill their victims. Even those few people who are held hostage and then released usually require some kind of psychological care after their ordeal. Some have even become permanent basket cases.

Ramming Attacks

Note: This section was largely written by Yahya Ibrahim.

In some situations, the resistance will be unable to acquire firearms, explosives, or any proper armory. Then they must use what they have. One of the most reliably destructive weapons that is easily acquired or stolen is a motor-vehicle like a car. For this example, we will be using a pickup truck, as it is the heaviest easily controlled vehicle that is not difficult to acquire.

Pick your location and timing carefully. Go for the most crowded locations of the target. Narrower spots are also better because it gives less chance for the people to run away. Avoid locations where other vehicles may intercept you.

To achieve maximum carnage, you need to pick up as much speed as you can while still retaining good control of your vehicle in order to maximize your inertia and be able to strike as many people as possible in your first run. Keep in mind that as soon as people realize what you are up to, they would scatter and run in every direction looking for cover. They would look for areas where the vehicle cannot reach them. Therefore, it is important to study your path of operation beforehand.

The ideal location is a place where there are a maximum number of targets and the least number of vehicles. In fact if you can get through to "pedestrian only" locations that exist in some downtown (city center) areas, that would be brutal. There are some places that are closed down for vehicles at certain times due to the swarms of people. Politically, it would

be best if the target was status quo-affiliated, such as an army parade, pro-status quo demonstration or a group of politicians.

This is one of many ways to implement this idea. You may modify it and add or subtract to it according to what is suitable for your particular conditions.

Killdozer

On June 4, 2004, Marvin Heemeyer executed an operation against the city Granby, Colorado, with a homemade tank. No one was injured in the attack, but it caused 7 million dollars in damages and destroyed 13 buildings. His truck was able to demolish buildings by driving through them. The attack ended when the tank's tracks broke through the floor of a building and into its basement. Police had to use an oxyacetylene cutting torch to open the tank after attempting and failing to open it with explosives. Seeing how effective it was, we should know how to make one.

- Bulldozer. (The D355A was used by Heemeyer).
- Concrete mix. (34 MPa Quikrete was used by Heemeyer).
- Tool steel sheets.
- Video monitor.
- Video cameras.
- Bulletproof lexan.
- Compressed-air nozzles. • Ventilation.
- Crane.
- Water and food.

Start up a muffler repair shop as a front for buying in concrete mix and tool steel sheets preferable 1 or 2 years earlier. Also buy a bulldozer. Calculate the dimensions of the bulldozer so that the armor will fit. Fit the concrete mix between the tool sheets. Multiple layers of tool sheets are to be used. This is the armor. The armor is to be about 30 cm thick. Shape the composite armor with the armor and measurements of the bulldozer. The composite armor should cover the cabin, the engine, the radiator and parts of the tracks. There is to be no way in and no way out when the composite armor is put on the bulldozer. The composite armor is put on the bulldozer with the crane just before the operation is to be executed.

Connect the video monitor to the video cameras. Place the monitor inside of the bulldozer. Fit the video cameras to the armor. Fit bulletproof lexan around the video cameras. The lexan is to be 7.4 cm thick. Fit compressed-air nozzles under the lexan to blow off dust and debris that will obscure the view of the video camera. Install the ventilation inside of the bulldozer. The ventilation is to be very good since there will be no way out of the bulldozer. The construction process for the killdozer takes multiple months or a year. Sit in the bulldozer and lower the composite armor on the bulldozer with the crane to engage the killdozer. Now, drive through the wall and the operation has begun.



A D355A bulldozer.

Heemeyer's killdozer.

Car Theft

Car theft is a method the guerrilla could use to acquire materials for transportation or car bombings. The guerrilla should avoid stealing cars for economic reasons as the criminal does. Cars can be stolen in multiple ways. Here are a couple techniques.

Stealing keys

The most obvious technique for stealing cars would be to steal the target's car keys. Pick their pockets, execute a robbery on their house, etc. This technique is difficult to execute when the target car's owner is unknown or armed.

Relay method

Many modern cars are opened with radio transmissions now which constantly emits radio signals. This makes the job much easier actually. There was a time when that meant they would have to pick your pocket, mug you in the street, or break into your house to get your key, but none of that is necessary anymore. Now all they need is a simple electronic device that can be bought relatively cheaply on the internet and to be within a certain distance of your key fob. These devices are called relay boxes.

A relay box works by extending the signal coming from the car keys inside the house and tricking the car's system into believing that it's the actual key. The key is too far away to open the car but the relay box will extend the signal. The devices vary in signal range and price, with powerful units fetching hundreds of dollars. Simply steal the signal from the remote car keys and then use them on the car. Remember to consult the manual that comes with the device.

The NICB tested a device on over 35 cars, mini vans, SUVs and a pickup truck over a two-week period last year. The relay attack unit – you can buy these things online – opened 19 out of the 35 cars tested. It started 18 of those 19 cars. With two-thirds of those cars, NICB researchers could not only start the cars and drive them away; they could also turn them off and restart them, as long as they had the device inside. In addition, the Berlin-based

automobile club ADAC in March 2016 released a study in which it reported that thieves could use a \$225 signal booster – in the same ballpark as a relay box – to fool cars into thinking their owners are nearby, allowing them to easily unlock the cars and start them up.

Jammer method

What will be required for this method is a remote jammer, laptop, a key programming device and a blank key. In short: While the driver tries to use the remote key use the jammer to block the signal. You could idle near the vehicle smoking or sitting on a bench. If the driver does not notice and walks away the car will easily be yours. Enter the car. Put in the key programming device in the car's diagnostics port and program the blank key to control the car. Now the car could be reused. This process may take 10 to 15 minutes.

OBD method

This method works for most Fords built after 2001. It requires some knowledge about electronics. The method has to be quickly executed. Smash the window of the target car and get inside. Connect to the OBD port in the car. Use the connection to disable the alarm system and then start the car.

Ignition lock method

Now a method for older cars. This requires breaking the ignition lock of the car. Smash the window of the target car and get inside. The most optimal method is to use a screw, screwdriver and a slide hammer. Put the screw in the ignition and then use the slide hammer to drag out the lock. Then manipulate the ignition lock with the screwdriver. Another method would be to use a strong screwdriver and a strong hammer. Put the screwdriver in the ignition and hammer it. Do so until it is possible to turn the screwdriver and the ignition or remove the ignition lock and then manipulate the ignition switch.

CHAPTER XVI:

DRONES

Note: Drones are very complex to handle so it is advised to have a specialized guerrilla crew for drone-work. These are the basics.

Drones are unmanned aircraft that can be remotely controlled and sometimes may be autonomous. Drones are widely available and legal. Drones and drone technology are a very complex field. The guerrilla which employs drones must know electronics, programming and aerodynamics. Drones can be used for multiple tasks in warfare or terrorism such as scouting, dropping bombs or manufacturing cheap missiles (so called loitering ammunition).

An example of scouting used by a modern terrorist was in the planning of the Christchurch mosque shootings. Brenton Tarrant had used a drone operated from a nearby park to investigate a mosque's grounds in January 8 2019.

Software

The software that comes with drones is not to be used by guerrillas. It prohibits the drone from flying over certain areas such as politically important buildings. There are multiple free and open-source alternatives to proprietary drone software. All that will have to be done is to flash them into the drone. First should be considered why the software should be selected. Is it for autonomous flight or getting the best possible control? Here are some examples and their specializations:

Paparazzi UAV: an open-source drone hardware and software project encompassing autopilot systems and ground station software for multicopters/multirotors, fixed-wing, helicopters and hybrid aircraft that was founded in 2003. Paparazzi UAV was designed with autonomous flight as the primary focus and manual flying as the secondary.

Get Paparazzi UAV: <https://github.com/paparazzi/paparazzi/releases>
Consult their wiki: https://wiki.paparazziuav.org/wiki/Main_Page

ArduPilot: Claims it's "the most advanced, full-featured, and reliable open source autopilot software available." That's probably not blowing smoke: it's installed in more than 1 million drones and other UAVs, including airplanes, helicopters, boats, and submarines, and it has a large number of contributors working on the project. Its features include advanced data-logging, analysis, and simulation tools, and it's supported by a broad ecosystem of third-party sensors, companion computers, and communication systems.

Get ArduPilot: <https://ardupilot.org/>

DroneCode:

The Dronecode project is a Linux Foundation-sponsored project working to build a common open source platform for UAV development. it serves as the governance structure for the components of the overall platform, where the project's actual

development occurs. Those components include the PX4 autopilot flight control system, the MAVLink robotics communication toolkit, and the QGroundControl user interface for flight control, mission planning, and configuration.

Get DroneCode: <https://www.dronecode.org/>

LibrePilot: The LibrePilot software suite is designed to control multi-copters and other radio-controlled drones. The project's roots lie in the Open Pilot UAV software project, and its goals are to support research and development of software and hardware for vehicle control and stabilization, unmanned autonomous vehicles, and robotics applications.

Get LibrePilot: <https://www.librepilot.org/site/index.html>

Loitering Munition

Autonomous drones have been used as the base of missiles. They should be programmed to crash into vehicles, bases and other important targets. By themselves this would not cause much damage but explosives could be placed on the drone. Drones are much smaller than missiles and fly at a lower altitude so they are much harder to detect. They will not be detected by conventional RADAR systems.

In January 2018, a swarm of drones attacked Russia's main airbase in Syria. The drones had fixed-wings made from ply wood. The drones came from approximately 50 km away. It is unknown who manufactured or sent the drones. No group claimed responsibility.



The type of drone employed against the Russian airbase.

In 2019, oil fields in Saudi Arabia were attacked by a swarm of 25 missile drones. The drones avoided detection by flying at low altitudes, evading the 120 degree vision of the air defense system. The oil fields were forced to shut down which halted 5% of the global oil supply. The likely perpetrator was Iran.

As can be seen, these attacks could be executed by nation-states and guerrilla organizations.

CHAPTER XVII: CLOSE-QUARTERS COMBAT

Knives

Note: This section was largely written by Don Pentecost.

Inside Folsom Prison, the maximum security penitentiary outside Sacramento, “fights” are resolved with deadly weapons, not fists. There are no exceptions. Because of this, knife fighting techniques are developed far beyond methods encountered on the street. This text will explain the difference between knife fighting fantasy and knife fighting reality. I have eliminated the ludicrous, ineffective techniques that will not work in the real world against a determined opponent.

Staying alive is the primary reason why you should never give your opponent a chance to defend himself. Be quick and brutal! When you use a knife, it is for one purpose only – to kill the enemy! Never give an opponent a chance to defend, think, or run. Once you have accomplished your final objective, leave the scene of the attack as soon as possible.

You must remember that technique is not the determining factor in a fight. Who applies the technique and who receives it are the primary determinants. Ruthless determination will overshadow technique or choice of knife every time. The will to win is more important than the skill to win. In a fight, mental attitude is crucial! Determination is the only thing that will get you off the ground after being stabbed.

No matter what techniques you end up using, the objective is to put the opponent physically down on the ground. Be certain he stays down. The time frame of a knife attack is usually very short – it is often over in a matter of seconds. Keep this in mind when developing offensive and defensive techniques and through all aspects of your training.

With all knife fighting grips, hold the knife as securely and tightly as possible to make sure it never leaves your hand during the attack. There are many ways to hold a knife, but the hit grip is the preferred grip for serious business. The hand is wrapped around the handle into a fist, with the blade extending from the top of your hand, between the thumb and the index finger. Your thumb is the key element for a secure grip.



Proper knife grip.

A proper knife fighting stance starts with a solid foundation. Your feet should be about shoulder width apart; keep your knees bent, and lean forward at the waist. Your lead hand is extended and open, ready to strike. Your knife hand is retracted and close to the body so your opponent cannot attempt to disarm you without bringing himself into your striking and stabbing range. Keep your eyes on the opponent at all times – as mentioned earlier, a

knife fight is often over in a matter of seconds. Remember this when assuming a stance, practicing footwork, etc.



A proper knife fighting stance.

A proper knife fighting stance starts with a solid foundation. Your feet should be about shoulder width apart; keep your knees bent, and lean forward at the waist. Your lead hand is extended and open, ready to strike. Your knife hand is retracted and close to the body so your opponent cannot attempt to disarm you without bringing himself into your striking and stabbing range. Keep your eyes on the opponent at all times – as mentioned earlier, a knife fight is often over in a matter of seconds. Remember this when assuming a stance, practicing footwork, etc.

There are two basic, effective frontal attacks. The first – the foundation of any frontal attack – is the one-two strike. Also known as a combination, one-two blows are individual techniques applied in a quick sequence. This is never a single blow – you must first lead with an empty-hand strike and then follow through with a knife thrust. Each technique must be effective and there should not be any hesitation between strikes. It is not difficult for a soccer goalie to block a single shot, but if a second and third ball were shot at the same time, at least one is likely to get through. The same is true in a knife fight.



The photographs show a one-two attack drill using a focus glove.

In a one-two attack, you first strike with your empty hand to create an opening. The eyes are the primary target. Actual eye contact is not as important as general vision interference. This will force your opponent to close his eyes, lose his balance, or cause him to overreact. One of these will be his natural reaction to your first offensive strike, and your opening will be created.

Empty-hand strikes should be quick and hard, and utilize the entire body, not just the arm. Fist or palm strikes can be very effective; however, a palm strike is usually best. You may also use a palm strike to grab for control. Following the empty-hand strike (or a convincing feint), the retracted knife hand thrusts immediately for the opening. Never allow your opponent time for a defense opportunity.

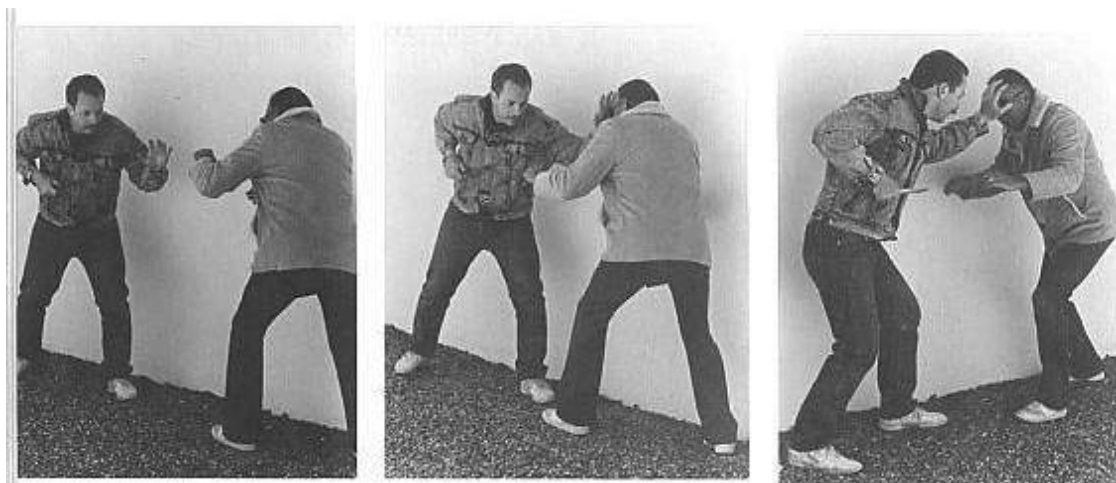

A lead hand strike to the eyes.

The second basic frontal attack is the three-step attack, also called a “deceptive lead.” Again, never lead with the weapon in the critical zone (the distance at which you can be hit by a particular individual). The safe distance is further than the opponent’s outstretched limbs. The only significant difference between the one-two attack and this method is that, in a three-step attack, you intentionally feint with the knife while out of range, luring your opponent into a premature strike. This will open his defense. Immediately enter the critical zone with the knife retracted and apply the basic one-two movement.

Stab the enemy until he is down, regardless of where you are punched, kicked, stabbed, elbowed, or whatever. Once your adversary is down, you must take him out. Make it absolutely certain that he will die.

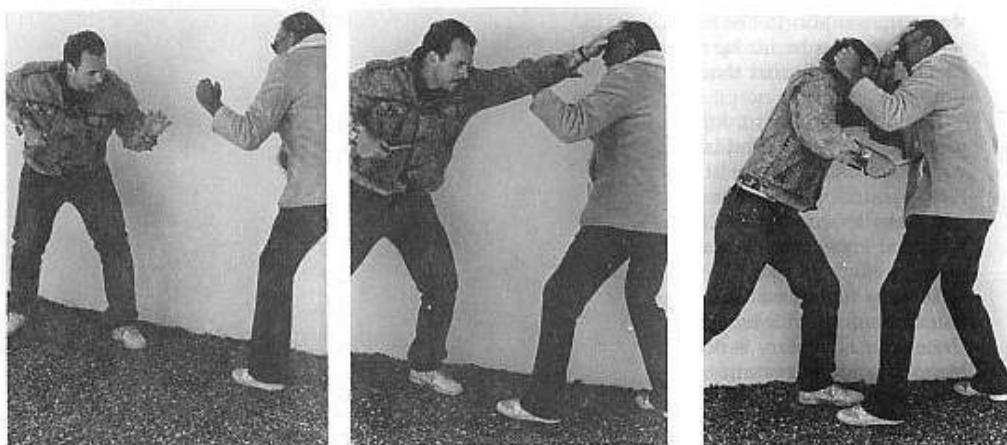

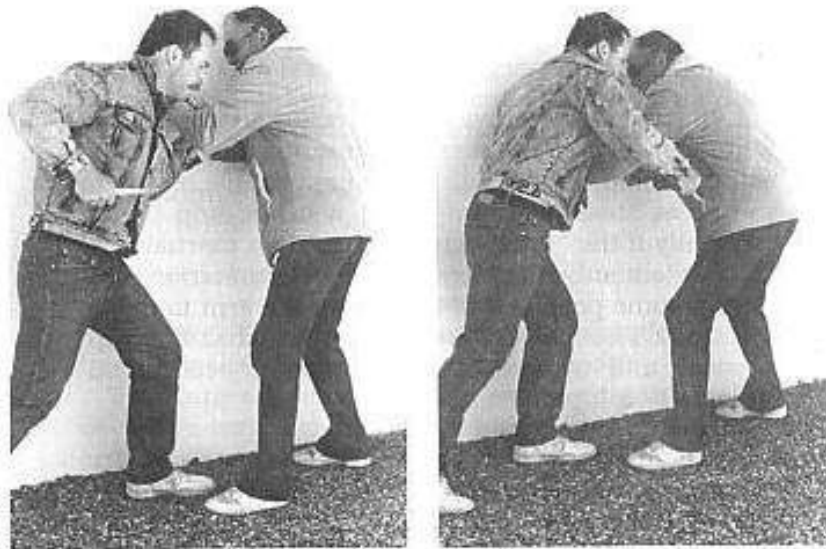

An effective attack combination. The attacker performs a one-two attack, then gains control of the defender's left side by grabbing his arm and then spinning him. The attacker stabs the exposed, unprotected area.

Your opponents left side is a primary knife target for several critical reasons. If you have control of your opponent's left side (or right side, if you are left-handed), it is difficult for him to protect that area which has become your most convenient target – his now exposed left kidney, lung, etc. It is even more effective if you can actually turn him to the side once you have control. After all, grappling does occur in knife attacks. Study the above photographs carefully.

An effective attack combination:

- 1) From an offensive knife stance, quickly step forward (lead foot first, rear foot following), closing the gap while simultaneously striking with the lead hand.
- 2) Immediately stab with the retracted knife hand.
- 3) Grab the left arm (or jacket sleeve, collar, back of neck, hair) and spin the opponent to your left, exposing his left side.
- 4) Continue stabbing the opponent in any exposed area, as many times as possible.

Do not aim for the heart. If you aim for the middle of the chest, your knife is apt to rebound off the sternum. If possible, stab the neck. This will cut the target's throat and guarantee their death.

The time between your empty-hand strike and the knife thrust should be as short as possible. Continue to pump the knife into the opponent until he is down and/or dead, depending on the situation. In a life-threatening situation, get whatever you can, when you can, as many times as you can!

On the next page are some photographs you can study:



One of the many examples of how someone can be stabbed during a grappling situation.



Another example of grappling and knives.

Now some illustrations of how to attack someone from behind.

Kidney Stab, Throat Cut: This technique relies on a stab to the kidney to induce immediate shock. The kidney is relatively accessible and by inducing shock with such a stab, the operative has the time to cut the target's throat. The operative completes his stalk and stabs the kidney by pulling the target's balance backward and downward and inserts the knife upward against his weight. The target will possibly gasp at this point, but shock immediately follows. By using the target's body weight that is falling downward and turning, the operative executes a cut across the front of the throat. This completely severs the trachea and carotid arteries.

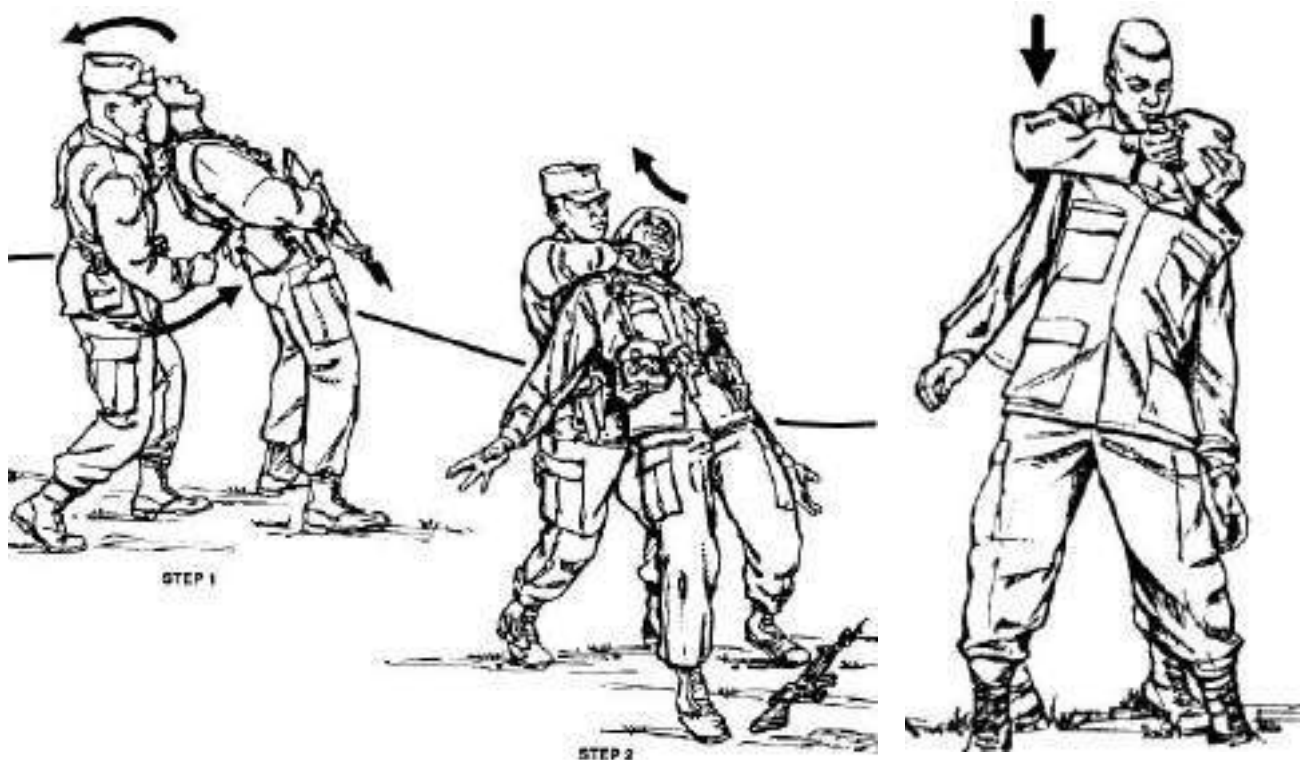

Nose Pinch, Mouth Grab, Throat Cut: In this technique, completely pinch off the target's mouth and nose to prevent any outcry. Then cut his throat or stab his subclavian artery. The danger with this technique is that the target can resist until he is killed, although he cannot make a sound.

If it is necessary to strike the target from the front or if you are in a self-defense situation, keep the knife out of view until you plunge it into the enemy. Use a backhand grip and hide the knife behind your wrist. At the last instant flip it to a front grip and thrust it upwards dead-center into the solar plexus. Pull it down and turn it as you rip it out. The target's guts will spill out along with copious amounts of blood. He will make very little sound if any but you will be soaked with blood.

Other Melee Weapons

A machete is a very good weapon for killing. It is commonly used as a tool for cooking, butchering or removing foliage in jungle regions. Rush your opponent similarly with the

knife. The better thing about the machete is that it is almost impossible to block because it is way sharper and longer.

An icepick or a similar thrust-only type weapon can be used to produce wounds which will bleed much less than those inflicted by a knife. This is a definite advantage for selective assassination where the operative must make a getaway without being spotted with bloodsoaked clothes. The wounds are, however, not nearly as lethal as those produced by a knife. The kidney attack can be made with an icepick but a direct thrust into the heart or brain will be more likely to produce a fatal wound.

A hammer can be used to produce lethal injuries silently and almost completely bloodlessly. A very hard blow to the head with a standard claw-hammer is almost certain to kill, a follow up blow or two will certainly do the trick. Again an attack from behind will be most effective, strike as hard as you can.

A thin length of strong rope, cord, or even a belt can be used to make a garrote which can be used from behind for silent and bloodless killing. Loops or handles are often added to the garrote in order to increase the effectiveness of the attack. Surprise is absolutely imperative when using one of these weapons.

Unarmed Combat

“Everyone has a plan until they get punched in the mouth.” - Mike Tyson.

This introduction will explain the basics of hand-to-hand combat, and will tell of the best places to strike and cause severe injury an enemy. When engaged in hand-to-hand combat, your life is always at stake. There is only one purpose in combat, and that is to neutralize your enemy. It's the law of the jungle, there is no respect in a real fight. Never face an enemy with the idea of defending yourself. The chances are extremely good that he will severely injure or kill you instead. You will have to be on constant attack. No one has ever won by defense in a fist fight. When a weapon is not available or has been knocked out of your hands, one must resort to the full use of his natural weapons: that of your anatomy. The natural weapons are:

- The protruding knuckle.
- Elbows.
- Knees.
- Feet.
- Head.
- Teeth.

Attacking is a primary factor. A fight was never won by defensive action. Attack with all of your strength. At any point or any situation, some vulnerable point on your enemies body will be open for attack. Remember that there is no respect in this fight. You can bite your opponent, gouge out his eyes, choke him, headbutt him, and punch him in the groin if the possibility arises. The main point of this is so you can retrieve your proper weaponry as quickly as possible.

Your balance and balance of your enemy are two important factors; since, if you succeed in making your enemy lose his balance, the chances are nine to one that you can beat him in your next move. Always try to throw your enemy off balance. The best over-all stance is

where your feet are spread about shoulders width apart, with your right foot about a foot ahead of the left. Both arms should be bent at the elbows parallel to each other. Stand on the balls of your feet and bend your waist slightly. Kinda of like a boxer's crouch. Employing a sudden movement can throw your enemy off-balance.

Use any available object that you can. By this I mean throw sand in his eyes, block his strikes by hitting him with a large branch, or any other kind of available material that can be used as a weapon against him.

Always look for a weak spot and attack it. Whenever he leaves a vulnerable part of his body unprotected attack it with all your strength. By doing this, he will then try to protect the part of his body that you just struck thus leaving even more unprotected parts open. Here are some vulnerable points:

- Eyes: easily gouged with your fingers in a V-shape.
- Nose: Aim for the bridge. Breaking someone's nose will cause tremendous pain.
- Upper lip: A large network of nerves are located. These nerves are extremely close to the skin. A sharp upward blow will cause extreme pain.
- Throat: This spot is usually pretty well protected, but if you get the chance, strike hard. Your opponent will lose breath and begin to choke.
- Temple: There is a large artery up here, and if you hit it hard enough, it will cause death. If you manage to knock your enemy down, kick him in the temple, and he'll never get up again.
- Back of the head: Very vulnerable spot. There is a reason it's forbidden to hit someone there in boxing.
- Groin: A very vulnerable spot. If left open, get it with knee hard, and he'll buckle over very fast.
- Kidneys: Very vulnerable spots. A kick to the kidneys will likely cause the opponent to fall over.
- Liver: Will lay just over one of the kidneys, slightly sticking out under the rib-cage. If hit, your opponent will fall to the ground in pain. This will give ample time to retrieve your proper armory.

To produce a correct punch, the punch should be landed on the protruding knuckle. If the punch lands on the ring finger's or little finger's knuckle, your hand may very well break. Keep the thumb out of the fist, wrapping over the fingers. If the thumb is tucked in, it could break when punching someone. Weight should be put into the punch. You could bend your bust and or bend the thigh on the punching arm's side towards the target to add on their weight to the jab-type punch. Going upwards would add weight to an uppercut-type punch. Do not put all your weight in the punch, as that will cause you to lose balance.

There are multiple martial arts which the guerrilla could learn to further aid his capabilities in unarmed combat. The best choice is MMA, as it is a mixture of the best techniques used in Boxing, Brazilian Jiu-Jitsu, Wrestling, Karate, Muay Thai, and numerous other disciplines. All of the bad techniques will have been weeded out in MMA. Note down banned techniques in MMA. These techniques are banned because they are extremely dangerous. Eye gouging, kicking the groin and punching the back of the head are some banned techniques.

CHAPTER XVIII: SABOTAGE

Vandalism

The psychological and economic impact of vandalism should not be underestimated. Trash the place: shatter windows, destroy payphones, throw furniture around, slash tires, ignite fire-crackers, commit arson and graffiti anti-status quo slogans and symbols. Ensure that your likeness is not captured by surveillance cameras or if in a riot people recording with their smartphones.

Pellet guns, BB guns and slingshot are all useful for certain acts of vandalism and sabotage. These types of weapons are widely available and are unlikely to be banned by even the most repressive governments. Weapons of this type can be used to break windows and damage property at a distance with little noise. Another method to do so would be to pick up rocks and throw them against cars or windows. Wear gloves when doing so in case vandalizing an important location.

Bombings as vandalism

Bombings against important structures that result in no injuries are an effective terrorist method. There are two types of targets: civilian and enemy. Civilian targets are to cause unease in the population. Select religious buildings or theaters. The bomb should be placed somewhere that will maximize propaganda potential, not structural damage. The image of a building's trashed insides is much less terrifying than people flocking to see the destroyed entrance. Enemy targets should be bombed to cause as much economic damage as possible although propaganda may sometimes intersect.

Roadblocks

Note: This section is largely from the Werwolf combat manual translated by Lt. Michael C. Fagnon.

Roadblocks are an important means of guerrilla warfare. They are employed together with ambushes to hinder pursuit by motorized troops and to harass enemy traffic. The effectiveness of obstacles can be multiplied through the use of hidden explosive charges. The guerrilla group must always be able to set up simple roadblocks with the means available. Training must enable the guerrillas to choose and build an obstacle best suited for the number of men and means available. When ambushing on heavily frequented roads, obstacles in the form of mines must be employed. Mines must always be carefully camouflaged. Destruction of bridges made of iron, masonry, or wood by demolition, requires considerable amounts of explosives and a thorough instruction in handling of explosives and fuses and in calculating the charges. This is a subject of special instructions and regulations. Even without explosives and mines, guerrilla groups can set up obstacles that will efficiently hinder the enemy.

Single trees can be chopped down so that a stump of about 1 to 1.5 meter's height is left standing. The treetop must fall in the direction of the road, and the whole width of the street must be obscured (figure 1).

The direction in which the tree should fall in is determined by a notch (1/5 to 1/3 of the diameter). Saw cuts should end in this notch. Jamming the saw is avoided by using a wedge. The growth of the tree and branches of other trees may influence the direction in which the tree falls. In this case, push the sticks or pull with ropes in the direction necessary (figure 2).

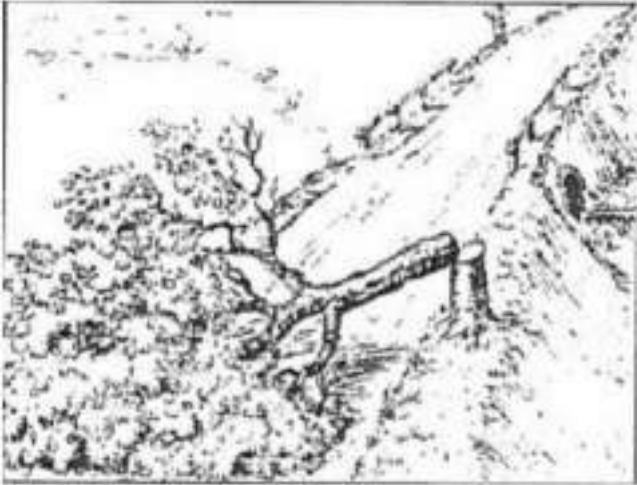

Figure 1. Single tree blockade.



Figure 2: Notches for the direction of fall.

Tree blockades are made by cutting down trees over a distance of 20 to 30 meters. The trees should fall crosswise over each other, with the treetops towards the enemy and outwards so that visibility into the obstacle is obstructed. Only trees in favorable positions are cut (figure 3).



Destroying a road: The road is dug out over its complete width, 2 to 3 meters wide and 1 meter deep. The earth is thrown down the embankment (figure 4). This obstacle is very

effective in mountains on roads that run along slopes. Repair of the street is complicated if the bottom of the ditch is angled downhill (figure 5).

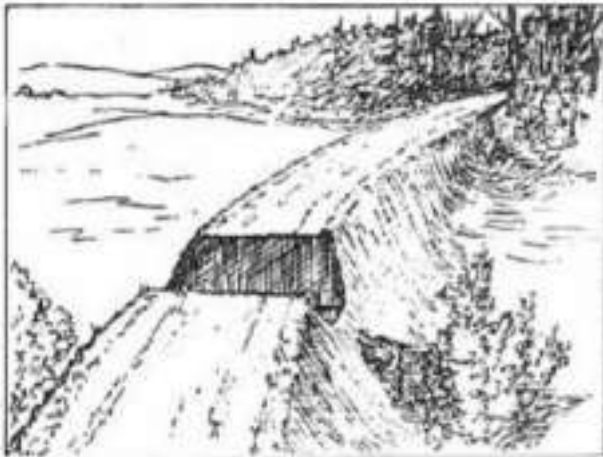

Figure 3. Destroying a road.

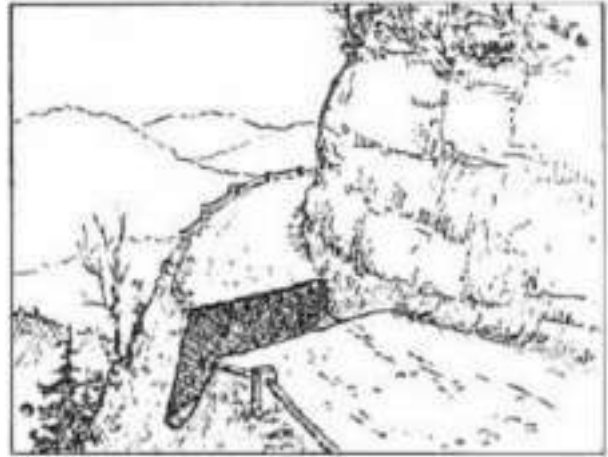

Figure 4. Destroying a road.

Wrecking wooden bridges is sufficiently effective if the planks and support beams of some parts of the whole bridge are removed. Destruction is completed by sawing through or removing the supports. The wood must be removed or rendered useless by chopping or cutting it. Against armored vehicles and light reconnaissance plants, the wrecking can be camouflaged by sawing the beams only halfway through. The bridge will collapse after a vehicle has driven on it.

It requires a long time to prepare the incendiary destruction of wooden bridges. The fire must be nourished from below. Therefore, a large quantity of flammable material like tar, pitch, oil, gasoline, petroleum, straw, etc. is necessary and must be fastened under every beam and all supports. Hanging or setting up containers (barrels, Jerry cans) filled with flammable liquids directly under the planks, pouring engine oil over the bridge before igniting it and so forth, will accelerate the destruction. Sufficient draft is created by removing some planks. Destruction of a large bridge by burning it down requires 5 to 10 hours.

Phony barriers: Long lasting obstruction of a road is achieved by erecting several echelons of barriers in depth. The effect of barriers is multiplied by phony obstacles. They must be identical to real barriers. Phony barriers should be erected in connection with the real ones or in alternation with real ones. A phony barrier will only be effective if the enemy notices it and if he has encountered a similar real obstacle before. If mines have already exploded in the direction of the enemy, motor vehicles will be easily stopped by a simple wire or wire rope, a conspicuous sign on the road, fresh tar spots on the asphalt of the road, brushed spots on cobblestones, freshly repositioned cobblestones, dug up and refilled holes, iron pieces or pieces of wooden planks placed on earth, and wires leading into the earth near chopped down trees.

When setting up phony barriers, a great variety should be tried. In general, the following fundamentals must be observed when setting up barriers:

- It should not be possible to bypass the barrier.
- The enemy should come upon the barrier unexpectedly (behind curves, bushes, etc).

- The barrier should be watched and be under control by one's own fireteam or reinforced through hidden charges.

Large barriers (tree blockades, destruction of roads, wrecking of bridges) which require more men and longer time can only be accomplished under favorable circumstances. Help of the population is mostly necessary. When laying mine barriers, care must be taken that other persons do not observe the work.

Denial

Denying areas of basic necessities is another method of sabotage. A significant amount of damage can be inflicted against government and corporate interests with the use of sabotage. Denial of services such as electrical power, fuel supplies, water, food supplies, communications or transportation will encourage the kind of civil unrest and panic we require in order to carry out more of our program.

The electrical power supply is absolutely essential to the life of any metropolitan area. Heating and air-conditioning, food distribution, transportation, hospitals and most businesses require electrical power in order to function. Loss of these services for any extended period of time will cause very serious civil unrest. The power generation and distribution systems of most major Western cities are surprisingly vulnerable to attack. With the exception of nuclear power plants, most power systems are unguarded and can be taken down with explosives, arson or by damaging essential parts with long-range rifle fire.

Most of the world's electrical power is generated at coal powered generating plants, hydro-electric dams and nuclear power plants. Some power is generated from solar panels, windmills, geo-thermal generators and other clean technologies but Capitalists and Communists alike care little for the environment and therefore these technologies make up only a tiny percentage of the total power output.

Attacking the power supply at the source has the advantage of creating a total blackout of the supplied area with just one attack. The heart of the generating system must be destroyed. Hydro turbines, coal-powered boilers and nuclear reactors are very expensive and complex systems which cannot be quickly repaired or replaced. Destruction of these systems will force authorities to divert power from other plants in order to prevent disaster. Attacking during peak consumption times (Winter in cold climates and Summer in hot climates) will make power diversion impossible. It is unlikely that the guerrilla will be able to sabotage nuclear reactors because of the strength of concrete used.

Power distribution systems are also very vulnerable and nearly impossible to defend against attack. Again arson, explosives or long-range rifle fire can be used to disable substations, transformers and suspension pylons. A simultaneous attack against a number of these targets can shut down power for nearly as long as an attack upon the generation source with the advantage that service cannot be quickly restored by diverting power from another source. Each broken link in the power grid must be repaired in order to fully restore service.



Pole transformer.

Explosives, incendiaries or long-range rifle fire can be used to disable substations. An individual, equipped with a silenced rifle or pistol, could easily destroy dozens of power transformers in a very short period of time. Suspension pylons can be destroyed with explosives or by whatever mechanical means are required to knock them down or short them out. A length of steel cable or chain with a weighted end can be simply thrown over the wires allowing power to arc from one wire to another and shorting out the system.

The economies of most Western nations are dependent upon the movement of workers and products. Attacking **fuel supply and distribution** can drive fuel prices skyward or even result in rationing of fuel. Without a steady supply of affordable fuel, vehicular travel will dwindle, resulting in very serious economic problems for governments and corporate interests. Gasoline, diesel, heating oil and natural gas systems are very vulnerable to arson attacks and explosives.

Oil refineries are massive operations and will require a carefully planned attack in order to put them offline. Stopping the supply of raw crude oil to a refinery would be a much simpler task.

Fuel storage tanks are constructed to withstand a certain amount of punishment, such as being run into by a truck, but can easily be ruptured with a powerful charge of high explosives. These facilities are often unguarded and make for very tempting, high-value targets.

Pipelines are even more vulnerable to attack than storage tanks. Pipelines can be more readily destroyed with explosives or pipe sections can be unbolted, separated and the fuel ignited.

Drinking water is absolutely essential to the stability of any urban area. Denial of **water supplies** service will cause panic within hours. Water purification plants are surprisingly unguarded and vulnerable to attack. Massive holding tanks, pumps and filtering equipment can be destroyed with explosives.

ARSON

Arson is executed by setting property or wilderness aflame. Arson is one of the easiest crimes to commit and one of the most difficult for law enforcement to investigate. There are many targets to execute the arson mission on and two of these targets will be written about in this section of this document. Those two are buildings and the wilderness. Arson is optimal during dry and windy weather. Fire needs oxygen, fuel and the ignition to be. Oxygen is found in air and wind. Fuel will be any very flammable substance and then the building or nature itself. Gasoline, kerosene, diesel, any lighter fluid and especially napalm will work as great fuels. If the fuel is to produce smoke mix 1/2 engine oil with 1/2 gasoline.

Buildings

Any type of infrastructure which can be destroyed or disabled by fire may be attacked with incendiary devices. Electrical power generation and delivery, food supplies, fuel supplies and various government and corporate capital make excellent targets for arson attacks.

Arson investigations deal primarily with the question of whether or not a certain fire was an arson. Arson investigators are able to tell where a given fire originated, what type of incendiary device or chemical accelerant was used and if more than one fire was set. The operative will, for propaganda reasons, want any arson attacks conducted to be recognized as such by the "authorities". The operative must be aware that vapors from accelerants used often remain after a fire has been extinguished and can be analyzed by investigators. These tests can provide investigators with evidence if accelerants discovered in the operative's possession can be matched to evidence at the crime scene.

The lethality of the arson attack can be increased by ensuring that any possible escape routes are denied and that emergency services are occupied elsewhere. This can be executed by setting fires in hallways preferably in a building without emergency exits and occupied by loud noise.

In a high-rise apartment building, the elevators must be disabled before the attack. This is best accomplished by setting their interiors ablaze with flammable liquids. Next the main fires must be set in the hallways of the first few floors. Start the fires at the ends of the hallways near the stairwell doors in order to drive escapees away from the stairwells and toward the (inoperative) elevators which are usually located in the middle of the hallway. Once this is accomplished the stairwells must next be filled with flame and smoke.

The operative must conduct surveillance to determine where the exits are, if they are kept locked (as they often are in these places to keep people from sneaking in without paying), how many security personnel are usually on duty and how alert and effective they are. Again all possible exits must be denied. Firebombs thrown or placed at the exits will cause enough panic to result in injuries and fatalities as patrons trample each other to find a way to escape. Most casualties in fires of this type are from smoke inhalation or crush injuries caused by fleeing crowds. Choose a time for the attack when the greatest concentration of enemies will be present.

An arson fire will burn more quickly and thoroughly if fires are set in multiple locations around and within the target. Set fires where there is sufficient flammable material to allow flames to spread quickly. Fires burn upwards, of course, therefore fires should be set at the lower levels of a building or structure. Fuel containers, wooden furniture and building materials, plastics, carpets and curtains all make good fuel sources for arson fires. Simultaneous arson attacks at several locations will force emergency services to either "prioritize" one or two targets and let the rest burn or to spread themselves thin and try to deal with all of the targets. Either way the attacks will be much more effective than if they were conducted separately.

Another method that could kill a lot of people would be to splash fuel on the targets and then set them on fire. Gasoline will be best for this, and multiple liters of it. Enter the target location. The location is to be crowded, cramped and with little exits for optimal results. Take out the can filled with fuel. Splash the crowds of people with the fuel. The splashing should

only take seconds. Throw the can when the can has been emptied of fuel or when the crowd is beginning to realize they are being covered in fuel. Ignite the fuel before a person in the crowd attempts to tackle you. If you are planning to set yourself on fire too, carry flammable explosives around your chest. Preferably stand near an exit, as people will attempt to run away from the explosion.



With 40 liters of gasoline, this is what Shinji Aoba managed to do to the Kyoto Animation Studio 1 building. 36 people were killed. He employed the splashing technique.

Wilderness

Nature can be the target of arson for causing economic damage. Nature itself has caused massive fires which are considered natural disasters. For example the California fire of 2009 caused more than 2 billion dollars in damages. The location selected is to be placed on the opposite direction of the wind. It is optimal to set aflame the tree crowns in forests where the branches between the trees are concentrated. It is advised to select multiple locations to execute arson on. Doing so will strain the firefighters which will be sent to the locations when they are alerted of the forest fires. You could set up time firebombs. Executing arson in nature is unlikely to cause any deaths of person but will cause massive economic loss.

Optimal weather: Very dry, very windy, very hot.

Note: Beware that during some wildfire outbreaks the police may place hidden surveillance cameras in the wilderness. A man in Italy who set wildfires was caught this way.

“Pillows”

This a method used by John Leonard Orr (nicknamed the “Pillow Pyro”) to cause several hundred arson attacks. He was a firefighter and was only identified due to him being connected to the places that were attacked.

The device is made with a cigarette with matches wrapped in ruled writing paper and secured by a rubber band. The cigarette is lit and after a set amount of time, the fire will set the matches and paper on fire. This will cause the fire. Orr was called the "Pillow Pyro" as he hid these devices in very flammable cotton pillows. So all he had to do was light the contraption, put it in a pillow, and then hide the pillow at the target location. Ensure that the cigarette will be able to reach the match-heads. Do not put the cigarette in your mouth before usage. The DNA from your spit may remain after the fire.



CHAPTER XIX: HARASSMENT

The purpose of threats and intimidation is to force the target to alter his/her behavior, go out of business, move away, or increase spending for security, or to somehow retaliate. Only a sustained campaign of harassment can accomplish this. It should be possible for a resistance cell or a lone-wolf to conduct several campaigns of this nature simultaneously.

Different people take harassment in different ways. Mentally strong individuals will often tolerate harassment rather well. Members of minority groups will be easier to intimidate because of their lack of population and or history of oppression. Famous and influential people are much harder to intimidate even if they are members of small minority groups. The easiest people to intimidate are probably autistics, transsexuals and other mentally unstable people. For political reasons, the best to intimidate would be journalists, activists and local enemy politicians.

Death threats are most effective when directed at an individual. Use surveillance to discover some facts about the target and use these to increase the intimidation effect. A photo of the target, taken during surveillance and delivered along with the death threat, will convince the target that the threat should be taken seriously.

Methods of intimidation include vandalism, death threats, spreading of rumors, smear campaigns, swatting (calling law enforcement on an individual over false pretenses) and insulting. The insults must be ones of no respect. Another method of harassment common today is doxxing.

Doxing

Doxing (also spelled doxxing) is the act of publicly revealing previously private personal information about an individual or organization, usually through the Internet. It is a very effective method of intimidation especially if paired with the possibility of ruining the target's personal life. This could be done by reporting the illegal internet activity of the target to police if the target used child porn, bragged about acts of violence and vandalism, or was planning an operation. This may also be used as blackmail. Most of the time an incomplete dox will be enough for intimidation.

A dox posted about a person could include this information:

- Pictures of them.
- Name.
- Age.
- Residence.
- Place of employment.
- Family members.
- Social media links.
- Telephone number.
- Credit card information.

Note: Beware that doxing is illegal in some regions. Use the appropriate software when posting doxes.

There are multiple methods to dox someone. A combination of all these methods is to be employed for better doxing. Here are some of the methods:

Username: Individuals may use the same username for different accounts. One of these accounts might have personal information attached. Search for the individual's username on hacked databases of website leaks. Here are two resources:

- <https://pipl.com/>
- <https://www.whitepages.com/>

Email: An email can be searched up on Facebook to see if anyone has registered an account with that email.

Associates: Note down information about associates of the individual, especially if they are the individual's partner, sibling, cousin or real-life friend. They might reveal more information about their general region.

IP addresses: IP addresses can be used to track down the general location of a target and to ddos them. The target entering a server you own without proxy or tor or clicking on an IP grabber link you operate are ways to get an IP address. Here are two resources for extracting information from IP addresses:

- <https://www.iplocation.net/>
- <https://www.whois.net>

Time of activity: When is the target available? When are they offline? When do they comment on the weather and what is the weather then? Note these things down. Eventually the information will accumulate and fit for 1 or 2 timezones and a specific region.

Interests: What are their interests, beliefs and opinions? Note them down. This information may be used to confirm beyond reasonable doubt that a personal social media is owned by the target.

Recording calls: Secretly recording voice calls will save the sound of the target's voice, save whatever they say for later and save any accidental personal information the individual says or their family, friends or partner tell them while in the call.

Reverse image search: Images posted by the individual could be put into reverse image search websites to see if they have been posted by the individual on other unknown accounts. Here are some tools:

- <https://images.google.com/>
- <https://tineye.com/>
- <https://yandex.com/images/>

Metadata: Images and other files posted by the individual could contain metadata for doxing. This is especially the case for photographs. Image metadata can be viewed in the properties of an image. Metadata could reveal the location of the photograph and the software and hardware used for taking it. Some services such as Discord wipe metadata upon upload.

Pinging: This is a more novel method for doxing. Get the target to play an online video game with you. Note down their ping on each server that is played on and note down the server location (retrieve the IP). Also note down if the server is healthy and well otherwise. Do not rush this process. This process may take multiple days.

The lower the ping, the closer the target is to the server. Make a map of all the servers and note down their health and what ping the target had when playing on them. The lower ping servers should cluster near the target's location. Repeat the process but this time on other servers in the general region where the ping was low. The possible location of the target will grow smaller and smaller.

It may be possible to execute this method with Discord. Get in a voice chat channel with another user and note down their ping. Then note what region the server is set to. This is less precise than the online video game method.

It may also be possible to triangulate the target's position with the ping but the unreliability of server health might interrupt the procedure. Lines could be drawn out of the server points on the map in the direction of what the cluster points to is the target's location.

Doxing parties

A very effective method against large communities of civilian enemies on services such as Discord is to have organized online groups use most of the methods discussed without involving themselves in the server too much. Appear to be a simple reader. The account should be a throwaway used for nothing else. Save all the information to a large document. When the group has decided it is enough, leak the document. The community will be terrified and have no idea who was behind the doxing. The doxing may not be perfect but will instill fear in the targeted community and cause members to leave or become silent.

CHAPTER XX: MASS-SHOOTING OPERATIONS

Mass-shooting operations require little technical knowledge to execute and will result in many fatalities. They are most often planned and executed by a lone-wolf but may be executed by multiple guerrillas. There are two separate goals a mass-shooting operation attempts to reach which are to either cause as many enemy fatalities as possible or kill and injure multiple specific and defended targets.

Consider the attack on Utøya (69 killed, 66 injured) and the 2016 shooting of Dallas police officers (5(+1) killed, 11 injured). While the Utøya massacre killed many more it killed people of little power but still of political worth (supporters of the status quo). The attack on the Dallas police killed police officers which are much more important to the system. The killing of 2 police officers is as important as the killing of about 20 civilians.

An attack on unarmed civilians should kill at least 15. An attack on politically important buildings should kill at least 5 intended targets. An attack on armed personnel should kill at least 2 intended targets.

Target

The method the terrorist uses in the mass-shooting will vary depending on the target. In close-quarters areas such as buildings the terrorist must fire quickly and be extremely aggressive. In open areas the terrorist should take good positions and open fire on crowds. Study the target before executing the mission. Preferably visit the target.

Common buildings such as offices, schools and religious buildings are likely to cause the most fatalities. Large crowds of unarmed civilians collect in these buildings. Beware that some doors may be locked by people fleeing. Common buildings also often have large windows into rooms or glass doors which could be shattered into. Glass doors and room windows are very important considerations. The terrorist could begin the operation in the hallway by smuggling and equipping the armory in the bathroom. Then after 10 or 20 seconds of firing he would open fire through the door to break it and then shoot the crowd in the room with nowhere to flee. This is so if the room has no emergency exit.

The targets will attempt to defend themselves. Beware of people hiding behind corners ready to attack, people jumping out of crowds during reload and people throwing furniture. The most dangerous are people who use the fire extinguisher. The foam could throw the terrorist to the ground and freeze them and the fire extinguisher itself is a very heavy blunt weapon that could break bones. Some people will go further. Abdul Aziz for example equipped an empty firearm dropped by Brenton Tarrant during the Christchurch mosque shootings. Aziz chased Tarrant with the gun and threw it against Tarrant's car windows. He survived the shooting unharmed.

Some locations will have more police employed such as shopping malls and religious buildings that are commonly vandalized. Common law enforcement is equipped with hollow point bullets so ballistic armor will be very important. These bullets shatter when

impacting ballistic armor. Some targets will have specialized law enforcement and military employed such as in cities like Jerusalem. These attacks are unlikely to cause many fatalities and very likely to make the terrorist's life contribute to the final death count.

Large open areas are very effective if there is lots of time and people. Islands are perfect for this reason. It is difficult for people to flee and people fleeing by swimming could be shot at. People are also unlikely to hide at one location during the whole mission and may change positions to be saved by incoming boats. Open fire on any close by boats and spy on where incoming boats are attempting to arrive. There may be a crowd there. The terrorist must aim well in large open areas.

A method in large and very crowded areas would be the strategy executed in Las Vegas in 2017 (60(+1) killed, 867 injured). This would involve taking a position some over the crowd and firing downwards. The position will remain more hidden if taken a distance from the target and in an area with many tall buildings that will cause the gunshots to echo. This operation could employ multiple firearms and especially automatic rifles or rifles with a bump stock as the likelihood that a firearm will overheat or fatally jam is high.

Politically, good targets would be:

1. Enemy institutions close to the government such as lobbying groups, businesses and powerful foreign colonizers.
2. Government offices of less powerful governments.
3. Government offices in quick ambush operations.
4. Areas with unarmed status-quo personnel when attacked from within.
5. Parades or demonstrations organized by enemy groups.
6. Police positions in demonstrations fitting for ambush.

Examples of all four:

1. 2021 Dar es Salaam shooting (4(+1) killed, 9 injured).
2. Zug massacre (14(+1) killed, 18 injured).
3. CIA headquarters shooting (2 killed, 3 injured).
4. 2009 Fort Hood shooting (14 killed, 32(+1) injured).
5. 2021 Beirut protest shooting (6 killed, 30 injured).*
6. 2016 shooting of Dallas police officers (5(+1) killed, 11 injured).

*Multiple shooters.

Some targets are impossible to attack. Some targets will cause little deaths but massive damage to the status quo. These attacks must be executed with surprise and ambush. Without surprise expect the shooting to end like the 2019 Dallas courthouse shooting (1 injured and 1 dead perpetrator).

Armory

What type of armory is used will be very important. For close-quarters ambush attacks a semi-automatic rifle or handgun will be used. Two handguns could be carried or a rifle with a handgun sidearm in case of the main weapon jamming or someone attempting to attack you during reload. Shotguns may be used in slightly more open buildings with less crowds to allow for easier reload. These shootings will cause less fatalities. Las Vegas-style attacks could be executed with semi-automatic rifles, automatic rifles and sniper rifles.

Ballistic armor may be worn in case of police presence. A knife could also be carried in case the side arm fails. A hypothetical method that may work is to attach razor blades pointing outwards on the clothing worn by the terrorist. The terrorist may carry a suicide vest but not if there is risk of being shot. The suicide vest may detonate early.

Note: If using 30-round magazines, put in 28 rounds. This will decrease the risk of a jam after firing many shots. Do the same with other magazines. Do not fill them to the brim.

Maximizing Fatalities

An important factor the terrorist must take into account is that the amount of fatalities that can be executed in a location will increase logarithmically. This is because of the element of surprise. People will flee, hide or play dead after the first attack and crowds disperse. The deadliest section of a mass-shooting is often the first minute. The terrorist could maximize fatalities by switching locations after this procedure:

1. Ambush a large crowd in a building (20 seconds).
2. Shoot at nearby fleeing people (40 seconds).
3. Put execution shots into the ambushed crowd's bodies (60 seconds).
4. Continue to next location and repeat.

2 minutes will have been spent on the location. A wristwatch would be handy.

Execution shots can be administered with a quick shot to the head. To make death certain then aim for the temple or the place where the brows and nose meet.

Outside or inside?

Starting the mission outside the building is to be avoided. It must however be done if carrying much gear. Most shootings do not fail such as with the Columbine high school massacre (13(+2) killed, 24 injured) and the Perm state university shooting (6 killed, 47(+1) injured). Some succeed such as the Christchurch mosque shootings (51 killed, 40 injured). Most successful shootings begin inside as with the Virginia Tech shooting (32(+1) killed, 23 injured) and the Port Arthur massacre (35 killed, 23(+1) injured).

In slightly more than a minute, Martin Bryant killed 20 people and injured 12 with 29 shots in the crowded café and giftshop he targeted in Port Arthur. He had equipped the firearm out of a sporting bag in the middle of the café and opened fire. The rest of the shooting was spent on chasing people in the parking lot, stopping cars and shooting the passengers and holding a hostage. The attack lasted for multiple hours but Bryant only killed 15 more people with all that time instead of targeting another crowded building.

CHAPTER XXI: GUERRILLA ORGANIZATION

Note: This chapter was largely written by Cpl. Vernon Itas.

Clandestine Cell System

A clandestine cell structure is a method for organizing a group in such a way that it becomes virtually immune to detection, penetration and decapitation. As such, it is a critical strategic element of our operations. It is not in any way lead under a fixed, fragile hierarchy but works as an extremely distributed movement, a resilient network made up of small, autonomous groups or cells. Each group is lead by a cell commander, often working solo, who makes all the decisions based on fixed fundamental principles.

Solo Martyr Cells are completely unknown to our enemies and has a minimal chance of being exposed. The relatively indestructible and impenetrable nature of the Cell System allows the individual to stay hidden until he is ready to "activate" himself. Optimally he should not have any affiliations to "extremist networks" or to any extreme movements for obvious reasons. Our evolving approach to conducting warfare makes it extremely quick to innovate and share tactics rapidly from cell to cell without the direction of a vulnerable leadership hierarchy.

As a general rule. You will increase your chance of being apprehended by 100% for every person you involve in the West. Don't trust anyone unless you absolutely need to. Do absolutely everything yourself if there is not a powerful organization.

Internal cadres of our movement should be organized into cells of three persons, with only one of them having contact outside of the cell. The three-man cell is the basic element of the movement; it has frequent meetings in order to receive orders and pass on information to the cell leader. These meetings are also very important for the cell members' encouragement of each other as well as for their morale. They should carry out self-criticism on the successes and failures in completing individual missions of subjective control. Coordination of the three-member cell provides a secure network for two-way communication, each member having contact with only one operational cell. Members shall not reveal in cell coordination meetings the identity of their contact in an Operational cell; they shall divulge only the nature of the activity in which the cell is involved, e.g., political party work, medical association work. There is no hierarchy of cells beyond an element of coordination with the Zone Commanders through whom direct, but secret, contact will be maintained with the commander of our guerrilla group in the operational area or zone. For every three Operational cells we need a coordination cell.

The underground is primarily organized into cells (fig. 48). The reason for this organization is security. The individual agent does not know the other agents; he has operational contact with the cell handler only. The cell handler manages the cell. At most, only four people can be compromised. The cell handler reports to a network manager through a "cutout" (fig. 49). Net managers get their orders and direction from the area underground director. The director reports to the area commander.

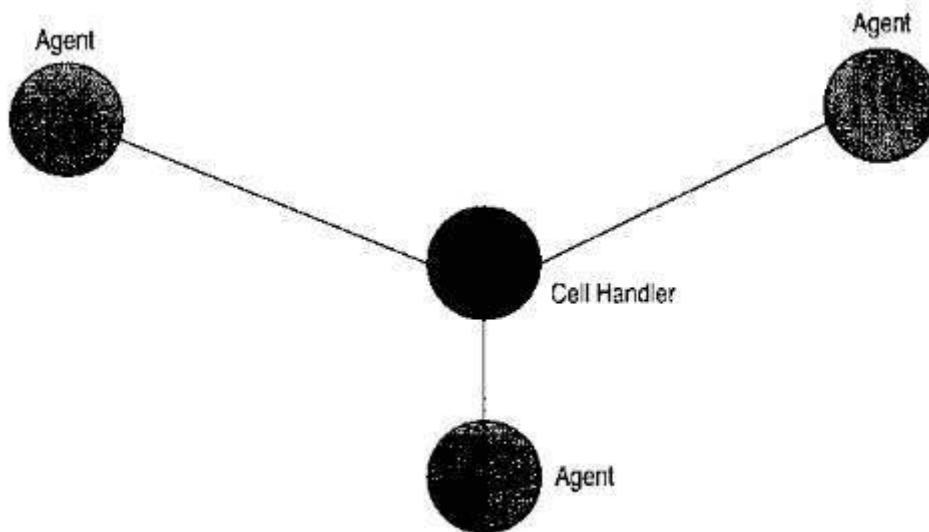

Figure 48.

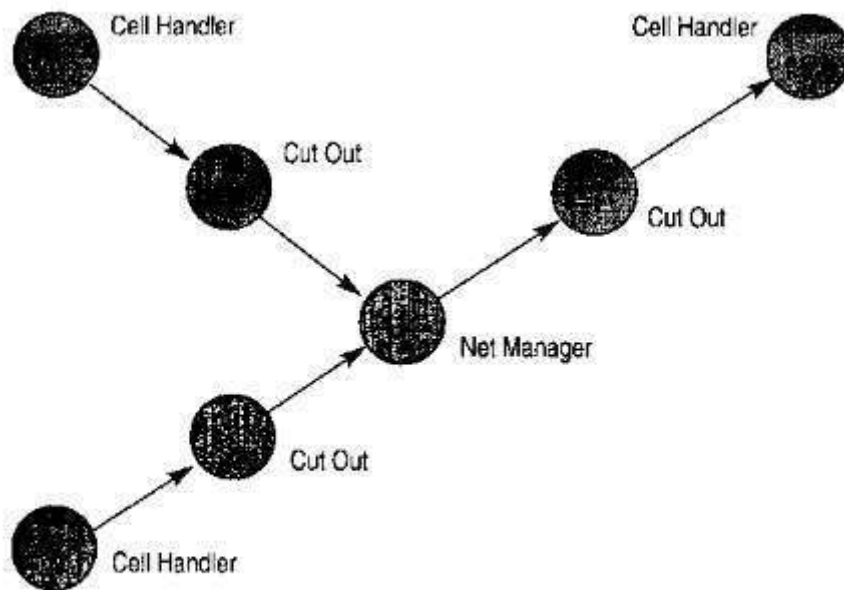

Figure 49.

All communications between cell handlers and the net manager is through the cutouts. All communications are clandestine. None of the individuals know each others real names or identities. Here is an example of a possible communications technique. The cell handler knows that he is to watch for a mark of a certain color on a certain day at a certain location. If that mark is present, he must pick up a message at a secret location. This message will be left at a hiding place that is known to him, such as behind a loose brick. This is known as a "dead letter drop." This message may contain instructions or a requirement for information. Often this message will contain instructions on the location and marking signal of the next dead drop. The person that drops the message may go to a distant location to casually observe the drop site to ensure that the message is picked up within a certain window of time and that the handler has not been followed. If it is not

picked up at the proper time, it is considered null and void. Sometimes cells can be given instructions or signals via a radio broadcast. The cell member would listen for a code at a certain time on a known frequency. Often, it may be necessary to pass items between the cell and the net manager. Instructions may be given at a drop to meet someone at a certain place at a specific time. Instructions would include "all clear" and authentication codes. The information is passed between the operatives in a way that raises no suspicion. Usually, the person that takes on the function of cutout in this situation is not the usual cutout but a courier whom the cell handler has never seen. To illustrate this, the following example is submitted. The cell handler has become aware of enemy plans that will directly affect resistance operations. The standard operating instructions for the network provides for priority communications between the handler and net manager by a prearranged signal. This is a clandestine signal that is monitored perhaps daily to tell either party that a priority communication is required. In order to keep it secret, this means is rarely used. A message is passed from the handler to a courier acting as a cutout after observing proper authentication signals and codes. The exchange may be monitored by the net manager from a distance to ensure that the transfer is not compromised in any obvious way. If the net manager feels that the transfer was not compromised, he leaves a signal to indicate to the courier that he can transfer the message. If the signal is not present, the courier goes to an alternate signal location at a designated time to look for the signal. Upon recognizing the all-clear signal, the courier leaves a signal at another location to indicate that he feels that he has not been compromised and has recognized the all clear left by the net manager. The courier then performs the transfer to the net manager using a preplanned technique such as dead letter drop or face-to-face exchange using proper recognition codes and authentication phrases. From the time this operation is started, all personnel use evasive techniques to determine if they are being followed and to prevent it.

Individuals act casual and do not take actions that would raise suspicions, even if they are being watched. Any signal left should be made in a preplanned way that would be difficult to recognize if someone were watching. For example, while palming a small piece of specific colored crayon, the person leaving the mark stops to pull up his sock. While doing so, he rests his hand against the wall to balance himself, leaving a small colored mark as the predesignated signal. Similarly, when an individual looks to see if a signal has been left, it should not be obvious. This procedure takes time, because this type of operation should not be hurried. If a member of the underground is compromised, he can be captured at best. At worst, he will not know of the compromise, and others could be compromised. This can make the cell ineffective for an extended period.

The groups should be intimate and only accept recruits who are slowly converted into the cause. Already converted people on the internet are sent off on their own to begin such projects of inviting slowly converted individuals. This is to maximize security. People who are seem willing to join and execute operations immediately may be sincere or infiltrators who would want the guerrilla imprisoned or worse. Online communities are also notorious for attracting people with no abilities. Such people are to be avoided as they will corrupt the movement and give no useful work.

Here is the cycle:

1. Person A is converted to the cause on the internet.
2. Person A slowly introduces the ideas to person B and person C.

3. Person B is disinterested but person C is interested and is converted to the cause.
4. Person A and C slowly build up a bond. A group is built.
5. Repeat with person D, person E and so on.

Conversion

Conversion is a slow process and might not work out for everyone. It is important to be patient. It is especially advised to be educated in the ideology and to be charming. There are many ways to improve your character and thousands of websites, videos and books about how to do it. Learn about techniques used in debates and speeches to maximize the effectiveness of the ideology. But remember to sow the seeds slowly. An individual who has been educated by the status quo will be shocked if you go balls-to-the-wall. Slowly reflect on news stories, historical events and personal experiences through an ideological lens. The ideology should not be just an ideology. It should be a philosophy: a way of life.

The target is best if he fits this profile: male, 18-25 years old, alienated, full of potential and generally mentally well. Most guerrillas are male because men are by nature are stronger and more willing to defend their "tribe" which could be the guerrilla group in a way. This drive can be solidified with brotherhood. Young men 18-25 years old are often the most aggressive and willing to rebel. Teenagers are also aggressive and rebellious but are immature and dependent by law on their family. They are not as autonomous as adults. Teenagers also quickly change their mind on things. A alienated man will have a drive to revolt against the status quo especially if he is full of potential and mentally well. Do target individuals rooted in reality.

Women should not be targeted as potential guerrillas pre-revolution. Women can however be allies pre-revolution and help start families and communities. They could be guerrillas during the revolution as warfare will have been normalized enough: see women in the Kurdish YPG and Israeli IDF. Transsexuals should be avoided for many reasons. Male (and masculine) homosexuals and bisexuals may be allowed in if they are otherwise fit for service in the guerrilla forces.

Front Organization

The development and control of 'front' organizations is carried out through internal subjective (concealed) control, through group meetings of the 'internal cadres,' and by calculating the time needed for the combination of these two elements to be applied to the masses.

Established citizens--doctors, attorneys, businessmen, teachers, etc.--will be recruited initially as "Social Crusaders" in typically "innocuous" movements in the area of operations. When their 'involvement' with the clandestine organization is revealed to them, this exerts psychological pressure on them so that they can be used as "internal cadres" in groups to which they already belong or groups which they could join.

a gradual and skillful process, they will receive instruction in persuasion techniques for the control of target groups which will support our revolution. A system for the control of cells isolates individuals from one another, and at the appropriate moment, their influence is used to fuse the groups together into a united national front.

The merging of organizations recognized by the government, such as associations and other groups, through internal subjective control occurs in the final stages of the operation, in close relationship with mass meetings.

When armed guerrilla action has spread sufficiently, large-scale armed propaganda missions will be conducted: propaganda teams will have clearly expressed open support for the institutions; the enemy system of target groups will be well infiltrated; and the preparation of these groups when mass meetings are held. Then internal cadres will have to start discussions toward the merging of forces into an organization--this organization shall be a front "facade" group of our movement.

Any other target group will be aware that other groups are evincing a greater hostility toward the government, the police, and the traditional legal bases of authority. The guerrilla cadres in that group, such as teachers, will cultivate this awareness by making comments like 'so and so, who is a farmer, said that members of his cooperative believe that the new economic policy is absurd, poorly planned and unfair to the farmers.

When awareness that other groups are hostile to the regime is increased, group discussions are held openly and our movement will be able to receive reports that most of its operations are equally shared. There will develop greater hostility toward the regime and the order to merge will come forth.

The incorporation into a "facade" organization is undertaken as follows:

1. Internal (cadres) from our movement will meet with others in positions of leadership, such as presidents, leaders, and others, in organized meetings presided by the organization's chief of our movement. Two or three escorts may assist the guerrilla cadre if it becomes necessary.
2. Following the meeting a joint communique is to be issued, announcing the creation of the 'facade' organization, including names and signatures of participants and names of the organizations they represent.
3. Following the issuance of this communique, mass meetings should be initiated, whose aim must be the destruction of the status-quo control system.

Infiltration of guerrilla cadres

Infiltration of guerrilla cadres (either a member of our own movement or an outside member) in trade unions, youth movements, peasant organizations, etc., preconditioning these groups to act among the masses, where they will have to proselytize in a clandestine fashion for the insurrectional struggle.

Our psychological war team must develop in advance a hostile mental attitude among the target groups, so that at the given moment they can turn their anger into violence, demanding their rights taken away by the regime. These preconditioning-campaigns will be aimed at the political parties, professional organizations, students, workers, the unemployed masses, and at any other vulnerable or recruitable sector of society; this also includes the popular masses and sympathizers to our movement.

The principal objective of a preconditioning campaign is to create a negative 'image' of the common enemy, for example:

- To describe managers of international mega-corporations as 'slave drivers' in their treatment of the personnel.

- To say that the police mistreat the people the same as the soviet union or any other totalitarian regime did.
- To say that the officials of the government are lackeys of the status quo combine. Our psychological warfare cadres will create temporary compulsive obsessions in mass concentrations or group meetings by hammering on specific or selective topics; in informal conversations by expressing discontent; writing editorials for newspapers and radio, aimed at conditioning the people's thinking for the decisive moment, at which time they will turn to general violence.
- To facilitate the preconditioning of the masses we must repeat phrases frequently to let the people know, for instance, that:
 1. The taxes they pay to the government do not benefit the people at all, and that, on the contrary, they are used in the form of exploitation and to enrich government officials.
 2. Make evident to them that the people have been turned into slaves, and are being exploited by privileged political and military groups.
 3. That foreign advisors and their advisory programs are in actuality 'interventionists' in our country, that they direct the exploitation of the nation in accordance with the objectives of the Global capitalists and marxists so as to turn our people into slaves of the hammer and sickle or the banking clans' greedy machine.

The control of mass meetings in support of guerrilla warfare is carried out internally through a covert commando element, bodyguards, messengers, shock troops (incident initiators), poster carriers (also used to give signals), and slogan shouters, all under the control of the external commando element.

Mixing members of the struggle with participants in the demonstration will give the appearance of a spontaneous, undirected manifestation, which will be used by the agitators of the struggle in order to control the behavior of the masses.

Recruitment

Note: This is for when the guerrilla organization begins to grow larger and the movement more influential.

The initial recruitment to the movement if involuntary will be carried out by means of several "private" consultations with a cadre (without the recruit realizing that he is speaking to one of our members). Afterwards, the recruit will be informed that he or she is already in the movement, and will be running the risk of the government police if he or she does not cooperate.

When the guerrillas carry out missions of armed propaganda and a program of regular visits to the towns by Armed Propaganda Teams, these contacts will provide to the commanders the names and places of persons that can be recruited. Voluntary recruitment is effected by means of visits from guerrilla leaders or political cadres.

After a chain of voluntary recruitments has been developed, and their reliability has been established by completing some minor missions, they will be instructed on widening the chain by recruiting in specific target groups, according to the following procedure:

1. From among their acquaintances or through observation of the target groups— political parties, labor unions, youth groups, farming organizations, etc.—find out the personal habits, preferences and aversions, as well as the weaknesses, of the recruitable individuals.
2. Make an approach through an acquaintance, and if possible, develop a friendship, attracting (the individual) by means of his preferences or weaknesses; possibly by inviting him to lunch in a restaurant he likes, or to have a drink in his favorite bar, or an invitation to dinner in a place he prefers.

Recruitment should follow one of the following patterns:

1. If in an informal conversation the target seems susceptible to voluntary recruitment based on his beliefs and personal values, etc., the political cadre assigned to carry out recruitments will be notified. The original contact will indicate to the assigned cadre in detail all that he knows about the possible recruit, and the style of persuasion that should be used, and introduce the two.
2. If the target does not seem susceptible to voluntary recruitment, meetings which will seem accidental can be arranged with guerrilla leaders of political cadre (unknown to the target until then). The meeting will be done so that "other persons" know that the target was there, because they saw him arrive at a certain house, or seated at a table in a certain bar, or even seated on a park bench. The target is then confronted with the fact of his participation in the insurrection and he will also be told that if he fails to cooperate or to carry out future orders, he will expose himself to reprisals on the part of the regime's police or military.
3. Notification of the police, informing on a target who refuses to join the guerrillas, can be easily carried out, when it is necessary, by means of a letter with false declarations by citizens who are not implicated in the movement. Care must be taken so that the person who recruited him covertly should not be uncovered.
4. With the completion of clandestine missions for the movement, the involvement and commitment of each recruit will gradually become greater, and his confidence will increase. This should be a gradual process, in order to prevent confessions from frightened individuals to whom very difficult or dangerous missions have been assigned too early. Using this recruiting technique, our guerrilla can successfully infiltrate any key target group in the regime, in order to improve internal control over the enemy structure.

Established citizens - such as doctors, lawyers, businessmen, landowners, minor state officials, etc. - will be recruited into the movement and used for the subjective internal control of groups and associations to which they belong or may belong. Once the recruitment/involvement has been accomplished, and has progressed to a point of reliability which permits specific instructions to be given to the cadre in order to begin to influence their groups, directions will be given to them to carry out the following:

1. The procedure is simple and requires only a basic knowledge of Socratic dialectics: that is the knowledge which is inherent to another person or to the established position of a group; some topic, come word or thought related to the goal 'of persuasion of our person in charge of recruitment.
2. The member then should introduce this topic, work or thought into the discussions or meetings of the target group, by means of a casual remark, which will improve the focus of other group members in relation to it (the topic, etc.).

Specific examples are:

- Groups of economic interests are motivated by profit, and generally feel that the system prevents the use of their abilities in this effort in some way, taxes, import/export tariffs, transportation costs, etc. The cadre in charge (of recruitment) will make this feeling of frustration increase in later conversations.
- Political aspirants, especially if they are not successful, feel that the system discriminates against them unjustly by limiting their capabilities, because the status quo rigs elections in favor of special interests. The cadre should channel political discussions towards this frustration.
- Social-intellectual critics (such as professors, teachers, priests, missionaries, etc.) generally feel that the government ignores their valid criticisms and unjustly censors their commentaries. especially in a revolutionary situation. This can be easily demonstrated by the guerrilla member as an injustice of the system, in meetings and discussions.
- In all of the target groups, after the frustrations have been established, the hostility towards the obstacles to their aspirations will gradually be transferred toward the present regime and its system of repression.

The guerrilla cadre working among the target groups should always maintain a low-key presence, so that the development of hostile feelings towards the status quo will seem to come spontaneously from the group's members, and not from the cadre's suggestions. This is subjective internal control. The anti-government hostility should be generalized and not necessarily in our favor. If a group develops a favorable feeling towards us it can be used. But the main goal is to prearrange the target groups to be included latter in the mass organizations for the Operation when some other activities have been developed successfully.

Equipment

If you have the luxury of extensive access to firearms and ammunition, then make good use of your situation by stockpiling ammunition and guns for your fellow bloodbrothers. It is also recommended to start accumulating and studying military manuals about weapons you may encounter in the field, i.e. Light Anti-tank Weapons, TOW and Stinger missiles, various machineguns.

Urban guerrillas will usually be more lightly armored than their rural counterparts. They may even wear civilian clothing with only a balaclava or arm binding to set them apart. Their gear and tools too are usually minimal: only what is necessary for the mission at hand. If it involves expropriation of assets, then lockpicking tools, crowbars, wire cutters and saws are needed. If it is a patrol or scouting mission then communication and photography equipment is useful. There is no standard gear or tool list for the urban guerrilla other than at least one loaded firearm.

Every guerrilla needs:

- Boots (two pair)
- Socks (wool and cotton, six pair of each)
- Gloves (leather with wool liners, two pair)
- Underwear (several pair)
- Combat fatigues (olive drab or woodland camouflage, four sets)
- Waterproof poncho and liner
- Field jacket and liner

- Blanket or Sleeping bag suitable for weather conditions
- Sleeping pad
- Long underwear (two pair)
- Kevlar Helmet or steel pot with liner
- Beret or boonie hat
- Camo gear (paint, veil, mask or burnt cork)
- Pistol belt
- Suspenders for pistol belt
- Signal mirror
- Radio (Two way and AM/FM) with extra batteries
- Rope (25 feet)
- Alice pack (medium or large)
- Rifle or shotgun
- Pistol (sidearm)
- Holster
- Rucksack or pack
- Haversack or hunting pouch
- Canvas piece
- Tent or Shelter Half
- Webbing or belt
- Gas mask
- Ammunition pouches (at least two)
- Ammunition (minimum 1000 rounds per weapon) Mess Kit
- Two canteens with insulated covers
- Canteen cup
- Butterdish
- Cutlery
- Hunting knife or dagger
- Compass
- Lighter, matches, magnifying lens, firestone
- Weapons cleaning kit
- Sewing kit
- Personal hygiene kit
- Wash and cleaning kit
- Pencil and paper
- Watch
- Camouflage net
- Mosquito (head) net
- Insect repellent
- Water purification tablets
- Toilet paper
- Utility knife (Swiss army knife)
- Combat knife

First-aid equipment:

- Small first-aid kit with basic first-aid instructions
- Bandage pack (on the body)
- Gauze
- Quinine
- Aspirin

- Anti-biotics
- Vitamin Drops
- Tannalbin
- Amphetamines
- throat lozenge
- Water purification tablets
- Salt tablets
- Antimalarials
- Gelusil
- Tetracaine

Other drugs with similar effect (other anesthetics than tetracaine or other anti-acids than gelusil) may be used if the medical research is done beforehand.

Each group needs:

- Binoculars
- Flashlights with extra batteries
- Electrical tape (black)
- Mapcase and maps
- Calendar with rising and setting times of sun and moon
- Edible plants and animal guide/survivalism guide
- Shovel or entrenching tool
- Claw axe
- Saw
- Insulated pliers and wire cutters
- Collapsible stoves for solid fuel
- Whistle

Diplomacy

Diplomatic relationships will have to be considered during the revolution. This is a compromise. For example: who will you get oil from if you revolted against the USA? The guerrillas then must have good relations to other oil rich forces such as Iran, Russia or China. There are some materials that the guerrilla can not acquire from the homeland such as for example coffee and chocolate which grows in jungles. Other materials such as reliable foreign cars will also be needed (see the Iran car crisis). If the guerrillas warred against a powerful nation it may put sanctions against the guerrillas as with the USA did against Cuba so a diplomatic ally that will supply the guerrillas with resources is important.

Diplomacy will also allow for the possibility of the guerrilla rule to be recognized and enforced both de facto and de jure. However the recognition will only be received from the nations to which there are diplomatic ties and not the UN. De facto guerrilla powers such as Somaliland, Rojava and the Gaza strip are de facto powers but not de jure. Even if guerrillas take power over the government the power will not be considered de jure. The Taliban is not considered de jure even if they established a new functional government in Afghanistan. De jure recognition will allow for the guerrillas to participate in wider world politics. The process is slow and full of legal work.

CHAPTER XXII: GUERRILLA TACTICS

Note: This section was largely written by Carlos Marighella.

The tactics of the urban guerrilla have the following characteristics:

1. It is an aggressive tactic, or, in other words, it has an offensive character. As is well known, defensive action means death for us. Since we are inferior to the enemy in firepower, and have neither his resources nor his power base, we cannot defend ourselves against an offensive or a concentrated attack by the "gorillas". That is the reason why our urban technique can never be permanent, can never defend a fixed base nor remain in any one spot waiting to repel the circle of repression.
2. It is a tactic of attack and rapid withdrawal, by which we preserve our forces.
3. It is a tactic that aims at the development of urban guerrilla warfare, whose function will be to wear out, demoralize and distract the enemy forces, permitting the emergence and survival of rural guerrilla warfare, which is destined to play the decisive role in the revolutionary war.

The dynamics of urban guerrilla warfare lie in the guerrilla's violent clash with the military and police forces of the dictatorship. In this conflict, the police have superiority. The urban guerrilla has inferior forces. The paradox is that the urban guerrilla is nevertheless the attacker.

The military and police forces, for their part, respond to the conflict by mobilizing and concentrating greatly superior forces in the pursuit and destruction of the urban guerrilla. The guerrilla can only avoid defeat if he depends on the initial advantages he has and knows how to exploit them to the end, to compensate for his weakness and lack of material.

The initial advantages are:

1. He must take the enemy by surprise.
2. He must know the terrain of the encounter.
3. He must have greater mobility and speed than the police and other repressive forces.
4. His information service must be better than the enemy's.
5. He must be in command of the situation, and demonstrate a decisiveness so great that everyone on our side is inspired and never thinks of hesitating, while on the other side the enemy is stunned and incapable of acting.

To compensate for his general weakness and shortage of weapons compared to the enemy, the urban guerrilla uses surprise. The enemy has no way to combat surprise and becomes confused and is destroyed.

When urban guerrilla warfare broke out in Brazil, experience proved that surprise was essential to the success of any guerrilla operation. The technique of surprise is based upon four essential requirements:

1. We know the situation of the enemy we are going to attack, usually by means of precise information and meticulous observation, while the enemy does not know he is going to be attacked and knows nothing about the attackers.
2. We know the strength of the enemy we are going to attack, and the enemy knows nothing about our strength.
3. Attacking by surprise, we save and conserve our forces, while the enemy is unable to do the same, and is left at the mercy of events.
4. We determine the time and place of the attack, fix its duration and establish its objectives. The enemy remains ignorant of all of this information.

To insure a mobility and speed that the police cannot match, the urban guerrilla needs the following:

1. Vehicles.
2. Knowledge of the terrain.
3. A disruption or suspension of enemy transport and communications.
4. Light weapons.

By carefully carrying out operations that last only a few moments, and leaving the site in mechanized vehicles, the urban guerrilla beats a rapid retreat, escaping capture.

The urban guerrilla must know the way in detail, and, in this manner, must go through the schedule ahead of time as a training, to avoid entering alleyways that have no exit, or running into traffic jams, or being stopped by the Transit Department's traffic signals.

The urban guerrilla must launch his operations far from the logistical centers of the police. A primary advantage of this method of operation is that it places us at a reasonable distance from the possibility of capture, which facilitates our evasion.

In addition to this necessary precaution, the urban guerrilla must be concerned with the enemy's communication system. The telephone is the primary target in preventing the enemy from access to information, by knocking out his communications systems.

Even if he knows about the guerrilla operation, the enemy depends on modern transportation for his logistics support, and his vehicles necessarily lose time carrying him through the heavy traffic of the large cities. It is clear that the tangled and treacherous traffic is a disadvantage for the enemy, as it would be for us if we were not ahead of him.

If we want to have a safe margin of security and be certain to leave no tracks for the future, we can adopt the following methods:

1. Deliberately intercept the police with other vehicles, or by seemingly casual inconveniences and accidents; but in this case the vehicles in question should neither be legal nor have real license numbers
2. Obstruct the roads with fallen trees, rocks, ditches, false traffic signs, dead ends or detours, or other clever methods
3. Place homemade mines in the way of the police; use gasoline or throw Molotov cocktails to set their vehicles on fire
4. Set off a burst of gunfire or throw hand grenades aimed at the motor, tires, and occupants of the cars and helicopters engaged in the pursuit

With the arrogance typical of the police and the military authorities, the enemy will come to fight us equipped with heavy guns and equipment, and with elaborate maneuvers by men armed to the teeth. The urban guerrilla must respond to this with light weapons that can be easily transported, so he can always escape with maximum speed without ever accepting open fighting. The urban guerrilla has no mission other than to attack and quickly withdraw. We would leave ourselves open to the most crushing defeats if we burdened ourselves with heavy weapons and with the tremendous weight of the ammunition necessary to use them, at the same time losing our precious gift of mobility.

The urban guerrilla's best ally is the terrain, and because this is so he must know it like the palm of his hand. To have the terrain as an ally means to know how to use with intelligence its unevenness, its high and low points, its turns, its irregularities, its fixed and secret passages, its abandoned areas, its thickets, etc., taking maximum advantage of all of this for the success of armed actions, escapes, retreats, covers, and hiding places. Impasses and narrow spots, gorges, streets under repair, police checkpoints, military zones and closed-off streets, the entrances and exits to tunnels and those that the enemy can close off, corners controlled or watched by the police, traffic lights and signals; all this must be thoroughly known and studied in order to avoid fatal errors.

Our problem is to get through and to know where and how to hide, leaving the enemy bewildered in areas he doesn't know. Being familiar with the avenues, streets, alleys, ins and outs, the corners of the urban centers, its paths and shortcuts, its empty lots, its underground passages, its pipes and sewer systems, the urban guerrilla safely crosses through the irregular and difficult terrain unfamiliar to the police, where the police can be surprised in a fatal ambush or trap at any moment.

Because he knows the terrain, the urban guerrilla can pass through it on foot, on bicycle, in a car, jeep or small truck, and never be trapped. Acting in small groups with only a few people, the guerrillas can rendezvous at a time and place determined beforehand, following up the initial attack with new guerrilla operations, or evading the police cordon and disorienting the enemy with their unexpected audacity.

It is an impossible problem for the police, in the labyrinthian terrain of the urban guerrilla, to catch someone they cannot see, to repress someone they cannot catch, and to close in on someone they cannot find.

Our experience is that the ideal guerrilla is one who operates in his own city and thoroughly knows its streets, its neighborhoods, its transit problems, and its other peculiarities. The guerrilla outsider, who comes to a city whose streets are unfamiliar to him, is a weak spot, and if he is assigned certain operations, he can endanger them. To avoid grave mistakes, it is necessary for him to get to know the layout of the streets.

Now will be introduced summarized explanations of different sort of guerrilla attacks.

Assaults are the armed attacks which we make to expropriate funds, liberate prisoners, capture explosives, weapons, and ammunition. Assaults can take place in broad daylight or at night. Daytime assaults are made when the objective cannot be achieved at any other hour, such as the transport of money by banks, which is not done at night. Night assault is usually the most advantageous for the guerrilla. The ideal is for all assaults to take place at night, when conditions for a surprise attack are most favorable and the

darkness facilitates escape and hides the identity of the participants. The urban guerrilla must prepare himself, nevertheless, to act under all conditions, daytime as well as night.

The assaults on businesses use the same tactics, because in every case the buildings represent a fixed target. Assaults on buildings are planned as guerrilla operations, varied according to whether they are against banks, a commercial enterprise, industries, military bases, commissaries, prisons, radio stations, warehouses for foreign firms, etc.

The assault on vehicles—money-carriers, armored vehicles, trains, ships, airplanes—are of another nature, since they are moving targets. The nature of the operation varies according to the situation and the circumstances—that is, whether the vehicle is stationary or moving. Armored cars, including military vehicles, are not immune to mines. Roadblocks, traps, ruses, interception by other vehicles, Molotov cocktails, shooting with heavy weapons, are efficient methods of assaulting vehicles. Heavy vehicles, grounded and anchored ships can be seized and their crews and guards overcome. Airplanes in flight can be hijacked by guerrilla action or by one person. Ships and trains in motion can be assaulted or captured by guerrilla operations in order to obtain weapons and ammunition or to prevent troop movements.

Raids and Penetrations are rapid attacks on establishments located in neighborhoods, or even in the center of the city, such as small military units, commissaries, hospitals, to cause trouble, seize weapons, punish and terrorize the enemy, take reprisals, or to rescue wounded prisoners or those hospitalized under police guard. Raids and penetrations are also made on garages and depots to destroy vehicles and damage installations, especially if they are North American firms and property. When they take place on certain stretches of highway or in certain distant neighborhoods, these raids can serve to force the enemy to move great numbers of troops, a totally useless effort since when they get there they will find nobody to fight. When they are carried out on certain houses, offices, archives or public offices, their purpose is to capture or search for secret papers and documents with which to denounce deals, compromises and the corruption of men in government, their dirty deals and criminal transactions. Raids and penetrations are most effective if they are carried out at night.

Ambushes are attacks, typified by surprise, when the enemy is trapped on the road or when he makes a police net surrounding a house or estate. A false alarm can bring the enemy to the spot, where he falls into a trap.

The principle object of the ambush is to capture enemy weapons and to punish him with death. Ambushes to halt passenger trains are for propaganda purposes, and, when they are troop trains, the object is to annihilate the enemy and seize his weapons. The urban guerrilla sniper is the kind of fighter specially suited for ambush, because he can hide easily in the irregularities of the terrain, on the roofs and the tops of buildings and apartments under construction. From windows and dark places, he can take careful aim at his chosen target.

Ambush has devastating effects on the enemy, leaving him unnerved, insecure and fearful.

Kidnapping is capturing and holding in a secret place a spy, political personality or a notorious and dangerous enemy of the revolutionary movement. Kidnapping is used to exchange for money or to kill the target in a secret spot. Ensure that the victim will

have no way of locating the secret spot or have any genetic evidence of the guerrilla on them. Exchange money in cryptocurrencies such as Monero. Drop off the victim at a random location and send communications of the drop-off afterwards.

The kidnapping of personalities who are well-known artists, sports figures or who are outstanding in some other field, but who have evidenced no political interest, can be a useful form of propaganda for the guerrillas, provided it occurs under special circumstances, and is handled so the public understands and sympathizes with it. The kidnappings of foreigners or visitors constitutes a form of protest against the penetration and domination of imperialism in our country.

Sabotage is a highly destructive type of attack using very few persons—and sometimes requiring only one—to accomplish the desired result. When the urban guerrilla uses sabotage, the first step is isolated sabotage. Then comes the step of dispersed and general sabotage, carried out by the population. Well-executed sabotage demands study, planning and careful action. A characteristic form of sabotage is explosion, using dynamite, fire or the placing of mines. A little sand, a trickle of any kind of combustible, a poor lubrication job, a screw removed, a short circuit, inserted pieces of wood or iron, can cause irreparable damage. The objective of sabotage is to hurt, to damage, to make useless and to destroy vital enemy points such as the following:

1. The economy of the country.
2. Agricultural or industrial production.
3. Transport and communication systems.
4. Military and police systems and their establishments and depots.
5. The firms and properties of enemies in the country.
6. Internet servers.

The urban guerrilla should endanger the economy of the country, particularly its economic and financial aspects, such as its domestic and foreign banking network, its exchange and credit systems, its tax collection system, etc.

Public offices, centers of government and government depots are easy targets for sabotage. Nor will it be easy to prevent the sabotage of agricultural and industrial production by the urban guerrilla, with his thorough knowledge of the local situation. Factory workers acting as urban guerrillas are excellent industrial saboteurs, since they, better than anyone, understand the industry, the factory, the machinery or the part most likely to destroy an entire operation, doing much more damage than a poorly-informed layman could do.

With respect to the enemy's transport and communications systems, beginning with railway traffic, it is necessary to attack them systematically with sabotage. The only caution is against causing death and injury to passengers, especially regular commuters on suburban and long-distance trains. Attacks on freight trains, rolling or stationary stock, stoppage of military transports and communications systems, these are the major objectives in this area. Sleepers can be damaged and pulled up, as can rails. A tunnel blocked by a barrier of explosives, or an obstruction caused by a derailed car, causes enormous harm.

The derailment of a train carrying fuel is of major damage to the enemy. So is bombing a railroad bridge. In a system where the size and weight of the rolling equipment is

enormous, it takes months for workers to repair or rebuild the destruction and damage. As for highways, they can be obstructed with trees, stationary vehicles, ditches, dislocation of barriers by explosives, and bridges destroyed by explosions. Ships can be damaged at anchor in seaports or riverports, or in the shipyards. Aircraft can be destroyed or damaged on the ground. Telephone and telegraph lines can be systematically damaged, their towers blown up, and their lines made useless.

Oil lines, fuel plants, depots for bombs and ammunition arsenals, military camps and bases must become targets for sabotage operations, while vehicles, army trucks and other military or police vehicles must be destroyed wherever they are found. The military and police repression centers and their specialized organs must also claim the attention of the guerrilla saboteur. Foreign firms and properties in the country, for their part, must become such frequent targets of sabotage that the volume of actions directed against them surpasses the total of all other actions against enemy vital points.

Terrorism is an action executed to spread terror against the enemy and which is capable of effecting irreparable loss against the enemy.

The terrorist act, apart from the apparent ease with which it can be carried out, is no different from other guerrilla acts and actions whose success depends on planning and determination. It is an action which the urban guerrilla must execute with the greatest calmness and determination. Although terrorism generally involves an explosion, there are cases in which it may be carried out through executions or the systematic burning of installations, properties, plantations, etc. It is essential to point out the importance of fires and the construction of incendiary devices such as gasoline bombs in the technique of guerrilla terrorism. Another thing is the importance of the material the urban guerrilla can persuade the people to expropriate in the moments of hunger and scarcity brought about by the greed of the big commercial interests. Terrorism is a weapon the revolutionary can never relinquish.

Ensure that the terrorist attack will have the desired consequences. Study The results of the St Nedelya Church assault and how an otherwise successful operation may cause the downfall of the guerrillas.

Rescue Of The Wounded

The problem of the wounded in urban guerrilla warfare merits special attention. During guerrilla operations in the urban area, it may happen that some comrade is wounded by the police. When a guerrilla in the firing group has a knowledge of first aid, he can do something for the wounded comrade on the spot. Under no circumstances should the wounded guerrilla be abandoned at the site of the battle or left in the enemy's hands. One of the precautions we must take is to set up first-aid courses for men and women, courses in which guerrillas can learn the rudiments of emergency medicine. The urban guerrilla who is a doctor, nurse, med student, pharmacist or who simply has had first aid training is a necessity in modern guerrilla struggle. A small manual of first aid for urban guerrillas, printed on mimeographed sheets, can also be produced by anyone who has enough knowledge.

In planning and carrying out an armed action, the urban guerrilla cannot forget the organization of medical support. This must be accomplished by means of a mobile or

motorized clinic. You can also set up a mobile first aid station. Another solution is to utilize the skills of a medical comrade, who waits with his bag of equipment in a designated house to which the wounded are brought. The ideal would be to have our own well-equipped clinic, but this is very expensive unless we expropriate all of our materials.

When all else fails, it is often necessary to resort to legal clinics, using armed force if necessary to force a doctor to treat our wounded. In the eventuality that we fall back upon blood banks to purchase blood or plasma, we must not use legal addresses and certainly no addresses where the wounded can really be found, since they are under our care and protection. Nor should we supply the addresses of those involved in the guerrilla organization to the hospitals and health care clinics where we may take them. Such caution is indispensable to covering our tracks. The houses in which the wounded stay cannot be known to anyone but the small group of comrades responsible for their care and transport. Sheets, bloody clothing, medicine and any other indications of treatment of comrades wounded in combat must be completely eliminated from any place they visit to receive treatment.

EXAMPLES

Note: This section is largely from the Werwolf combat manual translated by Lt. Michael C. Fagnon.

Ambush

Ambushes are one of the most promising means of waging guerrilla warfare. It is successful if the enemy is completely surprised. This can be achieved through careful planning and occasionally by skillful and quick improvisation. The smaller the operation, the easier its execution and the larger the possibility of avoiding failure. The approach to the ambush site must be unnoticed by the enemy and the population. Enemies met by chance must be killed inconspicuously and the guerrillas will have to withdraw if the enemy has managed to communicate back. Locals will be detained for the duration of the operation. Areas that are too obviously ambush sites are to be avoided, such as hollows and defiles. Positions in hedges, forest edges, cornfields, abandoned buildings, and gardens are well suited, especially if they offer possibilities of covered and concealed withdrawal. Patient, noiseless, and motionless waiting, often over a long period of time, are necessary when laying in ambush. Fire only opens up when the order or predetermined sign is given. In larger scale ambushes the advance party of the enemy should be allowed to pass in order to hit the more valuable targets following. If sufficient forces are available, a separate ambush may be set up for the expected advance party. Fire on the advance party may open up only after the main ambush is sprung. In smaller operations, only weaker enemy units, that can be completely destroyed, are ambushed.

Road ambush executed by a guerrilla group. These guerrillas open fire from the flanks. A machine gun or two guerrillas then fire on and along the road and especially into the road-ditches:

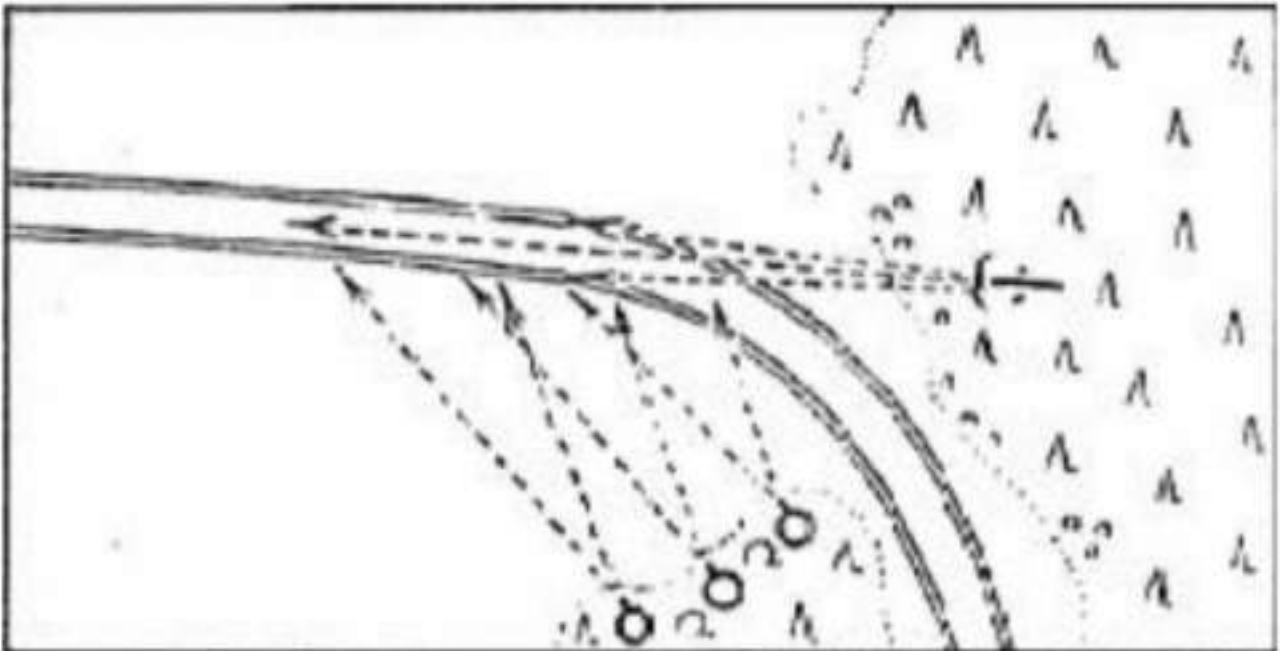

When ambushing motorized march columns, the front of the column must be forced to stop. This is done by using barriers or landmines. Only then is fire opened up on the vehicles. Road ambush executed by a guerrilla group:

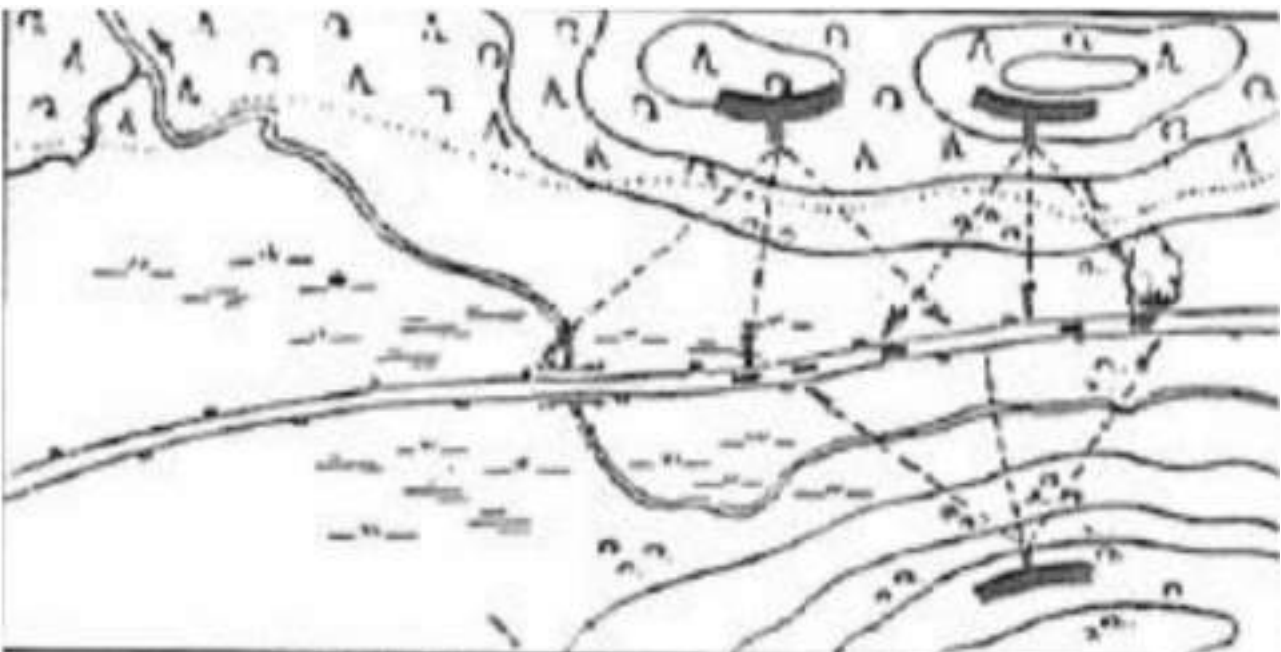

It is very advantageous if a small guerrilla unit can execute ambushes at various roads in short order. The enemy is thus deceived into thinking that the area is infested with guerrilla units. This forces the enemy to employ intensive security measures and ties up a larger number of his troops. When this had been achieved, the main effort of the guerrilla unit is shifted to other operations.

In ambushes against railways, the aim is to completely destroy as much material and enemy personnel as possible. Ambushes at railways are the task of larger guerrilla units. Smaller units may conduct demolition of rails and harassment by occasional gunfire.

Ambushes at downhill sections of the railway, and if possible, at a curve in connection with mines, are potentially worthwhile. Obstructions of longer durations are thus achieved. Railway ambush executed by a guerrilla platoon:

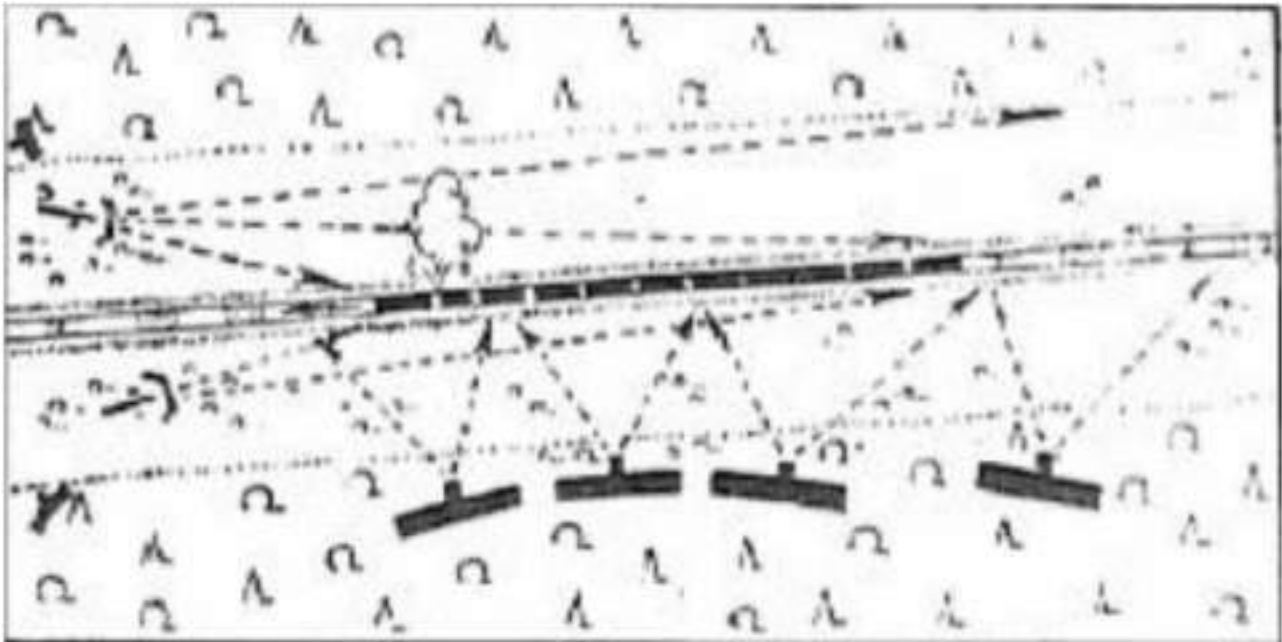

The ambush site should be away from fortifications, railway stations, and junctions as far as possible in order to avoid quick intervention by enemy security forces. Before the operation, intelligence and reconnaissance must concentrate on observing traffic density and protective measures, and who occupies the trains. During the operation, every guerrilla group and every single guerrilla must know exactly which task they have been given. After successful demolitions, the main impact of the gunfire must be directed against the carts which have been damaged least. Soldiers jumping out of the train must be shot at. In most cases a sign for the opening of fire is not necessary. It is opened up with the explosion of the landmines and the derailing of the train.

Raid

By fully exploiting the surprise element of a raid, it is possible to destroy an enemy that is superior in numbers or weapons. But if the raid, is unsuccessful, the operation often ends with high losses. If the enemy has a greater numerical superiority and fights with tactical skill, this can lead to the destruction of the guerrilla unit. Therefore, the decision to raid a superior or stronger enemy for example, a strongpoint, an enemy-occupied village, a staff, an airport, a camp, a railway station, should be considered very thoroughly. All circumstances must be checked. Reliable and secure routes of withdrawal in case of failure are a prerequisite. Only a leader with very good tactical training will be able to plan and conduct a raid or a well-defended larger target. Improvised raids at each possible opportunity are far more promising and much easier than attacks against such difficult targets. Even smaller guerrilla units can achieve good results. Such possibilities are given by chance when coming upon stragglers, wood collection parties, lone vehicles, staff on reconnaissance. They may also be sought or created: for example, by guerrillas hiding on a train and attacking the personnel on the locomotive. Or by burglarizing an apartment of a functionary and killing him, or attacking enemy duty offices, powerplants, outposts, that are

insufficiently secured. Skillful exploitation of such possibilities is the nature of guerrilla warfare. They offer good chances of success at little risk.

The raid of a larger target that is easy to defend and well secured, for example, an enemy-occupied dwelling, requires careful planning. Sufficient forces must also be available. This is only possible for larger guerrilla units. The aim is the destruction of the important enemy installations that are set up there, i.e. powerplants, fuel dumps, staffs etc. Thorough reconnaissance and intelligence must be conducted before planning. Strength, order of battle, armament and deployment of the enemy, his security and defense instructions, defensive installations, barriers, immediate security at the operation target, must be established in advance. In order to achieve a certain familiarity with the habits of the enemy, intelligence and reconnaissance must be conducted over a longer period of time. The help of the inhabitants is absolutely necessary. The combat plan is made according to the results of the intelligence and reconnaissance. It must primarily contain:

- a) Disposition of forces, combat means and equipment.
- b) Order of battle, allocation of security, relief assault and destroy groups.
- c) Assignment of the attack and destroy targets; instructions to the security and relief groups.
- d) Support on the part of the inhabitants or through guerrillas that have infiltrated.
- e) March and approach.
- f) Time of attack (if necessary, attack signal), watch word, recognition signals.
- g) Orders for withdrawal, immediate, secondary rendezvous points.
- h) Place of the leader during the attack.

The raid must start by surprise. The operation must be called off if the element of surprise is lost before the attack. The execution of a raid requires ruthless daring, energetic momentum and flexible improvising. Unexpected enemy defense must be broken. Surprise over the defenders must always be taken into consideration when raiding large objects, even after very thorough reconnaissance. The first, most important aim is the simultaneous destruction of all securing elements if this is possible. This is best achieved through guerrillas that have infiltrated into the village before the raid and attack the sentries or guards at a predetermined time or signal. The second aim is to seize the most important key positions before the alarmed defenders can man them and at the same time attack the barracks, where soldiers must be killed or contained. The most important rules of street combat must be observed: containing enemy resistance pockets through automatic weapons and mortars; avoiding open places and the middle of the street, using all possible cover that doors, corners, columns etc offer: smoking out houses that are stubbornly defended with hand grenades, if necessary, by demolitions or by burning them out. Only after successful paralyzation of the defenders can the planned destruction be executed.

Unexpected disturbances must be quieted by relief groups held in readiness. Unceasing reconnaissance during the execution of the raid must not be neglected. Elements must secure against neighboring villages. Streets, on which enemy reinforcements may arrive, must be sealed with barriers. After execution of the operational aims on which the raid was based, the groups withdraw in predetermined order after the signal to do so has been given. The relief groups that were held in readiness cover the withdrawal and disengagement from the enemy. Raids against weaker objects, train stations, depots and supply and industrial installations outside of enemy guarded settlements can be conducted by small guerrilla units. These must be planned according to the same basic tactical rules

that are valid for operations against strongly secured settlements. They promise easier success.

Disengagement

Skillful disengagements from the enemy and withdrawal after the execution of an operation, or when breaking off of an operation, is a tactical component of guerrilla warfare. Successful withdrawal secures the possibility of landing new surprising blows against the enemy. Withdrawal is the easiest if it is possible to completely destroy the enemy. This must be considered when choosing a target. Operations in which the guerrilla unit could be engaged in a long-lasting fight with superior enemy forces must be avoided. They do not fit the character of guerrilla warfare because they make withdrawal extremely difficult. Concealed routes of withdrawal must always be reconnoitered even if complete success can be expected. Orders for the withdrawal along these routes must be given in advance. The withdrawal from the enemy is conducted individually or in small groups. Rendezvous points and waiting times must always be ordered beforehand. In most cases, it is appropriate to determine an immediate RV (1-3 kilometers) with a short waiting time (1-3 hours) and a secondary RV with a longer waiting time (about 24 hours). The RV points should offer good cover and concealment, close observation posts, and concealed routes of withdrawal. It is absolutely necessary to secure the RV. The possibility that the enemy may find the RV by treason must always be considered. The rest area of the unit must therefore be away from the RV point. Only a guide remains at the RV. Groups must always be ordered to cover the withdrawal of the guerrilla unit with gunfire and barriers if the operation is conducted by a larger guerrilla unit.

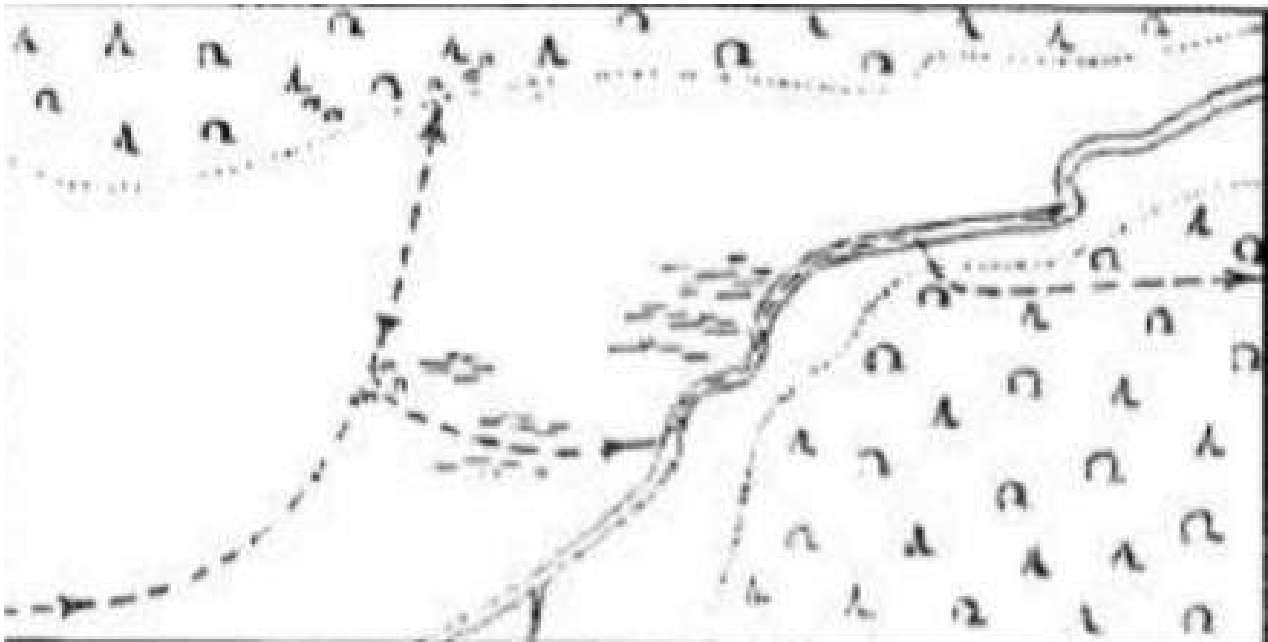

Backtracking and jumping off the track.

The guerrilla first went to the forest edge where he backtracked and jumped off his tracks into a group of bushes. He waded through a creek in order to further conceal his tracks.

It is best to give this task to the relief groups held in readiness. Pursuit from skillful scouts, tracking dogs, and trackers must always be expected. All possibilities to deceive them and conceal one's own tracks must be used. Such possibilities are: backtracking, cutting back, jumping off the track at suitable places, wading through streams. Setting up ambushes along the route of withdrawal now and then after a successful operation can lead to a new success and make further withdrawal easier.

Securing The Rest Area

Permanent camps can only be set up in very favorable terrain such as widespread forests, moorlands, and mountains. Care must be taken to camouflage the camp and the trails leading to it very well. A sure and safe measure is to only walk on hard, rocky underground. It must be avoided that beaten trails come into being. Care must be taken to secure the encamped guerrilla unit even where permanent camps cannot be erected. An effective security measure is to change the hideouts, which can be in isolated farms, cellars, ruins, hunting cabins, barns, dense pine groves, as often as possible. Immediate security is ensured by listening and observation posts. These are supplemented by a constant reconnaissance of the surrounding area. The best security is achieved with the help of the population. Women and children may be of useful service. Certain unsuspecting signals for warning and alarming the guerrilla unit must be ordered in advance. The same holds true for changing codewords and identification signals. Hideouts should have an emergency exit. Good protection can be achieved where it is possible to mine the approaches or set up booby traps using hand grenades with trip wires. Each guerrilla must always have his weapon within reach even when resting.

CHAPTER XXIII: SURVIVAL TIPS

The guerrilla must know how to manipulate the environment around himself when desperate in bad conditions.

Starting Fires

In many survival situations, the ability to start a fire can make the difference between living and dying. Fire can fulfill many needs. It can provide warmth and comfort. It not only cooks and preserves food, it also provides warmth in the form of heated food that saves calories our body normally uses to produce body heat. You can use fire to purify water, sterilize bandages, signal for rescue, and provide protection from animals. It can be a psychological boost by providing peace of mind and companionship. You can also use fire to produce tools and weapons.

Fire can cause problems, as well. The enemy can detect the smoke and light it produces. It can cause forest fires or destroy essential equipment. Fire can also cause burns carbon monoxide poisoning when used in shelters. Remember weigh your need for fire against your need to avoid enemy detection.

To build a fire, it helps to understand the basic principles of a fire. Fuel (in a non-gaseous state) does not burn directly. When you apply heat to a fuel, it produces a gas. This gas, combined with oxygen in the air, burns. Understanding the concept of the fire triangle is very important in constructing and maintaining a fire. The three sides of the triangle represent air, heat, and fuel. If you remove any of these, the fire will go out. The correct ratio of these components is very important for a fire to burn at its greatest capability. The only way to learn this ratio is to practice.

You will have to decide what site and arrangement to use. Before building a fire consider—

- The area (terrain and climate) in which you are operating.
- The materials and tools available.
- Time: how much time you have?
- Need: why you need a fire?
- Security: how close is the enemy?

Look for a dry spot that—

- Is protected from the wind.
- Is suitably placed in relation to your shelter (if any).
- Will concentrate the heat in the direction you desire.
- Has a supply of wood or other fuel available.

If you are in a wooded or brush-covered area, clear the brush and scrape the surface soil from the spot you have selected. Clear a circle at least 1 meter in diameter so there is little chance of the fire spreading. If time allows, construct a fire wall using logs or rocks. This wall will help to reflector direct the heat where you want it (Figure 7-1). It will also reduce flying sparks and cut down on the amount of wind blowing into the fire. However, you will need enough wind to keep the fire burning.

CAUTION: Do not use wet or porous rocks. The water could turn to steam when heated cause the rocks to 'explode'.

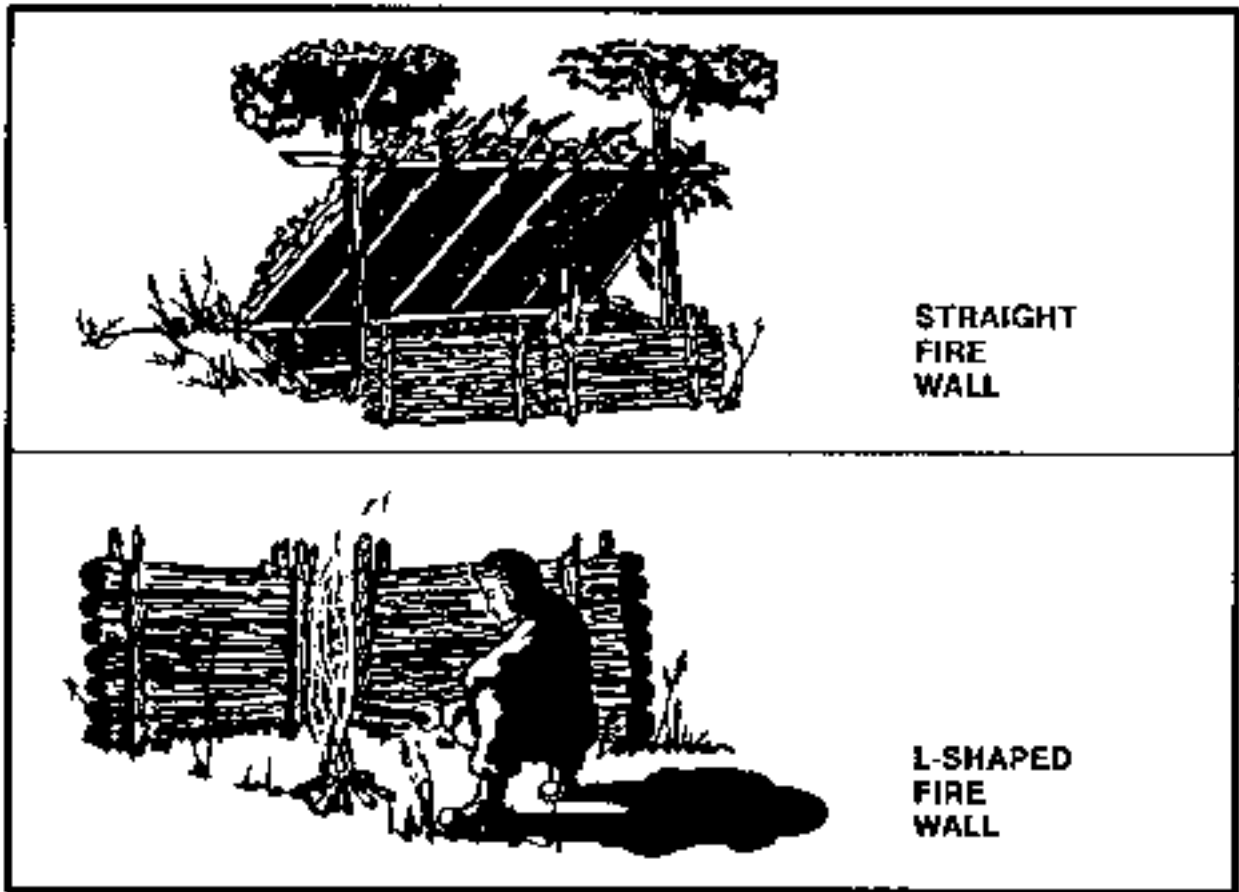

Figure 7-1. Types of fire walls.

In some situations, you may find that an underground fireplace will best meet your needs. It conceals the fire and serves well for cooking food. To make an underground fireplace or Dakota fire hole (Figure 7-2)—

- 1) Dig a hole in the ground.
- 2) On the upwind side of this hole, poke or dig a large connecting hole for ventilation.
- 3) Build your fire in the hole as illustrated.

If you are in a snow-covered area, use green logs to make a dry base for your fire. Trees with wrist-sized trunks are easily broken in extreme cold. Cut or break several green logs and lay them side by side on top of the snow. Add one or two more layers. Lay the top layer of logs opposite those below it.

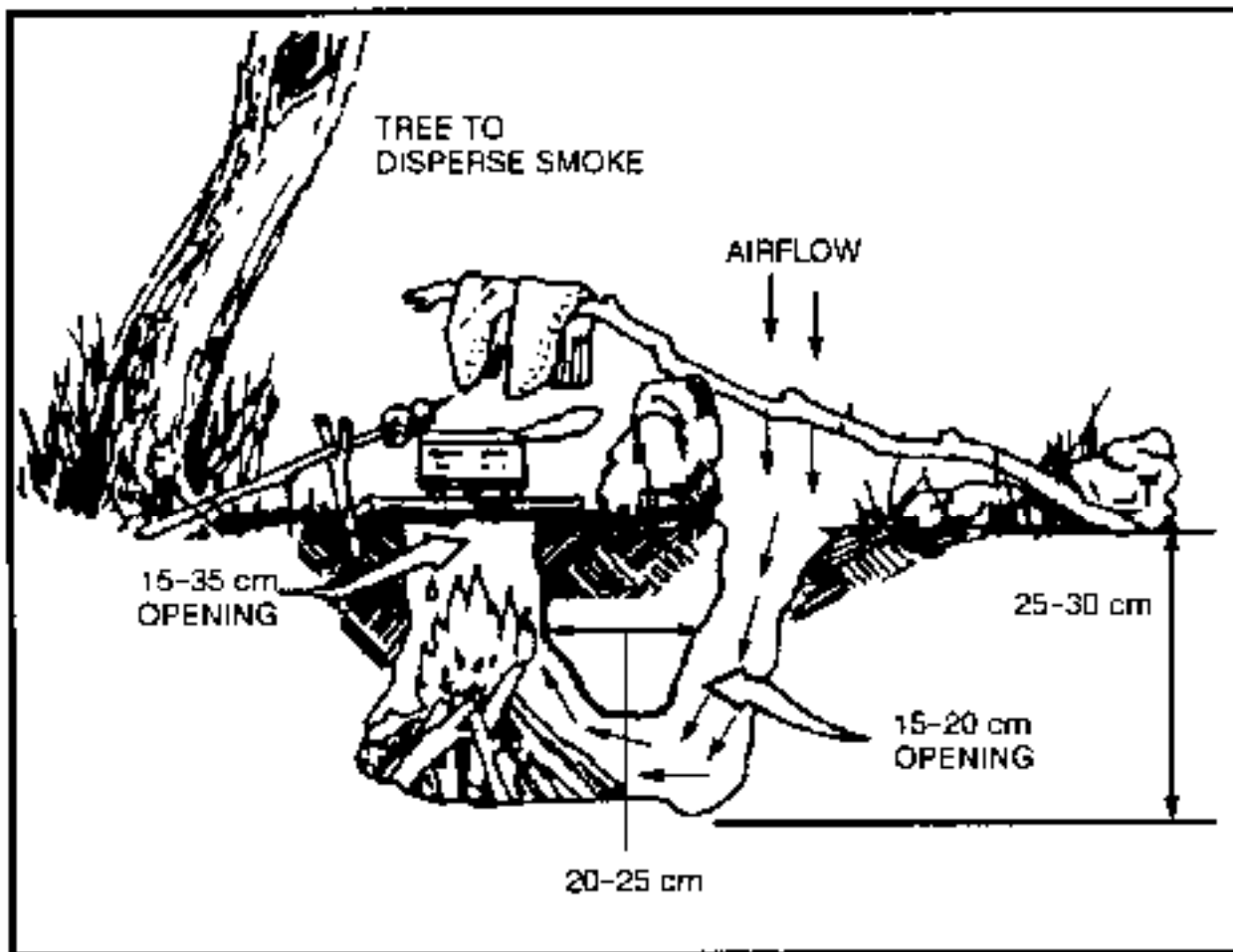

Figure 7-2. Dakota fire hole.

You need three types of materials to build a fire—tinder, kindling, and fuel.

Tinder is dry material that ignites with little heat—a spark starts a fire. The tinder must be absolutely dry to be sure just a spark will ignite it. If you only have a device that generates sparks, charred cloth will be almost essential. It holds a spark for long periods, allowing you to put tinder on the hot area to generate a small flame. You can make charred cloth by heating cotton cloth until it turns black, but does not burn. Once it is black, you must keep it in an airtight container to keep it dry. Prepare this cloth well in advance of any survival situation. Add it to your individual survival kit.

Kindling is readily combustible material that you add to the burning tinder. Again, this material should be absolutely dry to ensure rapid burning. Kindling increases the fire's temperature so that it will ignite less combustible material.

Fuel is less combustible material that burns slowly and steadily once ignited.

There are several methods for laying a fire, each of which has advantages. The situation you find yourself in will determine which fire to use.

Tepee: To make this fire (Figure 7-5), arrange the tinder and a few sticks of kindling in the shape of a tepee or cone. Light the center. As the tepee burns, the outside logs will fall inward, feeding the fire. This type of fire burns well even with wet wood.

Lean-To: To lay this fire (Figure 7-5), push a green stick into the ground at a 30-degree angle. Point the end of the stick in the direction of the wind. Place some tinder deep under this lean-to stick. Lean pieces of kindling against the lean-to stick. Light the tinder. As the kindling catches fire from the tinder, add more kindling.

Cross-Ditch: To use this method (Figure 7-5), scratch a cross about 30 centimeters in size in the ground. Dig the cross 7.5 centimeters deep. Put a large wad of tinder in the middle of the cross. Build a kindling pyramid above the tinder. The shallow ditch allows air to sweep under the tinder to provide a draft.

Pyramid: To lay this fire (Figure 7-5), place two small logs or branches parallel on the ground. Place a solid layer of small logs across the parallel logs. Add three or four more layers of logs or branches, each layer smaller than and at a right angle to the layer below it. Make a starter fire on top of the pyramid. As the starter fire burns, it will ignite the logs below it. This gives you a fire that burns downward, requiring no attention during the night.

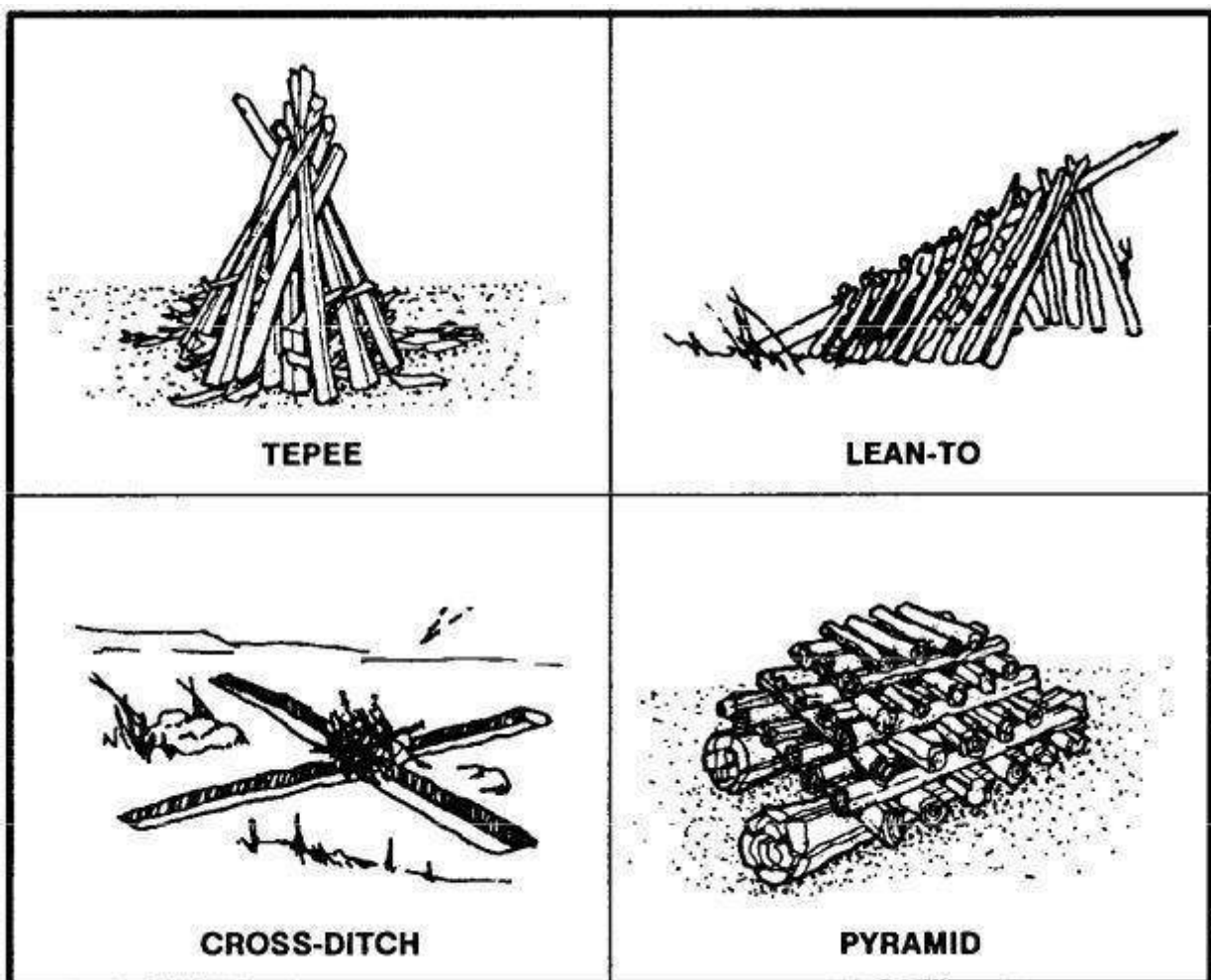

Figure 7-5. Methods for laying fires.

There are several other ways to lay a fire that are quite effective. Your situation and the material available in the area may make another method more suitable.

Now how to light a fire. Always light your fire from the upwind side. Make sure to lay your tinder, kindling, and fuel so that your fire will burn as long as you need it. Igniters provide the initial heat required to start the tinder burning. They fall into two categories: modern methods and primitive methods.

First the modern methods. Modern igniters use modern devices—items we normally think of to start a fire.

Lighter: A simple to use tool that requires lighter fluid to function. Choose one whose fuel can be replaced.

Matches: Make sure these matches are waterproof. Also, store them in a water-proof container along with a dependable striker pad.

Convex lens: Use this method only on bright, sunny days. The lens can come from binoculars, camera, telescopic sights, or magnifying glasses. Angle the lens to concentrate the sun's rays on the tinder. Hold the lens over the same spot until the tinder begins to smolder. Gently blow or fan the tinder into flame, and apply it to the fire lay.

Metal match: Place a flat, dry leaf under your tinder with a portion exposed. Place the tip of the metal match on the dry leaf, holding the metal match in one hand and a knife in the other. Scrape your knife against the metal match to produce sparks. The sparks will hit the tinder. When the tinder starts to smolder, proceed as above.

Battery: Use a battery to generate a spark. Use of this method depends on the type of battery available. Attach a wire to each terminal. Touch the ends of the bare wires together next to the tinder so the sparks will ignite it.

Gunpowder: Often, you will have ammunition with your equipment. If so, carefully extract the bullet from the shell casing, and use the gunpowder as tinder. A spark will ignite the powder. Be extremely careful when extracting the bullet from the case.

Now the primitive methods. Primitive igniters are those attributed to our early ancestors.

Flint and Steel: The direct spark method is the easiest of the primitive methods to use. The flint and steel method is the most reliable of the direct spark methods. Strike a flint or other hard, sharp-edged rock edge with a piece of carbon steel (stainless steel will not produce a good spark). This method requires a loose-jointed wrist and practice. When a spark has caught in the tinder, blow on it. The spark will spread and burst into flames.

Fire-Plow: The fire-plow (Figure 7-7) is a friction method of ignition. You rub a hardwood shaft against a softer wood base. To use this method, cut a straight groove in the base and plow the blunt tip of the shaft up and down the groove. The plowing action of the shaft pushes out small particles of wood fibers. Then, as you apply more pressure on each stroke, the friction ignites the wood particles.

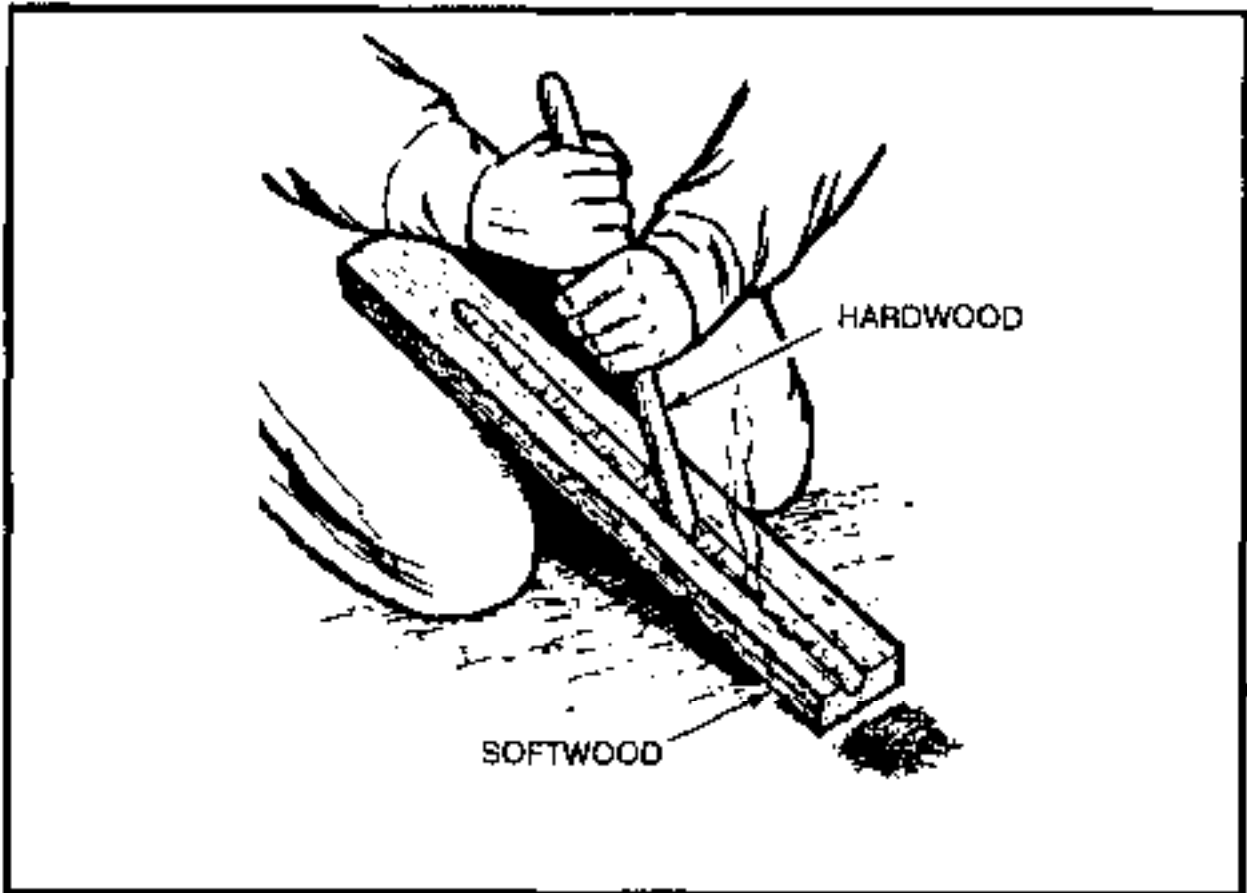

Figure 7-7. Fire-plow.

Bow Drill: The technique of starting a fire with a bow and drill (Figure 7-8) is simple, but you must exert much effort and be persistent to produce a fire. You need the following items to use this method:

- 1) Socket. The socket is an easily grasped stone or piece of hardwood or bone with a slight depression in one side. Use it to hold the drill in place and to apply downward pressure.
- 2) Drill. The drill should be a straight, seasoned hardwood stick about 2 centimeters in diameter and 25 centimeters long. The top end is round and the low end blunt (to produce more friction).
- 3) Fire board. Its size is up to you. A seasoned softwood board about 2.5 centimeters thick and 10 centimeters wide is preferable. Cut a depression about 2 centimeters from the edge on one side of the board. On the underside, make a V-shaped cut from the edge of the board to the depression.
- 4) Bow. The bow is a resilient, green stick about 2.5 centimeters in diameter and a string. The type of wood is not important. The bow-string can be any type of cordage. You tie the bowstring from one end of the bow to the other, without any slack.

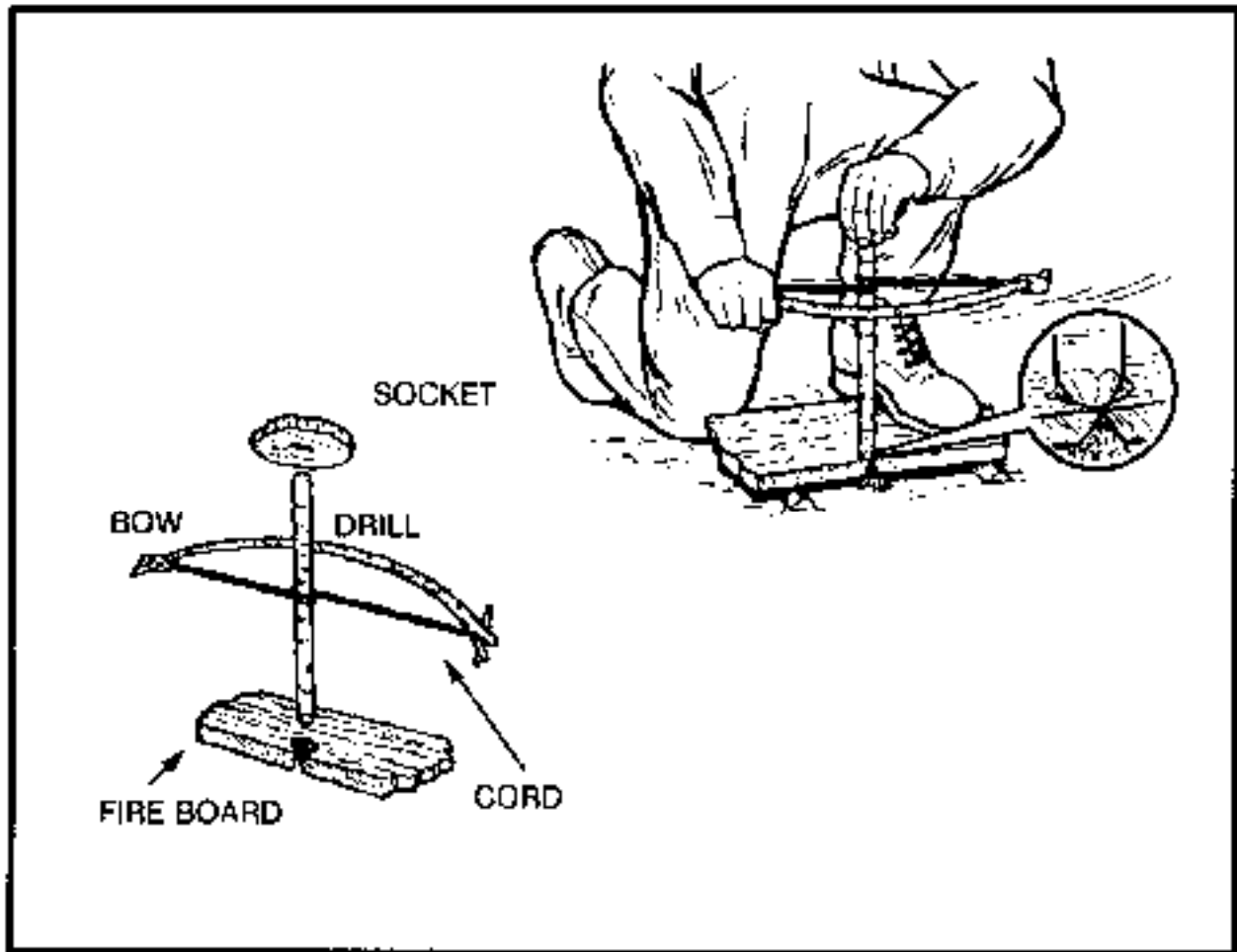

Figure 7-8. Bow and drill.

Helpful hints:

- Use nonaromatic seasoned hardwood for fuel, if possible.
- Collect kindling and tinder along the trail.
- Add insect repellent to the tinder.
- Keep the firewood dry.
- Dry damp firewood near the fire.
- Bank the fire to keep the coals alive overnight,
- Carry lighted punk, when possible.
- Be sure the fire is out before leaving camp.
- Do not select wood lying on the ground. It may appear to be dry but generally doesn't provide enough friction.

Filtering Water

Drinking unfiltered water in the wilderness can be very dangerous. If a water filter is unavailable, it must be improvised. What will be needed is a plastic bag, charcoal, sand, rocks, and the water that is to be filtered. If desperate, one's clothes could take the place of the plastic bag.

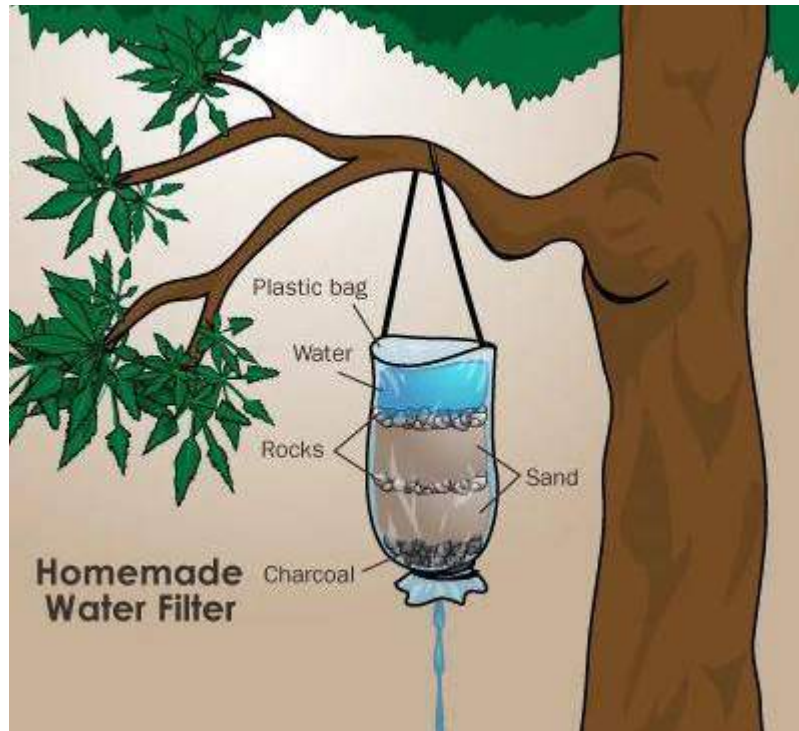

Sometimes not even these materials will be available. Avoid slow moving streams, puddles, ponds, and lakes. Water springs and large fast moving streams will be the safest to drink from. Beware of crocodiles and alligators if they are common in the region.

Emergency Rations

Note: Always carry a survivalism manual fit for the region the guerrilla is active in. Edible plants are different in different regions. Misidentification of edible plants may cause death.

Very young spruce shoots can be eaten raw or cooked. Edible mushrooms are a good food, also berries. Mushrooms become poisonous by frost, while many berry species become edible and palatable only by frost, such as mountain ash, barberry, and the like. Very nutritious and rich in vitamins are the bog cranberries, the buffalo cranberries, elderberries, rose hips.

Linden buds and most lichens (with the exception of the yellowish-colored, in particular the well-known gray-white, reindeer moss) are edible. The bitter substances contained in lichens are removed by several hours of soaking in water to which wood ash has been added. Then they can be cooked to an edible pulp. In an emergency, you can eat lichen after a thorough rinse also raw.

On the banks of rivers and lakes you can dig up the thick roots of calamari reeds, which can be eaten raw, or when cooked or baked they are quite edible.

Wood flour

A useful emergency food is wood flour. It is best obtained from young pines or birch stems in the following manner: Remove the upper bark layer; detach the moist, soft underlayer and cut it into small pieces; boil over several changes of water until the taste of the resin is sufficiently softened; dry thoroughly until the chips become tender and brittle; pound and grind.

The obtained yellowish-brownish bark meal can either be added to the rye or wheat flour for stretching or can also be enjoyed unmixed. To do this, make a dough with filtered water or milk, roll it out flat, cut it into small pancakes and then bake them on tin or iron pans.

Backpack

Saving a few ounces when packing up can be a lifesaver when you're 20 km in. Try to pack the fewest items, without skimping out on the necessities. Your packout is important. Everything you deem important will be carried by you for several kilometers on end. After a 20 km hike, a five pound difference in weight is going to feel like a twenty pound difference. If you're carrying everything on your back, try to minimize the amount of gear you're carrying.

When traveling in groups, this is easier. Have one man carry each type of item, i.e. one man carries a tent, another food, etc. Using communal gear can save 10 kg for each man.

Keep everything you might need at a moment's notice on your belt. Knives go on belts. Pistols go on belts. Axes and rifles can stay in the bag until you need to use them.

Keep a garbage bag handy to cover your bag when it gets rainy. If you have to travel through water, like crossing a river, then wrap your pack in two bags, leaving lots of air, and use it as a flotation device to get across. On that note, strip down if you're going to get wet. Better cold for twenty minutes than cold for twenty hours.

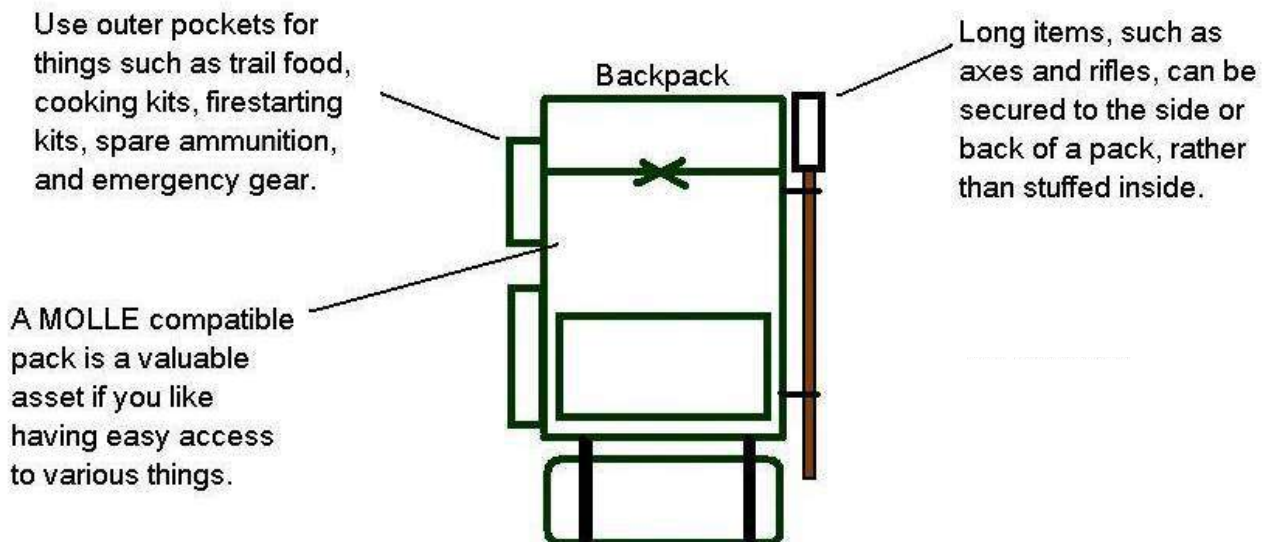

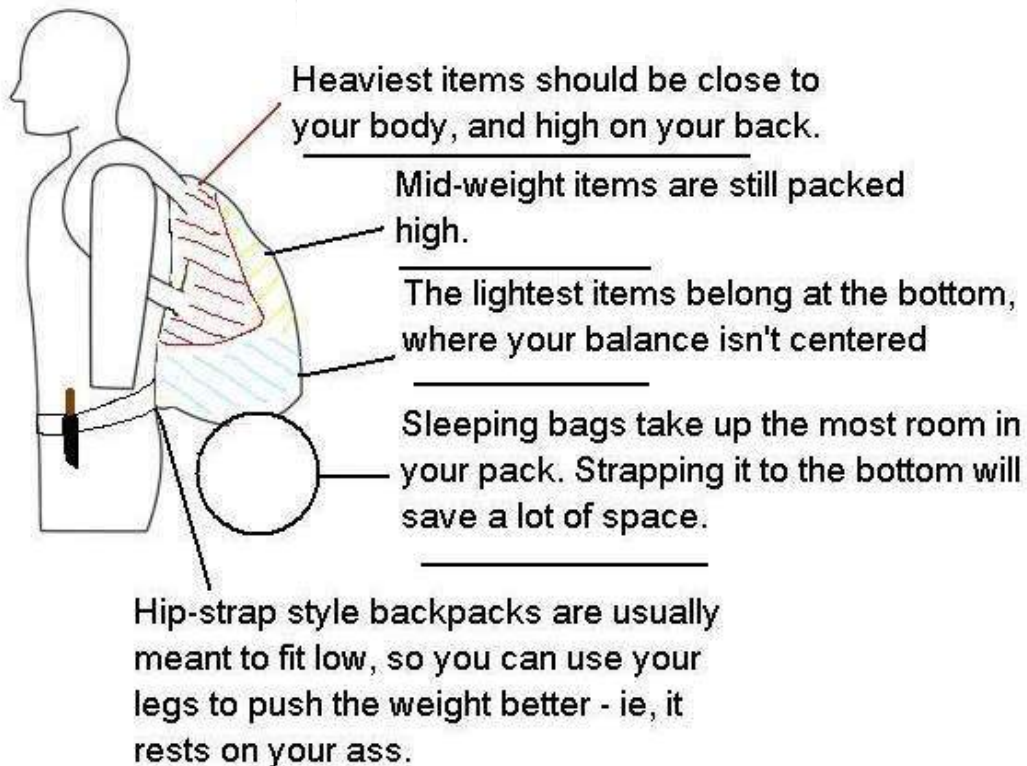

Shelter

A shelter can protect you from the sun, insects, wind, rain, snow, hot or cold temperatures, and enemy observation. It can give you a feeling of well-being. It can help you maintain your will to survive.

In some areas, your need for shelter may take precedence over your need for food and possibly even your need for water. For example, prolonged exposure to cold can cause excessive fatigue and weakness (exhaustion). An exhausted person may develop a "passive" outlook, thereby losing the will to survive.

The most common error in making a shelter is to make it too large. A shelter must be large enough to protect you. It must also be small enough to contain your body heat, especially in cold climates.

When you are in a survival situation and realize that shelter is a high priority, start looking for shelter as soon as possible. As you do so, remember what you will need at the site.

Two requisites are—

- It must contain material to make the type of shelter you need.
- It must be large enough and level enough for you to lie down comfortably.

When you consider these requisites, however, you cannot ignore your tactical situation or your safety. You must also consider whether the site—

- Provides concealment from enemy observation.
- Has camouflaged escape routes.
- Is suitable for signaling, if necessary.
- Provides protection against wild animals and rocks and dead trees that might fall.

- Is free from insects, reptiles, and poisonous plants.

You must also remember the problems that could arise in your environment. For instance—

- Avoid flash flood areas in foothills.
- Avoid avalanche or rockslide areas in mountainous terrain.
- Avoid sites near bodies of water that are below the high water mark.

In some areas, the season of the year has a strong bearing on the site you select. Ideal sites for a shelter differ in winter and summer. During cold winter months you will want a site that will protect you from the cold and wind, but will have a source of fuel and water. During summer months in the same area you will want a source of water, but you will want the site to be almost insect free.

When considering shelter site selection, use the word BLISS as a guide.

B - Blend in with the surroundings.

L - Low silhouette.

I - Irregular shape.

S - Small.

S - Secluded location.

When looking for a shelter site, keep in mind the type of shelter (protection) you need.

However, you must also consider—

- How much time and effort you need to build the shelter.
- If the shelter will adequately protect you from the elements (sun, wind, rain, snow).
- If you have the tools to build it. If not, can you make improvised tools?
- If you have the type and amount of materials needed to build it.

To answer these questions, you need to know how to make various types of shelters and what materials you need to make them.

Poncho Lean-To: It takes only a short time and minimal equipment to build this lean-to (Figure 5-1). You need a poncho, 2 to 3 meters of rope or parachute suspension line, three stakes about 30 centimeters long, and two trees or two poles 2 to 3 meters apart. Before selecting the trees you will use or the location of your poles, check the wind direction.

Ensure that the back of your lean-to will be into the wind. To make the lean-to—

- 1) Tie off the hood of the poncho. Pull the drawstring tight, roll the hood longways, fold it into thirds, and tie it off with the drawstring.
- 2) Cut the rope in half. On one long side of the poncho, tie half of the rope to the corner grommet. Tie the other half to the other corner grommet.
- 3) Attach a drip stick (about a 10-centimeter stick) to each rope about 2.5 centimeters from the grommet. These drip sticks will keep rainwater from running down the ropes into the lean-to. Tying strings (about 10 centimeters long) to each grommet along the poncho's top edge will allow the water to run to and down the line without dripping into the shelter.
- 4) Tie the ropes about waist high on the trees (uprights). Use a round turn and two half hitches with a quick-release knot.
- 5) Spread the poncho and anchor it to the ground, putting sharpened sticks through the grommets and into the ground.

If you plan to use the lean-to for more than one night, or you expect rain, make a center support for the lean-to. Make this support with a line. Attach one end of the line to the

poncho hood and the other end to an overhanging branch. Make sure there is no slack in the line. Another method is to place a stick upright under the center of the lean-to. This method, however, will restrict your space and movements in the shelter.

For additional protection from wind and rain, place some brush, your rucksack, or other equipment at the sides of the lean-to.

To reduce heat loss to the ground, place some type of insulating material, such as leaves or pine needles, inside your lean-to.

Note: When at rest, you lose as much as 80 percent of your body heat to the ground.

To increase your security from enemy observation, lower the lean-to's silhouette by making two changes. First, secure the support lines to the trees at knee height (not at waist height) using two knee-high sticks in the two center grommets (sides of lean-to). Second, angle the poncho to the ground, securing it with sharpened sticks, as above.

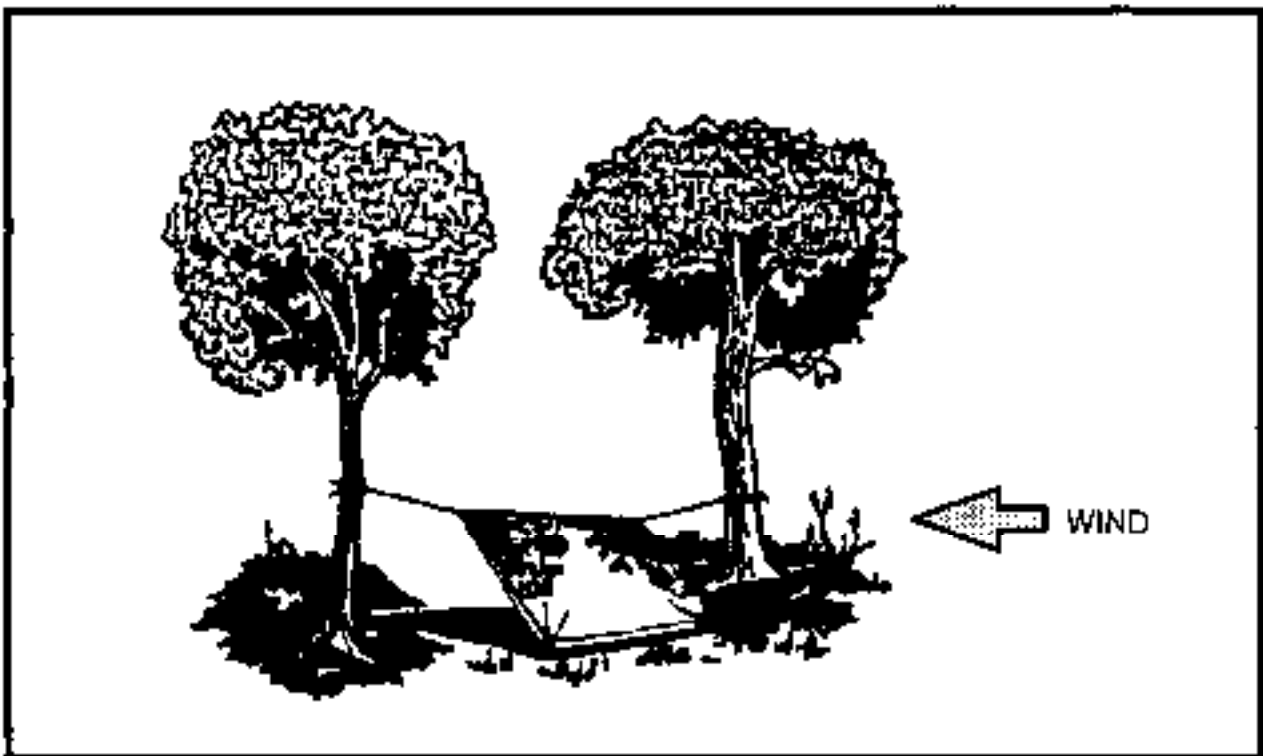

Figure 5-1. Poncho lean-to.

Poncho tent: This tent (Figure 5-2) provides a low silhouette. It also protects you from the elements on two sides. It has, however, less usable space and observation area than a lean-to, decreasing your reaction time to enemy detection. To make this tent, you need a poncho, two 1.5- to 2.5-meter ropes, six sharpened sticks about 30 centimeters long, and two trees 2 to 3 meters apart. To make the tent—

- 1) Tie off the poncho hood in the same way as the poncho lean-to.
- 2) Tie a 1.5- to 2.5-meter rope to the center grommet on each side of the poncho.
- 3) Tie the other ends of these ropes at about knee height to two trees 2 to 3 meters apart and stretch the poncho tight.

- 4) Draw one side of the poncho tight and secure it to the ground pushing sharpened sticks through the grommets.
- 5) Follow the same procedure on the other side.

The center of the tent (Figure 5-3). Use two 90- to 120-centimeter-long sticks, one with a forked end, to form the A-frame. Tie the hood's draw-string to the A-frame to support the center of the tent.

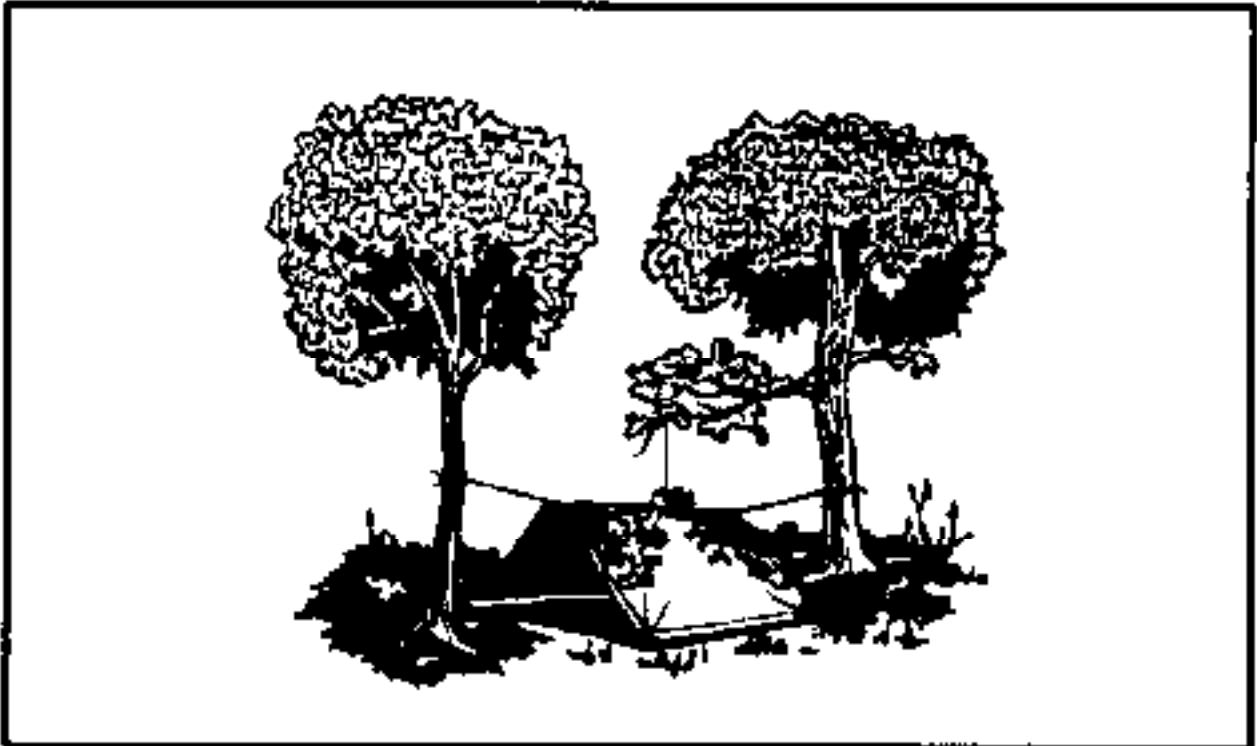

Figure 5-2. Poncho tent using overhanging branch.

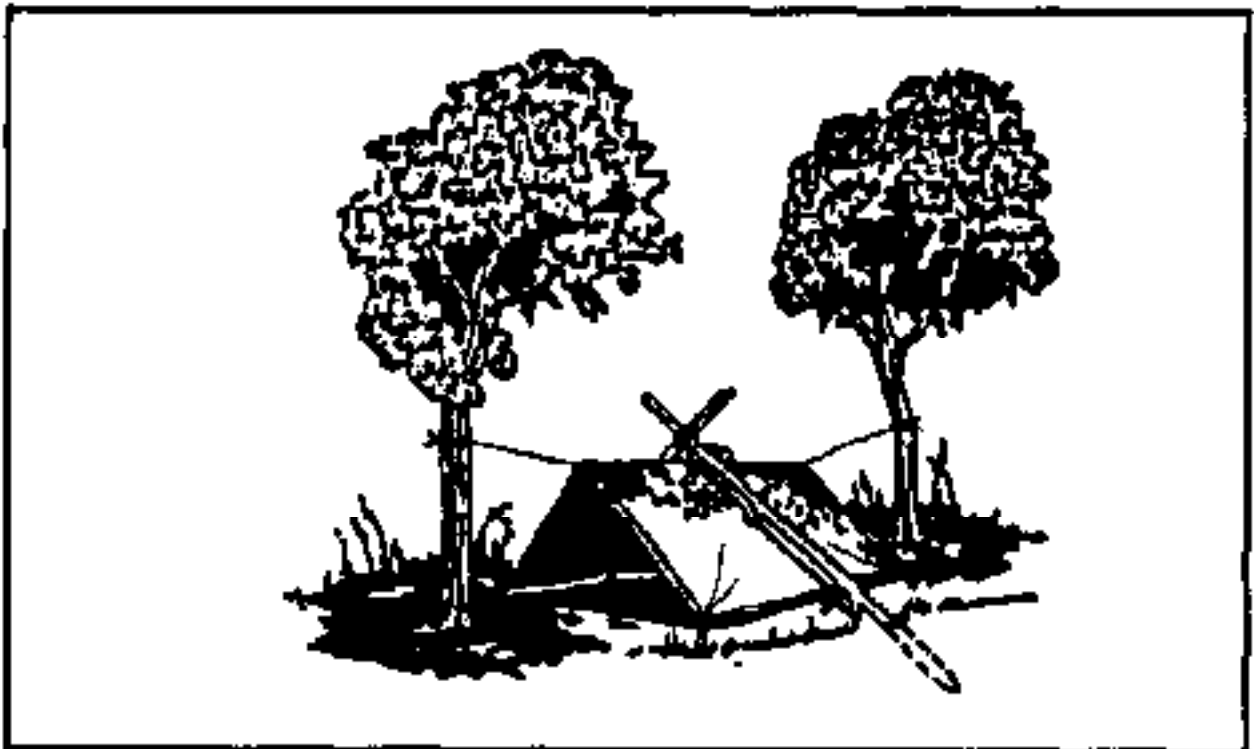

Figure 5-3. Poncho tent with A-frame.

Field-Expedient Lean-To: If you are in a wooded area and have enough natural materials, you can make a field-expedient lean-to (Figure 5-9) without the aid of tools or with only a knife. It takes longer to make this type of shelter than it does to make other types, but it will protect you from the elements.

You will need two trees (or upright poles) about 2 meters apart; one pole about 2 meters long and 2.5 centimeters in diameter; five to eight poles about 3 meters long and 2.5 centimeters in diameter for beams; cord or vines for securing the horizontal support to the trees; and other poles, saplings, or vines to crisscross the beams. To make this lean-to—

- 1) Tie the 2-meter pole to the two trees at waist to chest height. This is the horizontal support. If a standing tree is not available, construct a biped using Y-shaped sticks or two tripods.
- 2) Place one end of the beams (3-meter poles) on one side of the horizontal support. As with all lean-to type shelters, be sure to place the lean-to's backside into the wind.
- 3) Crisscross saplings or vines on the beams.
- 4) Cover the framework with brush, leaves, pine needles, or grass, starting at the bottom and working your way up like shingling.
- 5) Place straw, leaves, pine needles, or grass inside the shelter for bedding.

In cold weather, add to your lean-to's comfort by building a fire reflector wall (Figure 5-9). Drive four 1.5-meter-long stakes into the ground to support the wall. Stack green logs on top of one another between the support stakes. Form two rows of stacked logs to create an inner space within the wall that you can fill with dirt. This action not only strengthens the wall but makes it more heat reflective. Bind the top of the support stakes so that the green logs and dirt will stay in place.

With just a little more effort you can have a drying rack. Cut a few 2-centimeter-diameter poles (length depends on the distance between the lean-to's horizontal support and the top of the fire reflector wall). Lay one end of the poles on the lean-to support and the other end on top of the reflector wall. Place and tie into place smaller sticks across these poles. You now have a place to dry clothes, meat, or fish.

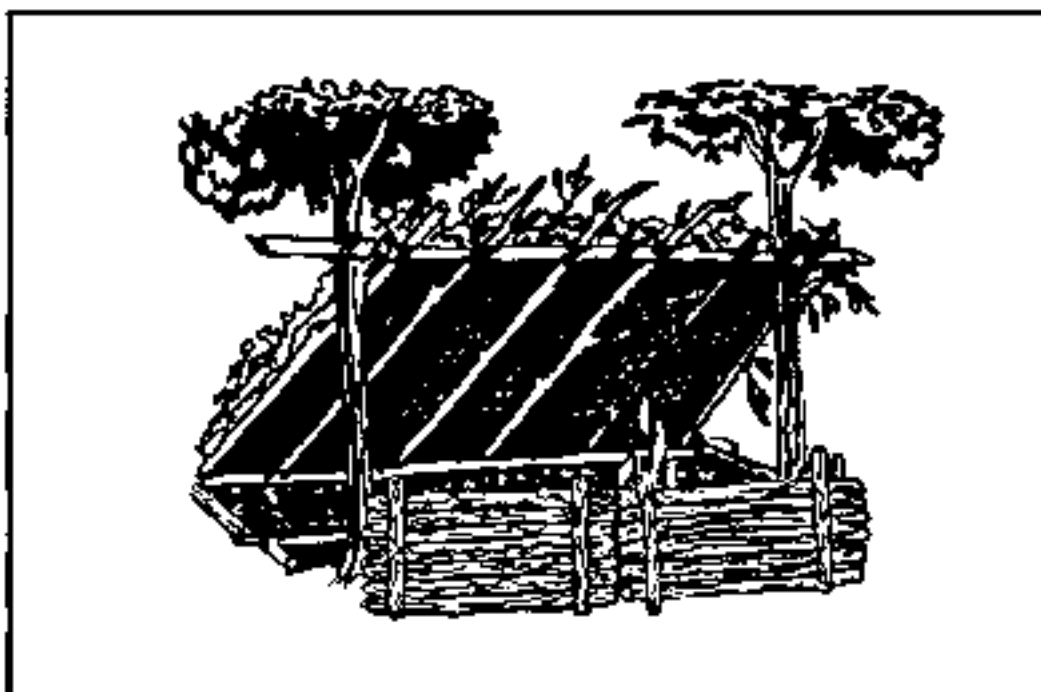

Figure 5-9. Field-expedient lean-to and fire reflector.

Swamp Bed: In a marsh or swamp, or any area with standing water or continually wet ground, the swamp bed (Figure 5-10) keeps you out of the water. When selecting such a site, consider the weather, wind, tides, and available materials. To make a swamp bed—

- 1) Look for four trees clustered in a rectangle, or cut four poles (bamboo is ideal) and drive them firmly into the ground so they form a rectangle. They should be far enough apart and strong enough to support your height and weight, to include equipment.
- 2) Cut two poles that span the width of the rectangle. They, too, must be strong enough to support your weight.
- 3) Secure these two poles to the trees (or poles). Be sure they are high enough above the ground or water to allow for tides and high water.
- 4) Cut additional poles that span the rectangle's length. Lay them across the two side poles, and secure them.
- 5) Cover the top of the bed frame with broad leaves or grass to form a soft sleeping surface.
- 6) Build a fire pad by laying clay, silt, or mud on one corner of the swamp bed and allow it to dry.

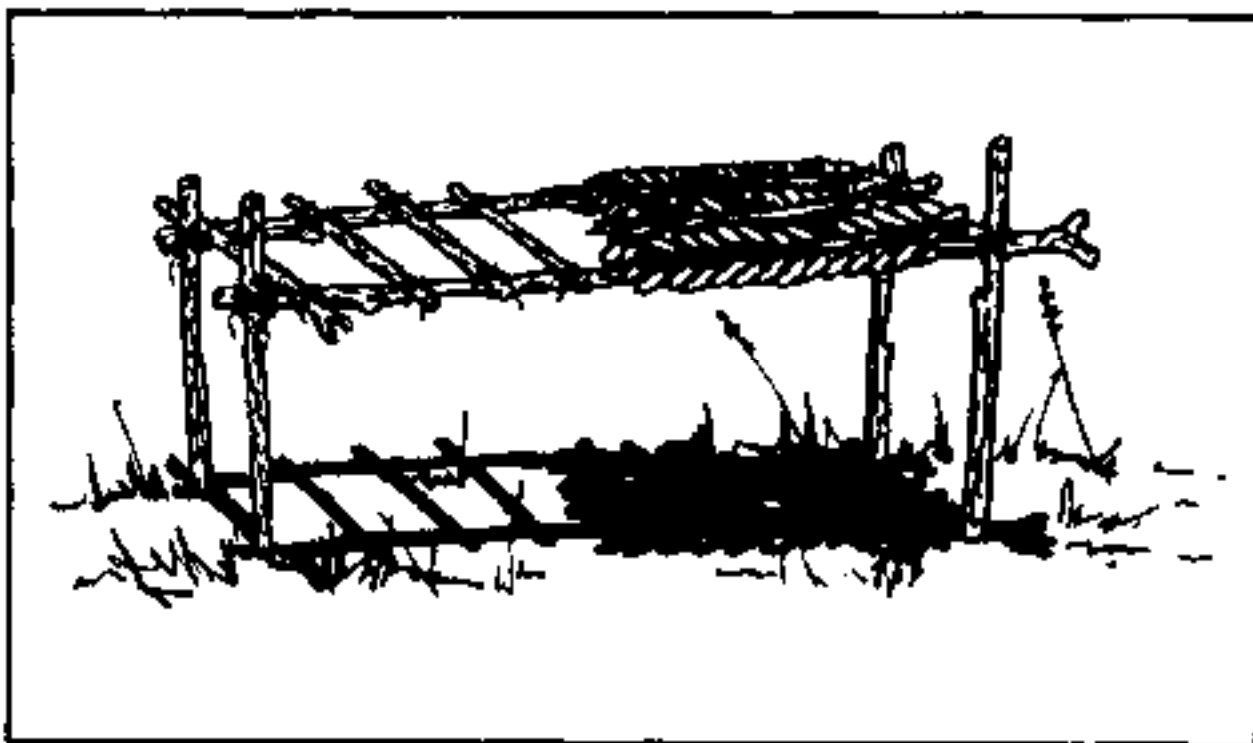

Figure 5-10, Swamp bed.

Another shelter designed to get you above and out of the water or wet ground uses the same rectangular configuration as the swamp bed. You very simply lay sticks and branches lengthwise on the inside of the trees (or poles) until there is enough material to raise the sleeping surface above the water level.

Natural Shelters: Do not overlook natural formations that provide shelter. Examples are caves, rocky crevices, clumps of bushes, small depressions, large rocks on leeward sides of hills, large trees with low-hanging limbs, and fallen trees with thick branches. However, when selecting a natural formation—

- Stay away from low ground such as ravines, narrow valleys, or creek beds. Low areas collect the heavy cold air at night and are therefore colder than the surrounding high ground. Thick, brushy, low ground also harbors more insects.
- Check for poisonous snakes, ticks, mites, scorpions, and stinging ants. Look for loose rocks, dead limbs, coconuts, or other natural growth that could fall on your shelter.

Debris Hut: For warmth and ease of construction, this shelter is one of the best. When shelter is essential to survival, build this shelter. To make a debris hut (Figure 5-11)—

- 1) Build it by making a tripod with two short stakes and a long ridgepole or by placing one end of a long ridgepole on top of a sturdy base.
- 2) Secure the ridgepole (pole running the length of the shelter) using the tripod method or by anchoring it to a tree at about waist height.
- 3) Prop large sticks along both sides of the ridgepole to create a wedge-shaped ribbing effect. Ensure the ribbing is wide enough to accommodate your body and steep enough to shed moisture.
- 4) Place finer sticks and brush crosswise on the ribbing. These form a latticework that will keep the insulating material (grass, pine needles, leaves) from falling through the ribbing into the sleeping area.
- 5) Add light, dry, if possible, soft debris over the ribbing until the insulating material is at least 1 meter thick—the thicker the better.
- 6) Place a 30-centimeter layer of insulating material inside the shelter.
- 7) At the entrance, pile insulating material that you can drag to you once inside the shelter to close the entrance or build a door.
- 8) As a final step in constructing this shelter, add shingling material or branches on top of the debris layer to prevent the insulating material from blowing away in a storm.

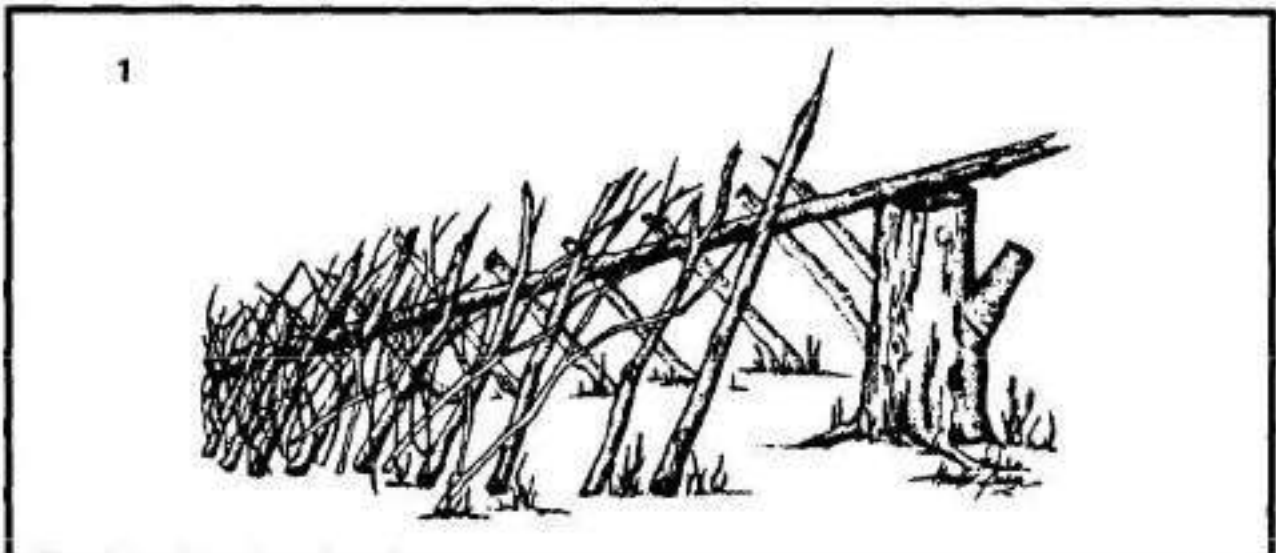

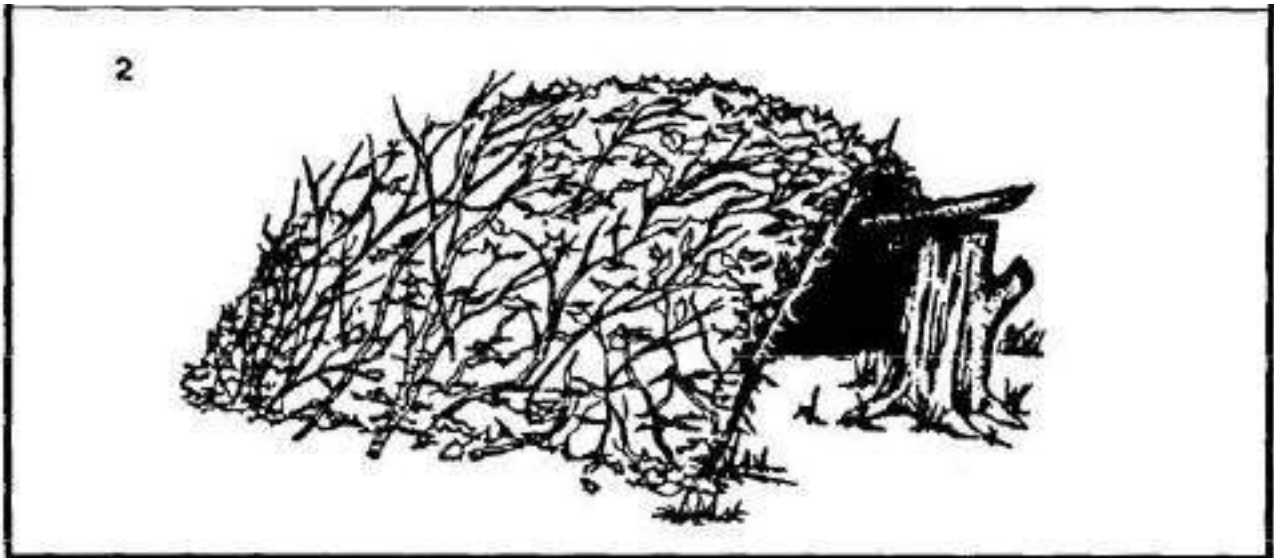

Figure 5-11. Debris hut.

Tree-Pit Snow Shelter: If you are in a cold, snow-covered area where evergreen trees grow and you have a digging tool, you can make a tree-pit shelter (Figure 5-12). To make this shelter (Figure 5-13)—

- 1) Find a tree with bushy branches that provides overhead cover.
- 2) Dig out the snow around the tree trunk until you reach the depth and diameter you desire, or until you reach the ground.
- 3) Pack the snow around the top and the inside of the hole to provide support.
- 4) Find and cut other evergreen boughs. Place them over the top of the pit to give you additional overhead cover. Place evergreen boughs in the bottom of the pit for insulation.

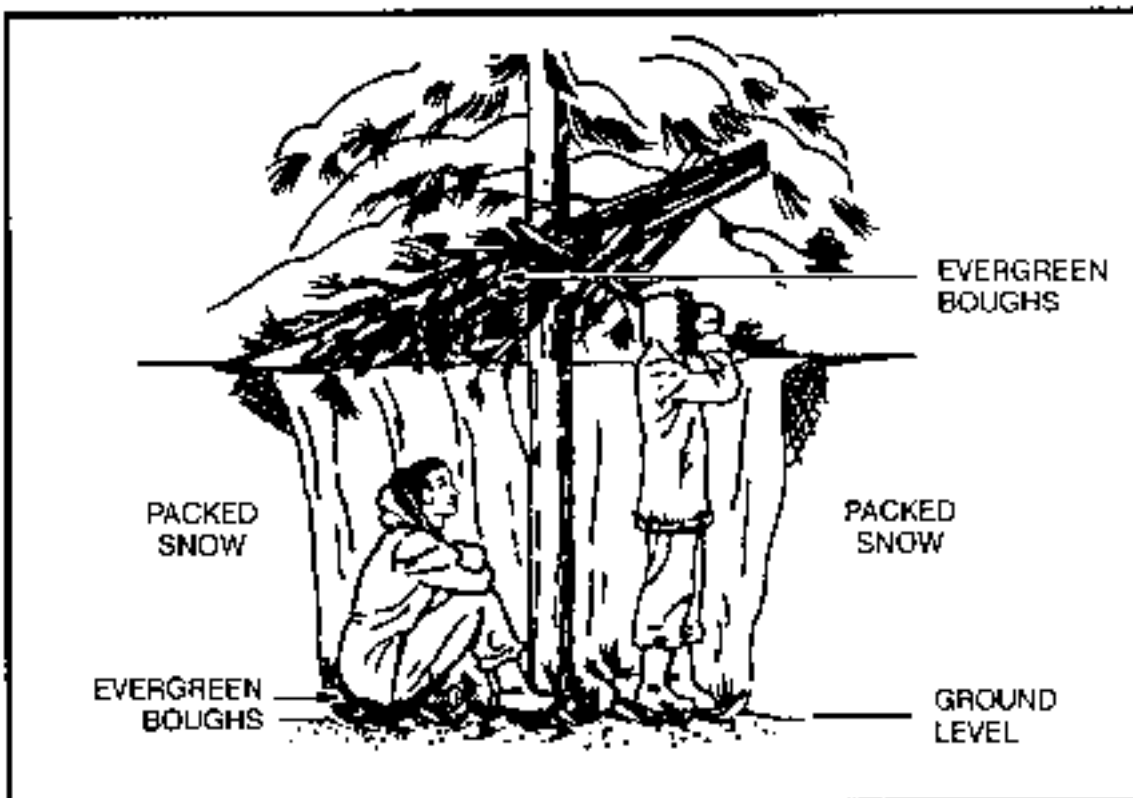

Figure 5-12. Tree-pit snow shelter.

Beach Shade Shelter: This shelter protects you from the sun, wind, rain, and heat. It is easy to make using natural materials. To make this shelter (Figure 5-13)—

- 1) Find and collect driftwood or other natural material to use as support beams and as a digging tool.
- 2) Select a site that is above the high water mark.
- 3) Scrape or dig out a trench running north to south so that it receives the least amount of sunlight. Make the trench long and wide enough for you to lie down comfortably.
- 4) Mound soil on three sides of the trench. The higher the mound, the more space inside the shelter.
- 5) Lay support beams (driftwood or other natural material) that span the trench on top of the mound to form the framework for a roof.
- 6) Enlarge the shelter's entrance by digging out more sand in front of it.
- 7) Use natural materials such as grass or leaves to form a bed inside the shelter.

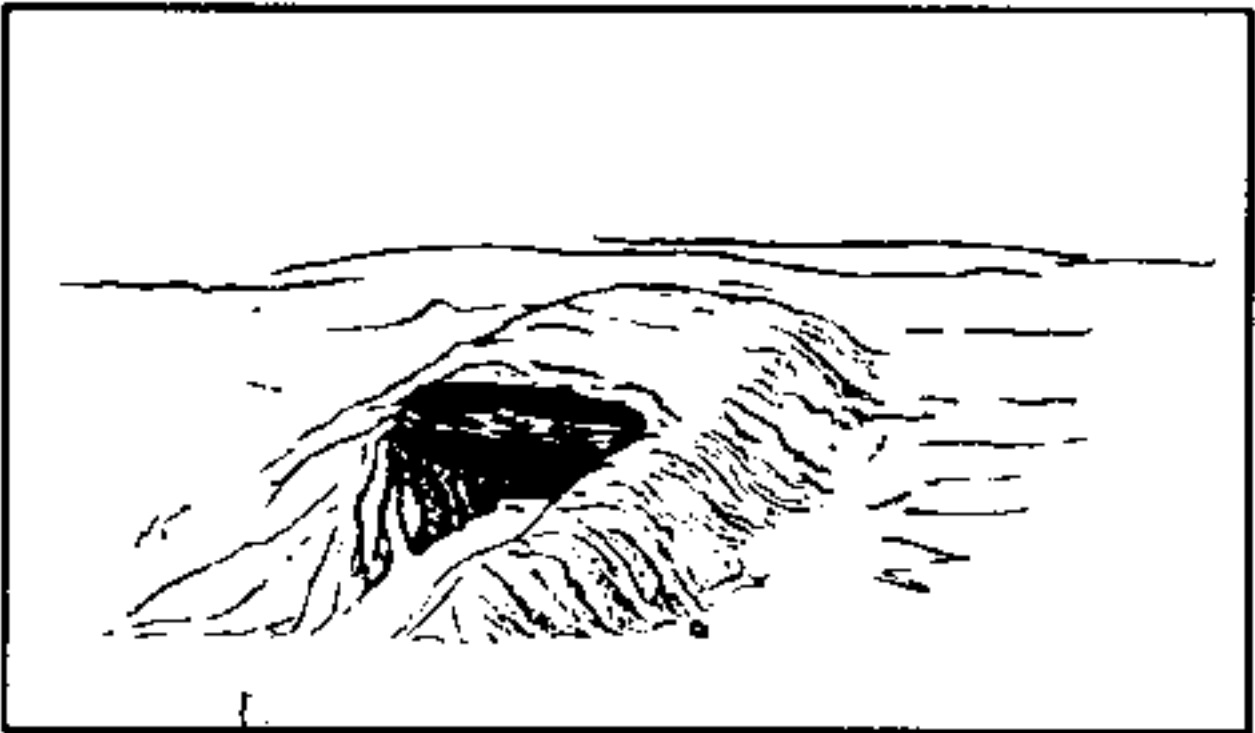

Figure 5-13. Beach shade shelter.

Desert Shelters: In an arid environment, consider the time, effort, and material needed to make a shelter. If you have material such as a poncho, canvas, or a parachute, use it along with such terrain features as rock outcropping, mounds of sand, or a depression between dunes or rocks to make your shelter.

Using rock outcroppings—

- 1) Anchor one end of your poncho (canvas, parachute, or other material) on the edge of the outcrop using rocks or other weights.
- 2) Extend and anchor the other end of the poncho so it provides the best possible shade.

In a sandy area—

- 1) Build a mound of sand or use the side of a sand dune for one side of the shelter.
- 2) Anchor one end of the material on top of the mound using sand or other weights.

3) Extend and anchor the other end of the material so it provides the best possible shade.

Note: If you have enough material, fold it in half and form a 30-centimeter to 45-centimeter airspace between the two halves. This airspace will reduce the temperature under the shelter.

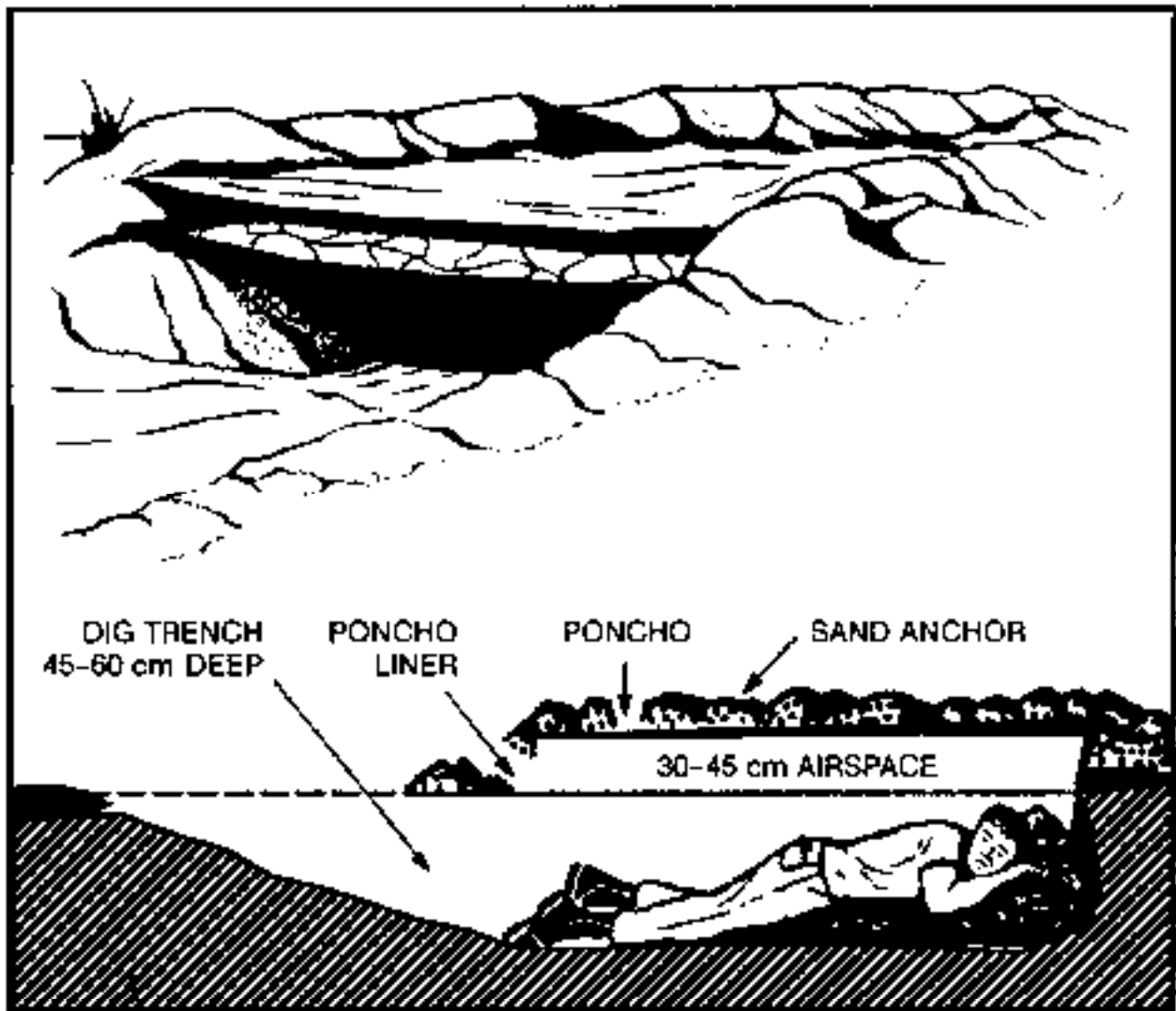

Figure 5-14. Belowground desert shelter.

A belowground shelter (Figure 5-14) can reduce the midday heat as much as 16 to 22 degrees C (30 to 40 degrees F). Building it, however, requires more time and effort than for other shelters. Since your physical effort will make you sweat more and increase dehydration, construct it before the heat of the day. To make this shelter—

- 1) Find a low spot or depression between dunes or rocks. If necessary, dig a trench 45 to 60 centimeters deep and long and wide enough for you to lie in comfortably.
- 2) Pile the sand you take from the trench to form a mound around three sides.
- 3) On the open end of the trench, dig out more sand so you can get in and out of your shelter easily.
- 4) Cover the trench with your material.
- 5) Secure the material in place using sand, rocks, or other weights.

If you have extra material, you can further decrease the mid day temperature in the trench by securing the material 30 to 45 centimeters above the other cover. This layering of the material will reduce the inside temperature 11 to 22 degrees C (20 to 40 degrees F).

Another type of belowground shade shelter is of similar construction, except all sides are open to air currents and circulation. For maximum protection, you need a minimum of two layers of parachute material (Figure 5-15). White is the best color to reflect heat; the innermost layer should be of darker material.

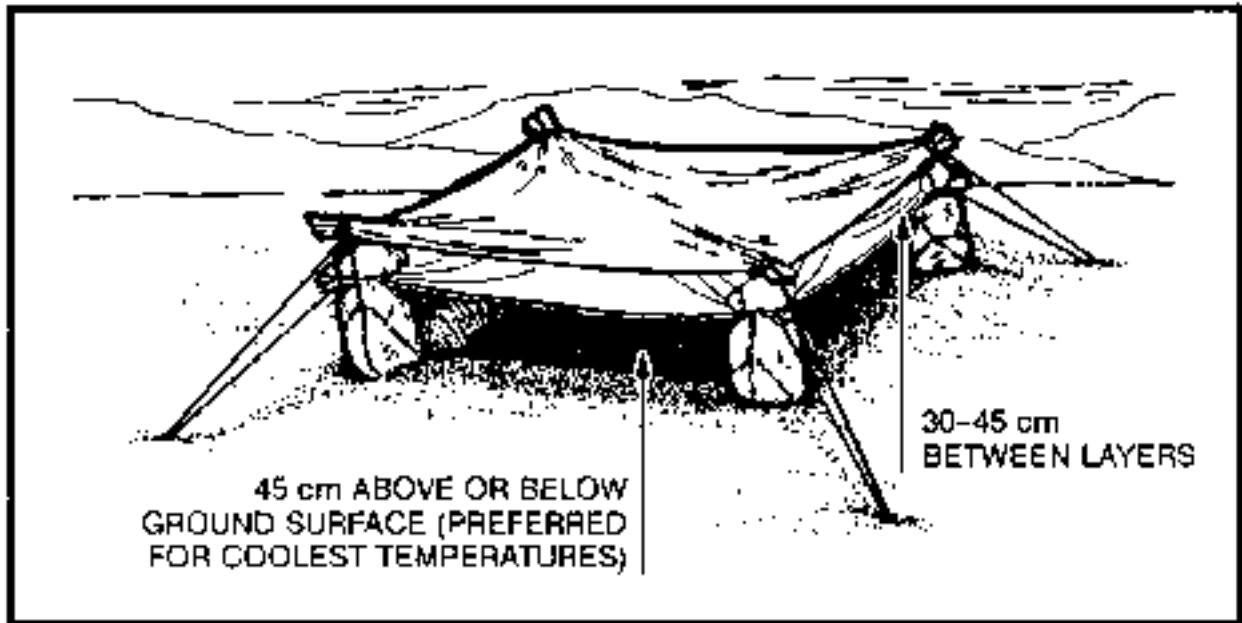

Figure 5-15. Open desert shelter.

CHAPTER XXIV: MEDICAL MANUAL

Note: This chapter is largely taken from the The Aidman's Medical Guide by the HQ Department of the Army.

This chapter is intended primarily for the medical aidman in the field. It tells you what to do with the supplies and equipment that you can carry and can use without hot or running water or electrical power. It also tells you how to protect yourself and your patients. Injuries, wounds and medical diseases will be covered.

In the field, you can give emergency medical treatment but you do so with limited resources. Your physical resources are limited by two things: the tactical situation and how much you can carry. You are trained to improvise in some situations, and to request assistance in others.

In addition to lifesaving and first aid measures, disposition of patients is your job. When a soldier is wounded, or when you are faced with a medical problem, ask yourself, "Should I evacuate this man or treat him here?" Often, the tactical situation and the nature of man's illness or injuries require you to treat him. This chapter tells you how to treat him.

What the first-aid kit will contain has been mentioned within the "Equipment" section of chapter 21 "Guerrilla organization" but will be repeated here:

- Small first-aid kit with basic first-aid instructions
- Bandage pack (on the body)
- Gauze
- Quinine
- Aspirin
- Anti-biotics
- Vitamin Drops
- Tannalbin
- Amphetamines
- throat lozenge
- Water purification tablets
- Salt tablets
- Antimalarials
- Gelusil
- Tetracaine

Other drugs with similar effect (other anesthetics than tetracaine or other anti-acids than gelusil) may be used if the medical research is done beforehand.

When witnessing a medical problem, make a judgment or tentative diagnosis. For example, if the wound is serious, will the patient die soon without definitive medical treatment? If the wound is not serious, can he continue his mission with some treatment? What is the tactical situation? How much time do you have? How much help can you get?

Take some positive action:

1. Get yourself and the patient in the safest position consistent with his injuries and the tactical situation.
2. Clear the airway and give CPR if necessary. Control hemorrhage as quickly as possible. Treat for shock if necessary.
3. Ask for assistance. Move the patient to a safer place and request evacuation if indicated.
4. Reassure the patient. Positive action will reassure him more than anything you can say to him. It may also save him. Take note of the placebo effect.

3-1. Danger of Acute Hemorrhage

Acute hemorrhage is a rapid loss of blood from the blood vessels. In the event of an acute severe hemorrhage (loss of at least two pints of blood), an emergency is present. If the bleeding is not stopped, the patient will die.

3-2. Blood

Blood is a mixture of water, salts, protein, red and white blood cells, platelets, food, waste, hormones, enzymes, antibodies, and other substances. The three most important elements of blood lost in acute hemorrhage are water, salt, and red blood cells. Water is the fluid that fills the blood vessels so the heart can function properly. Water also keeps other elements in suspension so they can be carried throughout the body. Salt maintains the proper chemical balance of body fluids; it must be contained in fluids used to replace lost blood. Red cells carry oxygen to the whole body including brain, heart, and other vital organs.

3-3. Vascular System

Blood is contained in a system of tubes or vessels called arteries, capillaries, and veins which together form the vascular system. The heart pumps the blood through the system. If a blood vessel is opened, bleeding results.

a. Arterial Bleeding. Blood leaves the heart through the arteries under pressure. If an artery is opened, blood will come out forcefully in spurts. With each beat of the heart there will be a corresponding spurt of blood. The larger the artery, the more rapid the blood loss.

b. Venous Bleeding. Blood flowing through veins is under less pressure than in arteries. However, a break in a vein will allow blood to flow out of it. The rate of blood loss depends upon the size of the opened vein.

3-4. Control of Hemorrhage

Control of hemorrhage is primarily mechanical. The mechanics of control consist mainly of closing off the open blood vessels. This

may be done in several ways. The method most feasible in one instance may not be best in another instance.

a. Direct Pressure. This is the best and usually the most practical, method for the company aidman to use. In this method, blood vessels are compressed against bone and flesh, usually by a pressure dressing applied directly over the wound. Almost any bleeding can be controlled this way. A special type of direct pressure is to apply a clamp directly to the bleeding vessel to close it off. Caution must be exercised that only the bleeding vessel is clamped.

b. Pressure Points. In this method, the artery is compressed at a point proximal to the wound, stopping the flow of blood. This method is not recommended if pressure must be maintained for a long period of time, but may be useful temporarily until a pressure dressing can be applied.

c. Tourniquet. A tourniquet will totally stop the flow of blood in the arm or leg beyond the tourniquet. Consequently, although it will stop the bleeding by compressing all the vessels, it is potentially dangerous because it deprives the uninjured tissues of blood. As a general rule, if a tourniquet is necessary, place it as close as possible to the wound between the heart and the wound to stop the bleeding. Some arteries, however, pass between two bones (as in the forearm) and cannot be compressed by a tourniquet. This would necessitate placing the tourniquet on the upper arm to stop the bleeding. Patients who have tourniquets applied should be clearly identified with a "T" on their forehead. Once applied, a tourniquet should never be loosened or removed, except under the supervision of a medical officer.

d. Elevation. If bleeding from a wound is only venous or capillary, elevation of the wound above the heart may slow the flow of blood. However, elevation is of no value in control of arterial bleeding, and may aggravate fractures.

e. Combination of Methods. A combination of measures is usually most effective. One combination is to use pressure points until a pressure dressing can be applied.

3-5. Clotting

Blood clots are formed by a chemical reaction that occurs when blood platelets escape from blood vessels. Slowing the flow of blood from a wound improves conditions for formation of a clot. A gauze dressing placed over a wound slows the escape of blood and gives it something on which to form a clot. This is another reason why a combination of gauze dressing and pressure is the best method of controlling external bleeding in combat wounds.

3-6. Internal Bleeding

Internal bleeding often results from penetrating or perforating wounds of the body, especially the abdomen and chest. Shock in patients with such wounds is good evidence of internal bleeding. In the field you can do little to control internal bleeding. The patient must be kept still to allow maximum blood flow to vital organs and prevent further internal damage. He should be evacuated as soon as possible. Do not give anything by mouth.

3-7. Anoxia

Anoxia, or lack of oxygen, is the most critical medical emergency. Vital organs, particularly the brain, cannot withstand anoxia—that is, cannot be deprived of oxygen—for more than 5 minutes without being damaged permanently. Oxygen deprivation can occur in one or more of the following conditions.

a. The atmosphere can be deficient in oxygen or contain poisons that prevent the body from using oxygen it takes in. Examples of these poisons are toxic chemical agents (toxic gases), carbon monoxide, smoke, and hot gases.

b. The respiratory system may fail or be prevented from taking in enough oxygen. Respiratory failure can be caused by—

(1) Blockage of the air passages by foreign matter such as water (drowning), mud, blood, vomitus, or wound tissue or by swelling caused by burns or other wounds.

(2) Injury to the part of the brain that controls respiration.

(3) Collapse of the lungs because of chest wounds or filling of the chest cavity with blood.

(4) Depression of the respiratory center of the brain by morphine or other drugs.

(5) Severe, extensive lung disease such as pneumonia.

c. The cardiovascular system may fail to circulate red blood cells. This can be caused by failure of the heart or large blood vessels due to trauma or disease and by insufficient volume in the vascular system due to loss of blood, water, or salt.

3-8. Artificial Respiration in the Acutely Injured Patient

If a patient stops breathing you must assist him immediately. The situation will dictate the method to be used. Regardless of the situation, however, immediate steps must be taken to clear the airway. If spontaneous breathing does not result, positive pressure artificial respiration must be begun (para 3-9). This is the only acceptable method of artificial respiration. It can be given mouth to mouth, mouth to nose, mouth to oral airway tubing, mouth to emergency surgical airway, or protective mask to protective mask by a connecting tube. Mechanical devices for supplying posi-

tive pressure are available at aid stations. Methods using negative pressure, such as the modified Sylvester method, are of no value.

a. Wound of the Face or Neck.

- (1) Clear the airway of blood clots and wound tissue.
- (2) Place the patient in the best position for drainage.
- (3) If the patient is not breathing, and if mouth-to-mouth or mouth-to-nose respiration is not possible, perform an emergency surgical airway and begin positive pressure respiration through this airway.

(4) Get assistance in controlling hemorrhage. Such a casualty may have two life-threatening problems: bleeding and breathing. Alone, you may be unable to save his life.

b. Wounding With Drowning. A soldier wounded while crossing a stream, a swamp, or a paddy often will sink under the water or mud. If you do not have time to recover him and move him to dry ground, you should do the following things—

- (1) Raise his head above the water.
- (2) Clear the airway of mud or debris with your fingers.
- (3) Using mouth-to-mouth respiration, give him one or two quick puffs of air.
- (4) Quickly remove some of his gear if it is too heavy to support.
- (5) Give him a few more quick puffs of air mouth-to-mouth.
- (6) Call for assistance.
- (7) Give him a few more puffs of air mouth-to-mouth while moving him from the line of fire and toward dry land.
- (8) If he is bleeding, request assistance in controlling the bleeding while continuing mouth-to-mouth respiration until his breathing is restored.

c. Blockage of Air Passage by Vomitus. This is a frequent cause of death. Vomiting can be expected in a patient semiconscious from heat exhaustion, or in a painfully wounded patient who has been given morphine, or in a man who has received a blow on the head or abdomen. Vomiting is common in a man who is unconscious, semiconscious, or stuporous while under the influence of alcohol or drugs. Aspiration (breathing in) of vomitus will block the airway. A person's airway can be blocked when he chokes on large pieces of food. Blockage of the airway requires the following immediate actions.

- (1) Clear the airway of the blocking material.
 - (2) Give the man a few quick puffs of air mouth-to-mouth.
- If the blocking material cannot be removed and continues to block the airway, an artificial opening must be made in the trachea (para 3-10).

(3) After the opening has been made, the patient should

begin to breathe. If he does not breathe, you should perform mouth-to-artificial airway respiration. Continue artificial respiration until he is breathing. If there is no carotid pulse, external cardiac massage plus artificial respiration should be performed as described in paragraph 3-11.

d. Failure of Respiration Due to Injury to Nervous System or Overdose of Drugs. At once begin mouth-to-mouth artificial respiration and continue it until the patient can breathe or mechanical respiration is begun.

3-9. Mouth-to-Mouth and Mouth-to-Nose Artificial Respiration

The only acceptable methods of artificial respiration, short of mechanical devices or surgical airway, are mouth-to-mouth and mouth-to-nose. Both are methods of inflating the patient's lungs with the aidman's breath. The mouth-to-mouth method is preferred, but when the patient's jaw is tightly closed by spasm or when he has a mouth wound, the mouth-to-nose method may be used. Both methods are illustrated in figure 3-1. Steps in the expired air technique are as follows.

- a. Position the patient on his back.
- b. Clear the upper airway by running your fingers behind his lower teeth and over the back of his tongue. Remove any dentures or foreign material.
- c. Turn his head face up. Tilt the head back so that the neck is stretched and the chin is up (fig 3-1①).
- d. Adjust the lower jaw so that it juts out (fig 3-1② and ③). This positioning moves the base of the tongue away from the back of the throat, thus clearing or enlarging the air passage to the lungs.
- e. Seal the airway opening (either the nose or the mouth) which is not being used. The seal must be secure to keep air from leaking during inflation. Pinch the nostril shut with your free fingers or seal the mouth by placing two fingers lengthwise over the patient's lips (fig 3-1④ and ⑤).
- f. Take a deep breath. Open your mouth wide and make an airtight seal around the patient's mouth or nose.
- g. With your eyes focused on the patient's chest, blow forcefully into his airway. Rising of the patient's chest indicates air is reaching his lungs. If the chest does not rise, you must take these corrective actions.

(1) Hold up his jaw more forcefully and hyperextend his neck.

(2) Blow harder into his mouth or nose, making sure air is not leaking from the other airway opening.

(3) Recheck his mouth for foreign matter. If there is a defi-

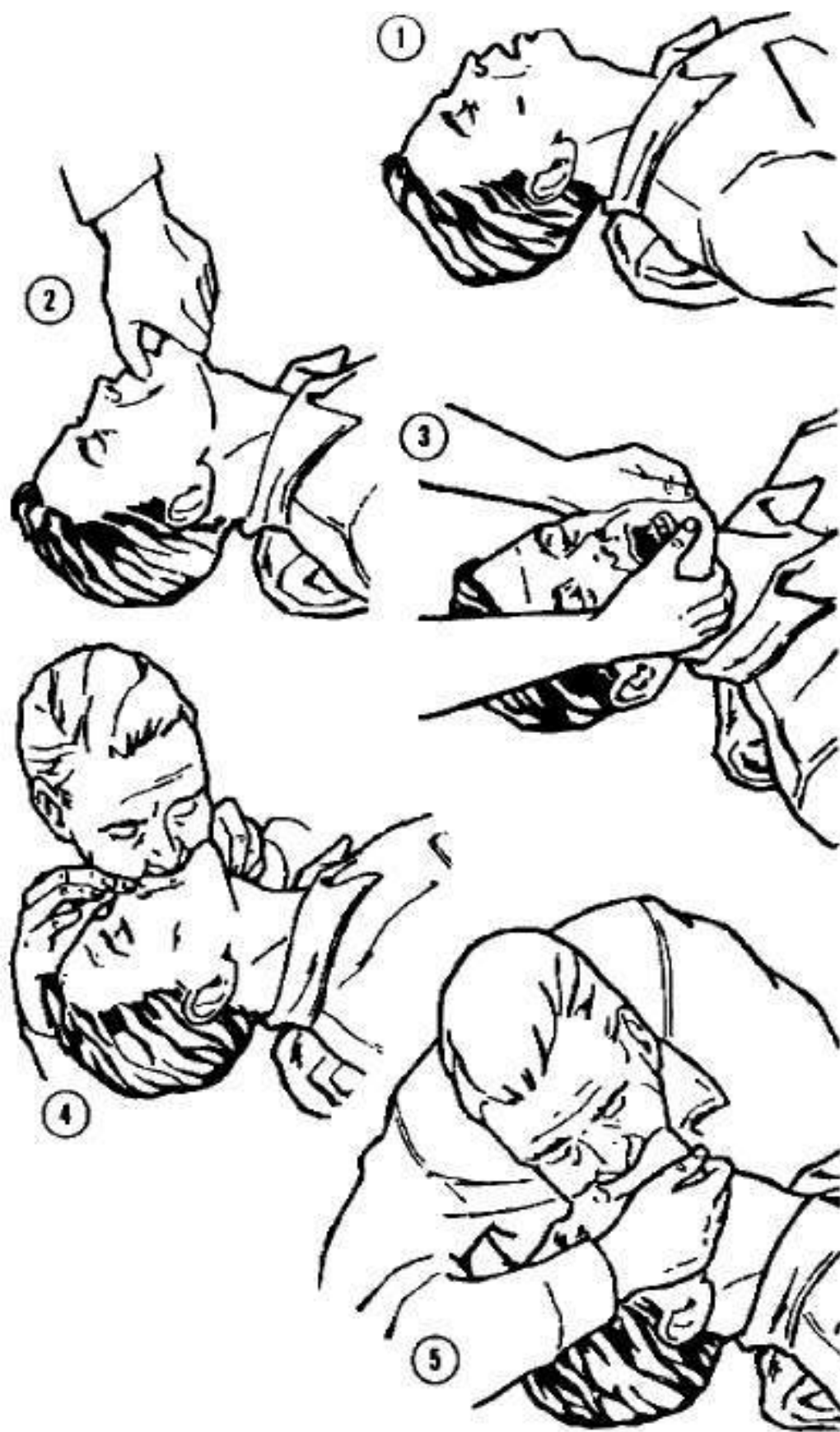

Figure 3-1. Steps in mouth-to-mouth and mouth-to-nose artificial respiration.

nite obstruction of the airway, an emergency surgical opening must be made.

(4) Remove your mouth, listen for the return of air from the patient's lungs. If the exhalation is noisy, elevate his jaw further.

(5) This procedure should be repeated 12 times a minute.

h. If these steps fail to permit inflation of the lungs, an emergency surgical airway must be made.

3-10. Emergency Surgical Airway

Again, most airway obstructions are relieved by nonsurgical measures. Clearing the upper air passages with the fingers, positioning the head, neck, and body, adjusting the lower jaw, or a sharp blow on the patient's back may be all that is needed to dislodge an obstruction. Persistent obstruction of the airway, however, requires an immediate surgical airway for relief. Diagnosis is established when the patient's lungs cannot be inflated by mouth-to-mouth (or mouth-to-nose) respiration.

a. A patient with persistent airway obstruction will be hard to restrain, if conscious, so you will need someone to help you hold him.

b. Quickly get the sharpest cutting instrument you can find.

c. Have your assistant immobilize the patient while you locate the area over the cricothyroid membrane to make an incision.

d. The cricothyroid membrane is the best place to make an emergency surgical airway. It is just beneath the skin in the middle of the front of the neck. It is between the thyroid cartilage ("Adam's apple") just above it and the less prominent (in males) cricoid cartilage below it. See figure 3-2 for location of incision site.

e. While immobilizing the skin and trachea with one hand, make an incision horizontally over the cricothyroid membrane through the skin. Then make a second incision into the larynx through the membrane until a finger-sized opening is obtained.

f. At this point, the patient should make a gasping inhalation through the opening which you have made. Enlarge the opening enough with your fingers to allow complete filling of the lungs. Let the patient breathe through the opening until he is partly stabilized while you assist by stretching the opening.

g. Insert a cannula or a tubelike item into the opening. Secure the cannula in the trachea, as in figure 3-3, to prevent it from being aspirated or dislodged. Any tubelike item may be used, including the barrel of a ball-point pen.

h. Place the patient in a position most comfortable to him.

i. If the patient does not breathe on his own, apply positive pressure respiration to the airway.

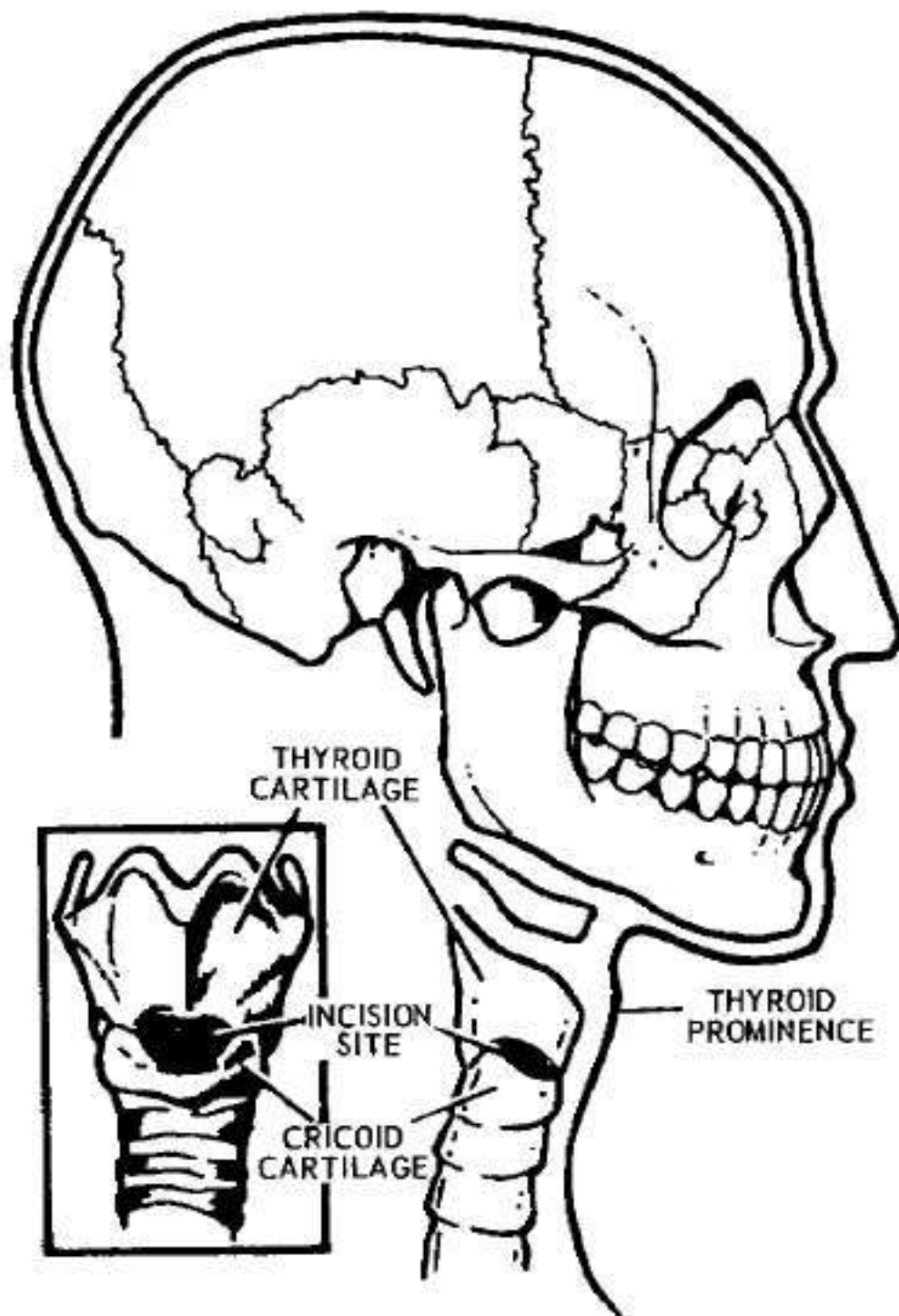

Figure 3-2. Site of incision for cricothyroidotomy.

3-11. Cardiac Arrest (Heart Stoppage)

Cardiac arrest, or heart stoppage, may be caused by insufficient oxygen supply to the heart or the brain, blockage of blood vessels of the heart, heart disease, foreign particles in the bloodstream (embolism), or overdosage of some drugs. Respiratory arrest is the most common cause of cardiac arrest. The heart will stop within minutes after breathing ceases.



Figure 3-3. Cannula inserted and secured in trachea.

a. Signs and Symptoms.

- (1) Absence of a carotid pulse.
- (2) Cessation of breathing.
- (3) Dilated pupils of the eyes.
- (4) Unconsciousness.
- (5) Limp body and flaccid skin.
- (6) Cyanosis.

b. Actions to Take Immediately.

- (1) Roll the victim onto his back.
- (2) Check his airway and remove any obstruction.
- (3) Hyperextend the neck and lift the lower jaw for mouth-to-mouth artificial respiration.
- (4) Give him five quick puffs of air by mouth-to-mouth.
- (5) Place the heel of your hand on the lower half of the sternum and press down until the sternum is depressed about 2 inches, as in figure 3-4①. Repeat this compression about 15 times, about 1 per second.
- (6) Return to mouth-to-mouth artificial respiration and give the victim two respirations.
- (7) Repeat this 15-2 cycle until help arrives or you are certain the patient is dead.
- (8) If help is available, one person should give the cardiac compressions and the other should give mouth-to-mouth artificial

respiration as in figure 3-4②. The ratio with two operators should be about five compressions to one artificial respiration. The compressions should not be interrupted, even for the respirations. When respiration is being applied, the compressions must be stopped momentarily.

(9) The cardiac compressions should equal about 60 per minute, the respirations about 12 per minute.



ONE OPERATOR



TWO OPERATORS

Figure 3-4. Cardiac compression applied by one operator and by two operators.

3-12. Shock

Shock is a complex subject, but basically it means that the body tissues are not getting enough blood. The most common cause is hemorrhage where blood escapes from the vascular system and consequently does not get to the tissues.

a. Diagnosis. There are four broad areas of symptoms in shock. The first involves feeling the pulse, which is usually abnormally rapid. There is also a drop in blood pressure which is detectable by a weakened pulse. The second area is increased respiratory rate—the body's response to the lack of oxygen in the tissues. The third area is the skin which is usually cool and clammy and pale due to decreased blood flow. The fourth is changed mental state. In early shock, the patient frequently is agitated and restless. As the shock worsens and the brain is deprived of blood, drowsiness and unconsciousness result. In addition to these considerations, certain wounds are commonly associated with shock. When these wounds are present, treatment for shock should be begun even before the clinical signs and symptoms appear. These wounds include:

(1) Any wound which penetrates the belly, chest, neck, or pelvis. Internal bleeding is a likely possibility.

(2) Any wound of the arms or legs which has damaged a portion of tissue at least as big as a fist. Many bullet wounds of the thigh are in this category.

(3) Any wound which includes a fracture of a large bone. Blood loss of at least 1 quart frequently accompanies a fractured femur, for example.

(4) Any wound which results in blood loss of 1 quart or more. The blood may be visible on the ground, for example. If the blood has completely soaked a standard field dressing, this indicates loss of nearly a quart into the dressing. Treatment for shock is indicated. (A useful experiment you might try is to pour water into a dry field dressing to see how much water it takes to saturate it.)

b. Treatment. First, stop the bleeding and insure that the patient is breathing adequately. Position the patient on his back with his head down to enhance the flow of blood to the brain. Immediately begin intravenous (I.V.) fluid therapy, preferably through at least two veins. Administer fluids cautiously in the presence of possible intracranial injury. Make sure the patient is comfortable and reassure him. This can help prevent worsening of the shock.

c. Available Intravenous Solutions. Figure 3-5 shows several intravenous solutions and an intravenous injection set. One way

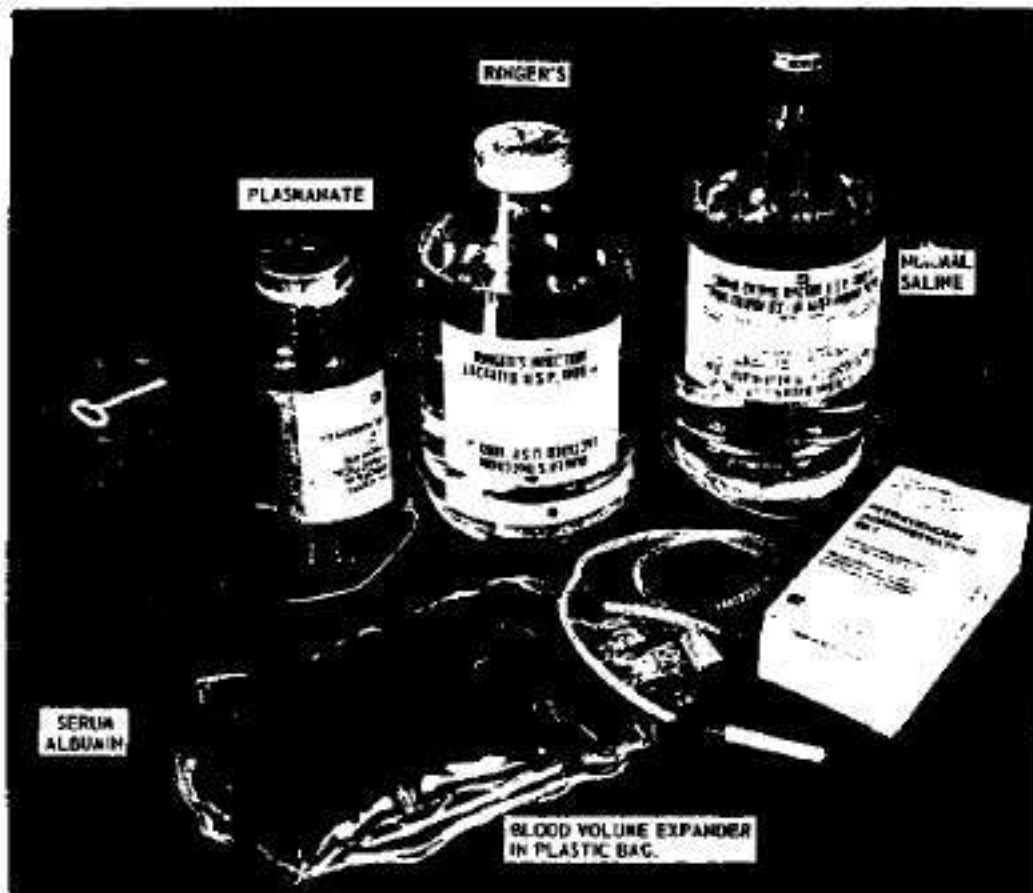

Figure 3-5. Blood volume expanders and infusion set.

of carrying bottles—in canteen covers—appears in figure 3-6. Solutions available to you include the following:

(1) Ringer's lactate solution (lactated Ringer's injection) is the most commonly used volume expander for treating hemorrhagic shock when blood is not available. It is a sterile solution of calcium chloride, potassium chloride, sodium chloride, and sodium lactate in water for injection. Its composition is closer to that of the extracellular fluid than is that of any other solution employed as a fluid and electrolyte replenisher. It expands the extracellular fluid volume which includes the blood volume. Ringer's solution is normally supplied in 1,000 cc. bottles but it can be procured in 500 cc. plastic containers.

(2) Normal saline (sodium chloride solution) is the second most commonly used intravenous fluid replacement. It can be used interchangeably with Ringer's lactate solution and is also an expander of extracellular fluid volume.

(3) Plasmanate is derived from human plasma which has been heat-treated to kill the hepatitis virus, and diluted to 5 percent strength in a solution similar to saline. Plasmanate is rich in albumin and tends to remain in the blood vessels; thus, it is a

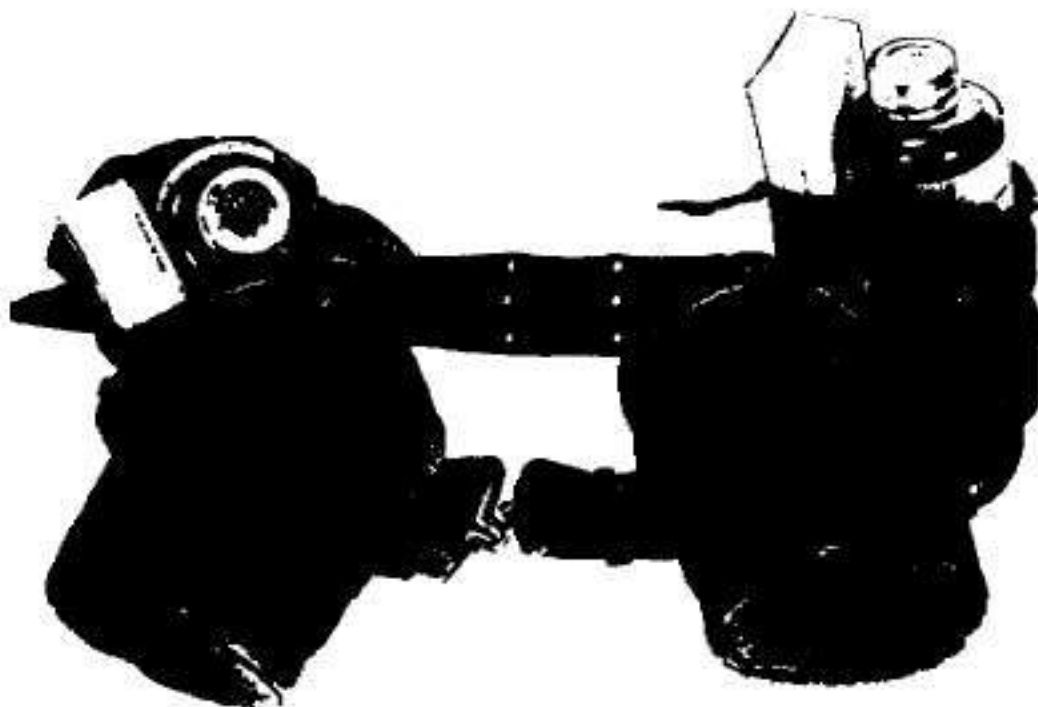

Figure 3-6. Blood volume expander carried in canteen cover.

plasma expander. It is an excellent replacement fluid for shock. It is supplied in 500 cc. bottles.

(4) Serum albumin is a concentrated protein in a small volume of water. It is useful in treatment of shock primarily if given with saline or Ringer's lactate. Used alone, it attracts water from within the cells and tissue spaces into the bloodstream. This may be dangerous, especially if the shock is due to dehydration, as in severe diarrhea. It is usually supplied in 100 cc. vials.

d. Use of Fluids in Hemorrhagic Shock. Blood is the best volume expander. It should be used in preference to anything else to treat shock due to hemorrhage. To avoid a reaction, only the proper type of blood should be given. You may not have either the blood or the facilities for typing it. As rapidly as possible, get the patient to where these facilities and blood are available. Meantime, start rapid replacement (two intravenous injections) with saline or Ringer's lactate. If plasmanate is available, use it instead. In an emergency, when evacuation will be delayed several hours, oral saline solution can be of great benefit if the patient does not have an abdominal wound and if he is fully conscious. Mix the salt and soda packet from your aid bag in the coolest potable water you can get. Encourage but do not force the patient to drink it. If he vomits, go slower, and keep trying to have him drink it. Usually he can keep down most of it. If you are isolated overnight with a patient who has a 50 percent burn, 7 to 10 liters (or quarts) of oral saline may keep him alive.

WOUNDS: CLASSIFICATION, STABILIZATION, AND EVACUATION

4-1. Classification of Wounds

For treatment and recording purposes, wounds are classified by cause, type, or appearance.

a. Classification by Cause.

(1) *Bullet wounds.* These wounds differ according to the type of weapon that fires the bullet. Damage to underlying tissue is affected by the size of the bullet and the velocity of the bullet as it strikes the patient.

(2) *Fragmentation wounds.* These are wounds made by fragments of exploding grenades, mortars, mines, booby traps, rockets, bombs, and artillery rounds. The explosion throws bits of metals in all directions, often causing multiple wounds of varying sizes.

(3) *Wounds due to falls.* A fall while a soldier is taking cover, especially with a pack on his back, can cause twisting, tearing, or wrenching wounds. A fall from a moving vehicle may result in broken bones and bruises.

(4) *Burns.* Burns can be caused by many sources. The ones encountered most frequently are napalm weapons, flame throwers, gasoline, white phosphorus grenades, or marking rounds. Burns are discussed in detail in paragraph 5-10.

b. Classification by Appearance.

(1) Bullets and shell fragments make penetrating wounds, perforating wounds, or both. A penetrating wound is one in which the bullet or fragment enters but does not leave the body. Knife or bayonet wounds also are included in this category. A perforating wound is one in which the bullet or fragment goes all the way through the body and makes at least two wounds, one of entrance and one or more of exit. The exit wound is often larger than the wound of entrance and may be located in an area of the body distant from the entrance wound. Therefore, every patient with a bullet wound must be examined thoroughly to see if he has more than one wound.

(2) A laceration is a cut or a tear. Unless they involve major blood vessels or impair breathing, lacerations are not a special

lifesaving problem for the aidman. Since they can be large and appear nasty, they may make the patient apprehensive. Usually there is more fright than pain with a laceration. The main problem with a lacerated wound incurred in combat is that it becomes infected easily. To prevent infection and to promote growth of new tissue, the wound must be debrided. The process of debriding, or debridement, is the surgical removal of all dirt, contamination, and dead tissue. This procedure must be done at a treatment facility under sterile conditions. After debridement such wounds are often left unsutured for a few days. The procedure, called "delayed primary closure," or "DPC," prevents infection and permits better healing. All combat wounds, regardless of size, are considered contaminated and should receive delayed primary closure.

(3) A closed wound is one with internal damage to bones or tissue without a connecting wound in the outer skin. Sprains, strains, dislocations, and certain fractures are closed wounds.

4-2. Relief of Pain

Some pain occurs after most wounds. Pain may be mild or severe, depending upon the patient and the wound. The patient's state of mind at the time of wounding will have some effect on the degree of pain. Fear and apprehension, for example, make it worse. To some patients the fear of pain is more real than the pain itself. You must decide whether or not the relief of pain is in the best interest of the patient. In many cases, pain is a helpful symptom to medical personnel. Pain is nature's alarm system; silencing it may be detrimental to the patient.

a. You can give him some relief in these ways.

(1) *Positioning*. The best position is the one which the patient finds most comfortable. Positioning the injured part to relieve stress can do much to relieve pain.

(2) *Reassurance*. Talk to him reassuringly. Make him feel that he is in good hands and more help is on its way. The best type of reassurance is for you not to panic and to act as if everything is under control.

(3) *Medication*. Administer an analgesic such as aspirin or APC. If oral medications and fluid are not contraindicated, aspirin is an outstanding drug and will relieve all but the most severe pain.

b. If the pain is extremely severe, you may have to give morphine if it is not contraindicated (para 4-3d).

4-3. Use of Morphine

a. Morphine is the best pain relieving medicine you have, but it has several dangerous toxic effects. It is a powerful depressor of the central nervous system, greatly reducing respiration and pain

sensation. Also it causes vomiting, dry mouth, constipation, and retention of urine. It must not be given by anyone who is not fully aware of its dangers. Never let morphine out of your possession. It may be stolen for personal use or sale on the black market.

b. Morphine is supplied to you in 16 mg. (one-fourth grain) syrettes. The number of syrettes you carry is determined by your medical commander on the basis of the tactical situation, availability of evacuation, supply, and your ability to administer it intelligently. You must know the indications and contraindications for its use. If not you may do more harm than good. (Contraindication is any condition which makes a particular treatment undesirable or improper.)

c. Morphine is *indicated* for severe pain especially when the evacuation lag time is more than 20 minutes. In a tactical situation where a psychotic patient must be temporarily silenced or sedated, and no other tranquilizers are available, one syrette of morphine is often effective in controlling such a patient. This is an emergency measure only. There are better, nonaddicting drugs for psychosis than morphine.

d. Morphine is *contraindicated* when its toxic effect will compound an injury to a dangerous degree. Do not give morphine to: patients who are to be quickly evacuated, who have chest injuries, depressed respiration, or injuries of the head. Never give morphine to an unconscious patient. Do not give morphine before surgery. If there is a probability that the patient may soon be operated on, he should not get morphine. Both morphine and surgical anesthesia depress respiration. If the patient is in shock, you should not give him morphine because it will not be absorbed due to poor circulation. (Medical officers sometimes administer morphine intravenously while the patient is in shock. Never should you try to give morphine intravenously. If it is given too fast it will be fatal.) A dose of morphine should not be repeated within 2 hours, or if there is any reason to believe the first dose has not been absorbed.

4-4. Treatment of Open Wounds

Control of hemorrhage, relief of pain, and prevention of infection are the main considerations in treating wounds in the field.

a. Acute loss of blood may lead to shock, and shock may lead to death. So, you should do all you can to prevent loss of blood. The preferred method of controlling bleeding is with a pressure dressing securely applied. Lost vascular fluid (blood) or body fluid (tissue fluid) should be replaced. Use oral or intravenous fluids as prescribed in paragraph 3-12.

b. Some wounds are more painful than others. In some traumatic amputations there may be relatively little initial pain, while

in smaller wounds the pain may be severe. Second degree burns and massive tissue wounds involving many nerves are initially painful. Nearly all wounds cause some pain. Things you can do to relieve pain are described in paragraphs 4-2 and 4-3.

c. Any combat wound must be considered contaminated. The best way to prevent more contamination is to cover the wound with a sterile dressing. Combat wounds are "dirty" wounds. All contain bacteria. In the field, there is no way for you to cleanse a wound of bacteria. Pouring antiseptics into a wound will not kill all the bacteria and may be harmful. Pouring antiseptics on the skin around a wound does little to keep out bacteria and should be avoided. When possible, and when evacuation is impossible or delayed for longer than several hours, gentle cleansing of the skin around the wound with soap and water may be helpful.

4-5. Factors Affecting Infection

Infection of a wound involves the number and type of pathogenic organisms entering the wound, condition of tissue in the wound, and the body's defense.

a. If the number of organisms is extremely large, they may overwhelm the body's defense by sheer numbers. This is likely to happen in wounds caused by booby traps with filth and contamination about them. Punji stake wounds are another example.

b. Some organisms are more toxic than others. For example, the organisms that cause gas gangrene and tetanus are deadlier than some organisms that form pus.

c. A cleanly cut wound is not as apt to become infected as a torn, jagged wound. In the first type of wound, blood tends to flush out organisms and they have few places to hide and become imbedded. The second type of wound gives organisms devitalized tissue to hide in and has much less flushing action by bleeding. A puncture wound is most likely to become infected with tetanus and gas gangrene because of lack of oxygen. Penetrating and perforating wounds are usually heavily contaminated by foreign material carried into deep parts of the body. Penetrating abdominal wounds often permit contaminated intestinal contents to leak into the cavity.

4-6. Treatment of Closed Wounds

a. *Sprain.* A sprain is the twisting, tearing, and stretching of ligaments around a joint. Ligaments are strong, slightly elastic, fibrous bands of tissue that hold bones in position. A ligament can be over-stretched and some of its tissue cells injured, or it can be torn loose from its attachment to the bone. An injured ligament heals slowly and sometimes never entirely returns to normal. Diagnosis is made by the presence of a tender, painful joint with

swelling. Fracture also must be considered a possibility with these findings.

(1) A sprain is treated so as to temporarily replace the function of the ligaments by supporting the joint while allowing some movement. You carry elastic rolled bandages for this purpose. A figure-of-eight bandage around the joint should allow the patient to complete his immediate mission. The bandage should be adjusted as swelling occurs. Have a medical officer evaluate the patient after mission.

(2) Analgesics may be given for pain.

(3) Routine evacuation may be indicated.

b. Strain. A strain is an overstretching of a muscle or the muscle's tendon. In combat, some muscles will be forced to function long after they are tired. This results in acute muscle fatigue or muscle strain. Diagnosis generally involves finding tender, painful muscles. Swelling is uncommon.

(1) There is little you can do to treat a strain in the field. The patient needs rest with just enough exercise to keep the muscle from getting too stiff. You cannot provide this type of treatment in the field.

(2) Analgesics may be given for pain.

(3) Heat and massage are also very helpful.

(4) If the strain is severe, routine evacuation is indicated.

c. Dislocation. A dislocation is the displacement of one of the bones forming a joint. A joint is the articulation of two or more bones. When one end of a bone forming a joint is forced out of its articulation, it is dislocated. The dislocation may be incomplete and temporary. In other words, it may jump out of and back into normal position, resulting in a condition much like a sprain. If the bone dislocates from its articulation and remains out of place, it is a complete dislocation. Damage to surrounding blood vessels and nerves may result.

(1) You should not try to reduce a complete dislocation in the field.

(2) Analgesics should be given for pain.

(3) Immobilization of the joint in the position of least pain may be helpful. Usually that is the position in which you find it.

(4) Routine evacuation is indicated unless damage to blood vessels or nerves is suspected because of paralysis, numbness, or absent pulse. In that case, priority or even urgent evacuation may be necessary.

d. Fractures. For treatment of fractures, see paragraph 4-7.

4-7. Fractures

Fractures, or broken bones, are the result of a strong blow or stress against the body causing one or more bones to crack or

break completely. Fractures are either closed (no break in the skin) or open (skin broken). Open fractures are generally more serious, because of the danger of infection.

a. Diagnosis. The patient with a broken bone is almost always in pain at the fracture site. He will give a history of trauma or stress and often will state that he felt the bone snap or give way. He typically has great difficulty in moving the part of the body beyond the fracture. As you examine the patient, you will find swelling and tenderness at the fracture. The broken limb may be obviously deformed. Ultimately, X-rays will be needed to establish the diagnosis and extent of the fracture.

b. Treatment. As with any wounded patient, the first thing to do is save his life. Make sure he has a clear airway and can breathe. Stop external bleeding. Almost every fracture is accompanied by significant internal bleeding. A fractured femur, for example, may involve loss of as much as 1,500 cc. of blood into the thigh. Plainly, then, a patient with a fracture of a major bone is in danger of developing hemorrhagic shock. Therefore, intravenous solutions should be started as soon as possible on any patient with a fracture of a major bone. Place a dry sterile dressing over the wound if it is an open fracture. Administer analgesics for pain. The patient must be evacuated, but the category depends upon the seriousness of the fracture.

c. Splinting. Do not attempt to reduce or set a broken bone. In general, splint the fractured limb as you find it, checking the pulse beyond the fracture before and after splinting. If the pulse disappears after the splint is applied, it is on too tight and must be loosened. Also a record of nerve function distal to the fracture should be made. If the fractured limb is bent so that it pinches off the blood vessels, you may straighten it carefully as long as no force is needed. Never try to force an arm or a leg to lie straight. Splinting is extremely valuable because it prevents further damage to surrounding tissues by the broken bones. Also, splinting helps to reduce bleeding and pain.

d. Splints. Splints and splinting in the field will pose some problems. You do not carry splint sets, such as the Army leg splint set. You may carry the wire fabric splint. Some aidmen carry two wire ladder splints wrapped around the outside of the aid bag as in figure 4-1. To support missions where fractures might occur, you may carry a few pneumatic splints. The ones used most in the field are improvised and anatomical splints (fig 4-2).

(1) An improvised splint is made of any rigid material that is readily available. Parts of the patient's gear are often the handiest material you can use. Rolled or folded, the patient's poncho makes a good splint. So does his rifle when rolled in a jacket. (Be



Figure 4-1. Wire ladder splints wrapped around an aid bag.

sure the rifle is cleared.) Poles or branches from trees also can be used to make splints.

(2) How much time you can spend on improvising a splint will depend upon the tactical situation. There may be instances where you have no time to improvise a splint. In that case, for a fracture of the forearm, quickly place the arm inside the jacket and tuck the jacket as tightly as possible. A fracture of the upper arm could also be treated this way or with a sling around the neck to the wrist. For a fracture of the leg, quickly tie the broken leg to the uninjured leg. This is an example of an anatomical splint, where one part of the body is used to help immobilize another part.

(3) The wire fabric splint is useful in supporting a massive tissue wound. It can be fashioned to help support a broken ankle, wrist, or small bone.

(4) The wire ladder splint can be used for a fractured arm or leg or to support a massive tissue wound. You should control the bleeding before applying a splint. If not, put on the splint so it can be removed easily and quickly.

(5) A pneumatic splint (fig 4-3) is inflatable and made of transparent plastic. You blow air into it by mouth to get the necessary rigidity. Do not use any other means for inflation (such as a tank of compressed air). The splint requires no padding and it can be inflated or deflated as desired. The splint should not be

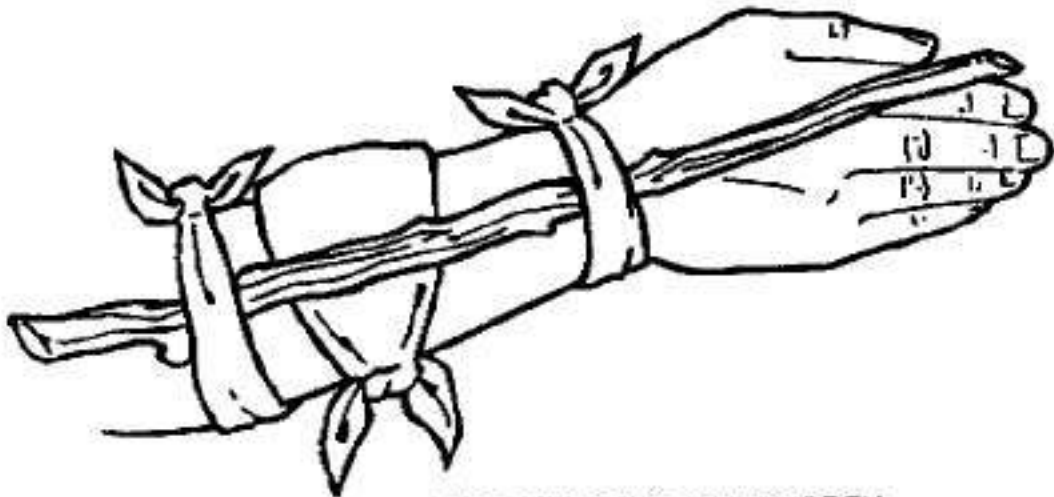
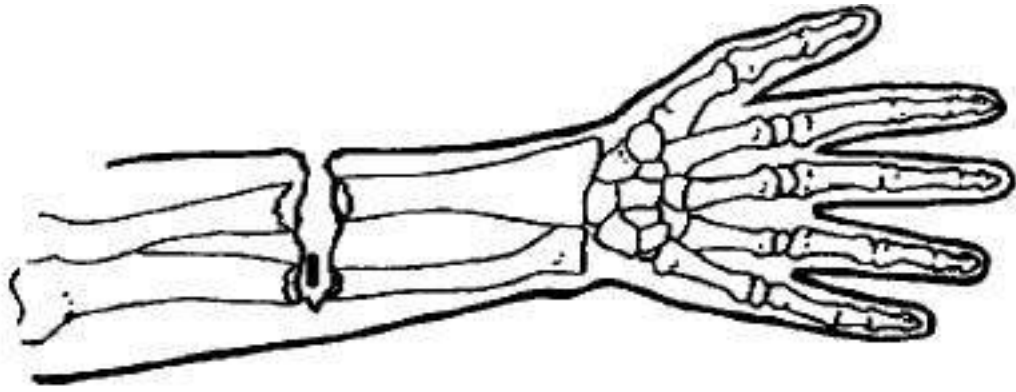

DRESSING AND IMPROVISED SPLINT ON OPEN FRACTURE (MORE RIGID MATERIAL AND MORE TIES IF AVAILABLE).

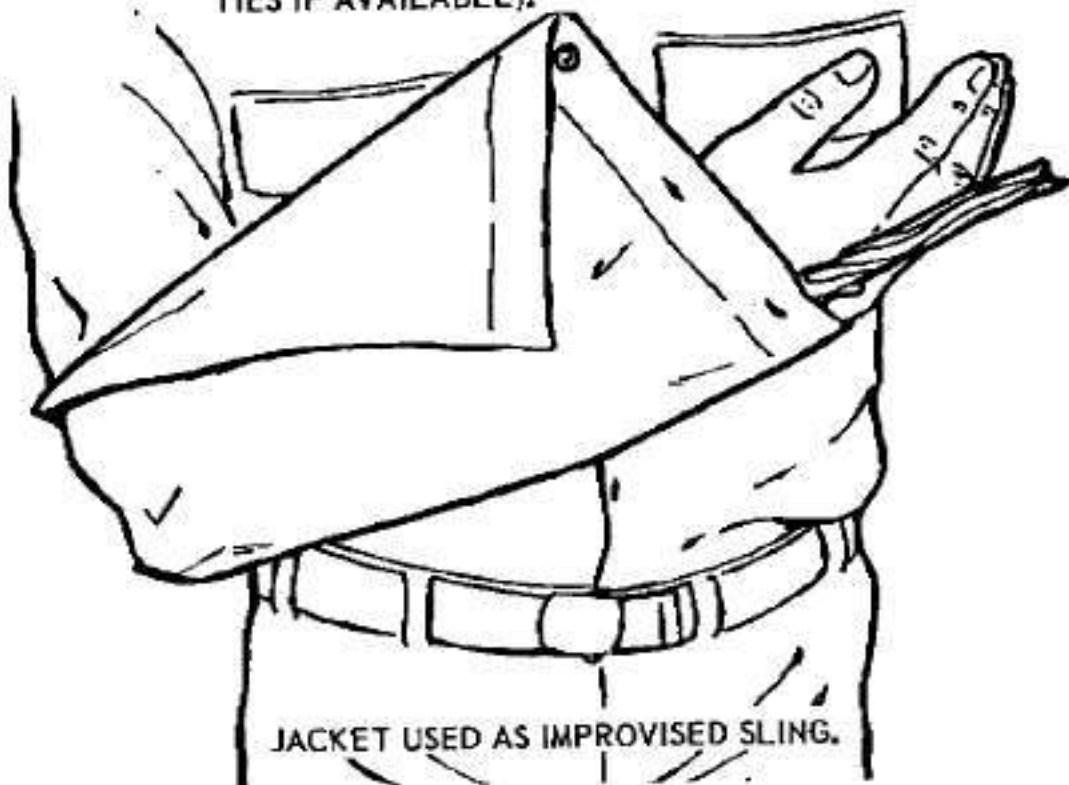

JACKET USED AS IMPROVISED SLING.

Figure 4-2. Examples of improvised and anatomical splints.

inflated and left on the patient more than 30 minutes at a time. To do so will interfere with peripheral circulation. Reduction of peripheral circulation for a long time causes tissue anoxia, which in turn results in damaged or necrotic tissue. Tissue damage is proportional to the duration of diminished peripheral circulation and the degree of tissue anoxia. Therefore, if the patient must wear a pneumatic splint for an extended time, partially deflate it every 20 to 30 minutes for a few moments to reestablish peripheral circulation if it appears that the blood supply to the extremity has been impaired. Do not use these splints unless you have time to check the patient every few minutes.

(6) Army leg splint sets are stocked at aid stations, clearing stations, dispensaries, hospitals, and medical depots. If time and the tactical situation permit, you may ask the evacuation vehicle operator to bring you an Army leg splint if its application is indicated. This splint is especially valuable in protecting the nerves and blood vessels.

4-8. Dressings

A dressing is a pad that is applied directly over a wound. A prepared dressing is usually made of gauze but it can be made of any



Figure 4-3. Inflated pneumatic splint applied on a patient's arm.

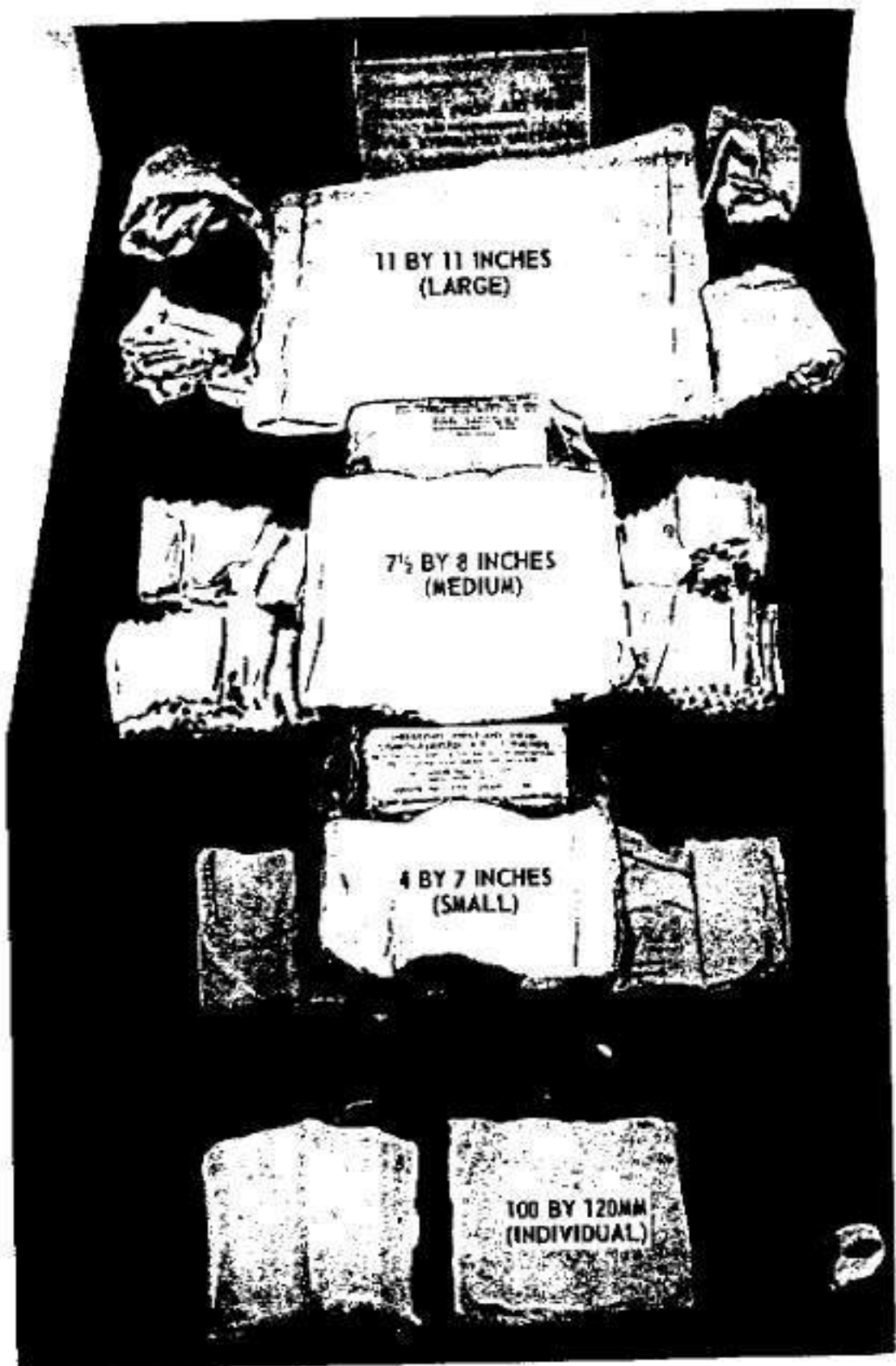

Figure 4-4. Popular sizes of field dressings.

is to control hemorrhage and protect a wound against further contamination. Almost all external bleeding can be controlled with a correctly applied field dressing.

a. *Sizes.* The most popular sizes of field dressings, shown in figure 4-4, are described below.

(1) *Dressing, first aid, 4 by 7 inches.* This small field dressing is the one you probably will use most. You should carry a plentiful supply of these. Many aidmen carry two aid bags, one filled with dressings and one containing other items. Be sure each soldier carries at least one small field dressing.

(2) *Dressing, first aid, field, 7½ by 8 inches.* This is usually called the medium field dressing. The average aidman carries two of these. They are used often to reinforce the small field dressing.

(3) *Dressing, first aid, field, 11 by 11 inches.* This is the large field dressing. You usually carry one of this size. Most aidmen prefer to carry more small dressings and use two or three small ones instead of one large dressing. You can contour two or three small dressings better than a large one. Large dressings are best for extensive burns.

(4) *Dressing, first aid, field, individual troop, 100 by 120 mm.* This is a two-piece dressing designed to allow one gauze pad to slide along the affixed bandage. One purpose of this adjustable dressing is to allow application of the dressing over a perforated wound of an extremity to cover the wounds of entrance and exit with the same dressing. This dressing is smaller and more versatile than other field dressings.

b. *Application.* A field dressing has strips of gauze bandage attached to it. The gauze strips or tails are used to secure the dressing and to apply pressure. First, put a small dressing over the wound and tie the bandage tails firmly over the dressing to apply pressure. If the first dressing does not control bleeding, apply a second one over it. Again, tie the bandage tails firmly. Several small dressings are more effective than one large dressing for controlling hemorrhage.

4-9. Bandages

A bandage is a piece of material used to cover a dressing, apply additional pressure, or immobilize a part of the body. Bandages may be made of gauze, muslin, or elastic cotton (fig 4-5). They may be rolled or folded. Most aidmen prefer to carry a few elastic rolled bandages about 3 inches wide. Elastic bandages are used to reinforce dressings in the control of hemorrhage and to support ankles and knees. Rolled gauze bandages are not often used in the field. Triangular muslin bandages are sometimes used for support but are used most as tourniquets. Folded triangular bandages (cravats) are useful in applying improvised splints.

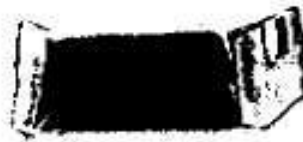

BANDAGE, MUSLIN, 37 BY 37 BY 52 INCHES.

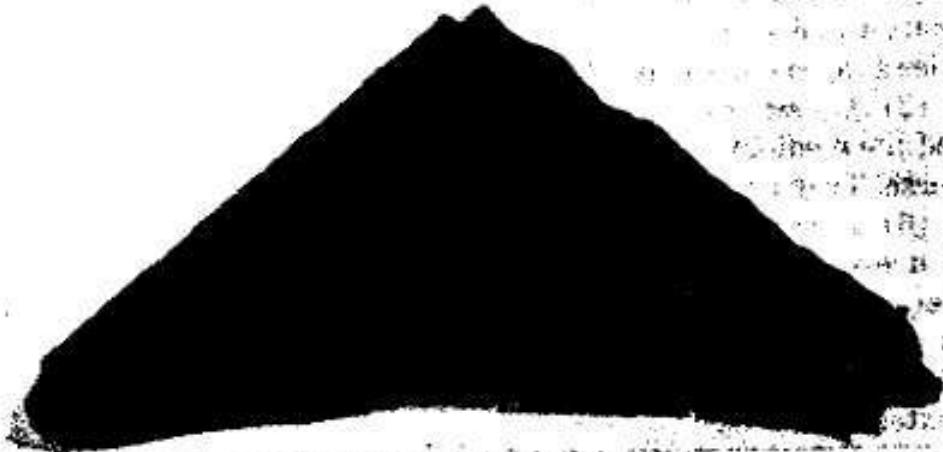

BANDAGE, TRIANGULAR (MADE FROM BANDAGE, MUSLIN).



BANDAGE, CRAVAT (MADE FROM BANDAGE, MUSLIN).



BANDAGE, COTTON, ELASTIC

Figure 4-5. Bandages for field use.

addition, pupils of unequal size and vomiting are signs of brain injury even if the skull is not fractured.

b. Do not give medication to a patient with a head injury. The medication may mask the symptoms of a more serious injury. Observe the patient carefully, paying particular attention to his vital signs and state of consciousness.

c. Routine evacuation is indicated for simple head injuries if there is no firm evidence of skull fracture and the vital signs and state of consciousness are stable.

d. If you can feel a fracture, or if you see the clear cerebrospinal fluid coming from the patient's nose, ears, or wound, or if you see brain matter in the wound, or if the vital signs or level of consciousness deteriorate, evacuate the patient by the proper category of precedence. In this case, that would be probably priority or urgent. If an external wound is present, apply a loose-fitting dressing. Again, give no medication.

e. The most important thing you can do in the treatment of head wounds is record the injury. Record the time of the wounding and all signs and symptoms. Make particular note of vital signs, size of pupils, and state of consciousness both when you first began treatment and at the time of evacuation. Also record the time of your observation.

5-4. Intracranial Wounds

Intracranial wounds are serious because they involve the brain and other tissue inside the skull. There are two general types of intracranial wounds, open and closed. In the open type, the brain is exposed to the outside and there is a laceration of the scalp as well as a skull fracture. In the closed type, there is no opening from the brain to the outside. Either type will pose problems for you. For a severe open head wound, you should apply a dry, sterile dressing and call for immediate evacuation using the urgent category of precedence. The closed head wound poses special problems. You have no immediate way to determine the degree of injury. Therefore, you should do the following things:

a. Observe the patient closely.

b. Record the time of the injury.

c. Check the patient every few minutes for headache, changes in size of pupil of the eyes or in their reaction to light, impairment of vision, dizziness, slurring of speech, changes in pulse rate, vomiting, or changes in rate of respiration. Be sure to record these symptoms and the time of their onset. They indicate that brain injury is developing, usually from slow bleeding inside the skull. Always record at least one observation of pupil size and pulse rate in case of a head injury.

d. Request a priority category evacuation for the patient if any of these symptoms appear.

e. Advise the patient's commander not to plan on using the patient for critical or sensitive duties while he is being observed.

f. Give no medication during the period of observation. Observation should last about 24 hours. Occasionally the bleeding inside the skull can be very slow, with the symptoms taking several days to develop. The patient's commander should be alerted to this possibility.

5-5. Wounds of the Face

Facial wounds require prompt, positive action because of bleeding and possible airway obstruction. Airway obstruction is a more immediate threat to life and harder to handle than bleeding. Blood clots and pieces of bone, flesh, or other foreign material may block the airway. Blood which is swallowed may cause vomiting and the vomitus may be aspirated, further complicating the problem. Attempts to control bleeding may interfere with breathing. The patient may be trying frantically to get air. Do these things immediately.

a. Position the patient so that he will not aspirate fluids if he is bleeding from the mouth or vomiting.

b. Clear the airway of blood clots and foreign matter. Wrap a piece of gauze bandage around your fingers when you dislodge blood, vomitus, or mucus from the airway. Gauze makes it easier for you to grasp things.

c. Prepare to perform an emergency surgical airway. Due to aspiration of foreign matter, the patient will be hard to manage and he will remain in danger of aspirating more foreign matter until bleeding is controlled. It may become necessary to perform an emergency surgical airway (para 3-10) to relieve airway obstruction before full attention can be turned to control of bleeding from the facial wound.

d. Call for evacuation early. Facial wounds become progressively worse. Airway difficulties get worse with swelling of injured tissue. Bleeding is hard to control, injured tissue becomes more painful, and it is almost impossible to prevent infection. Collect all pieces of dentures, if any, and evacuate them with the patient. They can be valuable aids in treatment and reconstruction.

5-6. Wounds of the Neck

Wounds of the neck are treated essentially the same as facial wounds. Airway obstruction and hemorrhage are the main threats to life. Hemorrhage from large blood vessels must be controlled quickly. Direct pressure with a pressure dressing must be applied

over the bleeding point, alongside but not over the trachea. Take these actions or precautions immediately.

Caution. Beware of a possible fracture!

a. Position the patient quickly to prevent more blood from entering the airway.

b. If large blood vessels are severed, apply direct pressure quickly.

c. Call for assistance; the patient will be difficult to handle.

d. Clear the airway as rapidly as possible. Consider a surgical emergency airway early.

e. Due to aspiration of large amounts of blood, the airway may be blocked. After clearing it, start artificial respiration if spontaneous respiration does not occur.

f. Call for evacuation early and request delivery of necessary resuscitative equipment.

g. In severe hemorrhage, start blood volume expanders promptly.

h. Handle the patient very gently if you suspect he has a fractured neck. Immobilize the neck as much as possible.

i. Do not give morphine.

j. Do not give anything by mouth, as the esophagus may be injured.

5-7. Chest Wounds

Chest wounds represent an appreciable proportion of combat wounds. Most fire is directed toward the chest. Penetrating and perforating wounds of the chest may damage the lungs, trachea, bronchi, esophagus, diaphragm, or large blood vessels. Most chest wounds interfere with breathing.

a. The normal chest cavity is an airtight enclosure with one opening to the air, the trachea. If another opening into the chest cavity is made, such as a bullet wound through the chest wall, the lung on that side of the chest can no longer remain expanded and is said to "collapse." With each breath, air is sucked into the chest cavity, permitting the lung to deflate further. This is called a "sucking chest wound." The more the lung collapses the less well the patient can breathe. Therefore, the sucking chest wound must be *sealed* shut as soon as possible by any means available.

(1) The best way is to place several thicknesses of petrolatum-impregnated gauze over the wound and reinforce it with a field dressing, as in figure 5-1.

(2) A field dressing (first aid dressing) may be placed over the wound. Then, the dressing should be covered with airtight material to produce a quicker airtight seal over the wound.

(3) A piece of airtight material such as cellophane, plastics,

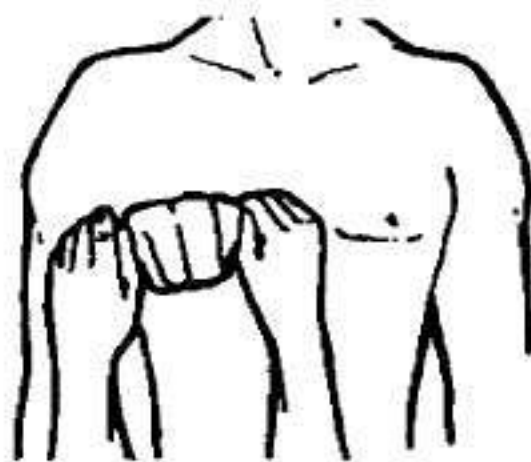

PETROLATUM GAUZE OVER SUCKING CHEST WOUND



DRESSING OVER PETROLATUM GAUZE

BANDAGE OVER GAUZE



Figure 5-1. Treatment of a sucking chest wound.

or poncho placed directly over the wound is effective as long as it is held firmly in place. These materials tend to slip and leak as blood seeps under them.

(4) All sucking wounds must be sealed. The test of successful sealing is in the patient's ability to breathe easier and the cessation of bubbling or hissing at the wound during respiration.

b. Flooding of the chest cavity by internal bleeding can also collapse the lungs. If all wound openings are closed and the patient still has difficulty, you can assume he has internal bleeding or massive lung damage. If the patient begins to present a shock picture, internal bleeding should be suspected. If he begins to hemorrhage from the mouth, he is critical. Then, the following measures are used.

(1) Place the patient in the best breathing position. If possible, the wounded side should be placed down to increase breathing of the unwounded side.

(2) Start intravenous infusions of Ringer's lactate solution or other blood volume expanders.

(3) Keep the patient as still as possible.

(4) Urgent evacuation is indicated.

5-8. Abdominal Wounds

A wound of the abdomen can be misleading. What appears to be a small, insignificant wound on the outside may be a massive, bleeding wound on the inside (fig 5-2). All penetrating and perforating abdominal wounds require exploratory surgery to stop bleeding. Abdominal wounds may include damage to the stomach, pancreas, intestines, spleen, liver, kidneys, or large blood vessels. The early cause of death is uncontrolled bleeding. Infections, especially those of the internal abdominal lining (peritonitis), caused by injury to the intestines or by the wounding agent itself, may complicate the case later.

a. *Signs and Symptoms of Internal Abdominal Bleeding.*

(1) Any perforating or penetrating abdominal wound.

(2) Pale skin and weak, rapid pulse.

(3) Thirst, restlessness, and apprehension.

(4) Abdominal rigidity (board-like).

b. *Actions You Should Take Immediately.*

(1) Instruct the patient to remain as still and quiet as possible.

(2) Call for urgent evacuation.

(3) Start intravenous infusions of Ringer's lactate solution or some other blood volume expander.

(4) If the patient's organs are protruding, do not try to replace them.

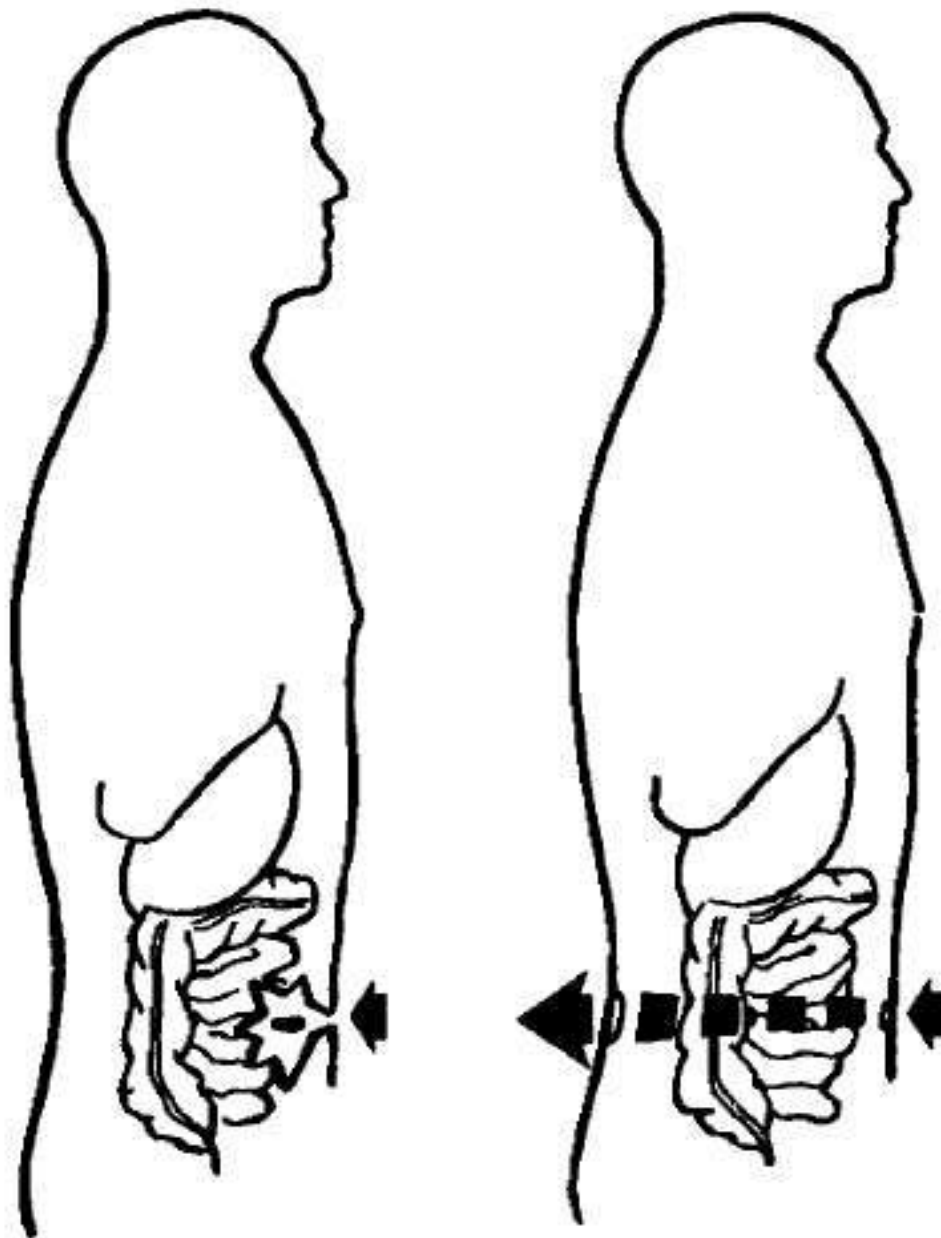

Figure 5-2. Abdominal wound.

(5) Cover the wound loosely with a dry sterile dressing.

(6) Allow the patient to take *no* food or drink by mouth. Give no oral medication.

(7) For a closed abdominal wound (blunt trauma), give no medication for pain because it might disguise the symptoms needed for diagnosis. If the wound is open and there is no breathing trouble or head injury, morphine may be given by injection for pain.

5-9. Traumatic Amputations

Most traumatic amputations are caused by exploding antipersonnel mines, land mines, and booby traps. Fragments thrown out by

any of these devices can amputate an arm or a leg. High velocity bullets can cause a partial amputation. In treating a patient with a traumatic amputation, you must do these things immediately.

a. Expose the entire limb above the wound by removing or cutting off the clothing. Inspect to confirm the extent of damage to remaining tissue.

b. Apply a tourniquet at once. Often, if the entire extremity is completely torn off, bleeding will be slight. This is due to the partial retraction of arteries and contraction of muscles acting like a tourniquet. Even if bleeding is slight, apply a tourniquet because, in a few minutes, the muscles will relax and bleeding will start.

c. The best field tourniquet is made with a cravat bandage and a stick. As in figure 5-3, place the tourniquet about 2 inches above the end of the stump or incomplete amputation. Tighten the tourniquet until all bleeding stops. Secure the tourniquet (fig 5-3) so that it is easy to remove or to tighten.

d. Cover the stump or incomplete amputation with field dressings. The dressings keeps the wound clean and gives you a visual check on bleeding. If the dressing becomes soaked with blood, check the wound or inspect and adjust the tourniquet. Do not apply a roller bandage at this time; it would interfere with the tourniquet.

e. If the amputation is incomplete, put a splint on it. The tissue splinted should be positioned in approximate anatomical alignment to avoid further damage to splinted parts of the limbs. Tissue below the probable amputation can be saved sometimes and used later in making the stump. A temporary improvised splint that is easy to remove is adequate. Apply the splint so that the tourniquet can be adjusted without much trouble.

f. At first, the pain should be slight to moderate. Severe pain may develop later, in 30 minutes to 2 hours. Morphine is not indicated unless the pain is severe.

5-10. Burns

Burns are damage to tissue caused by exposure to excessive heat, strong chemicals, or electricity. They are classified by cause, degree, and extent. All classifications should be considered in the treatment and disposition of a burn patient. Burns are complicated by airway blockage, carbon monoxide poisoning, lung damage, shock, and infections. Most people who die immediately in a fire die from suffocation. Those who die a few hours later usually die of shock. Those dying 3 to 10 days after the burn usually die of infection. Other factors complicate burns but you can do little in the field to prevent them. Your first job is to treat those life-threatening conditions which follow burns.



APPLY TIE TWO
INCHES ABOVE
WOUND.

INSERT STICK

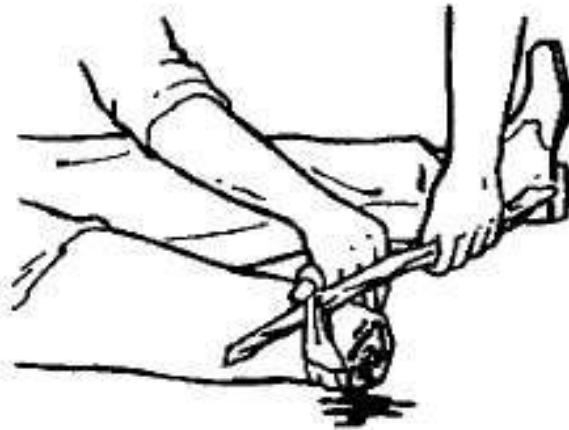

TURN STICK UNTIL
BLEEDING IS CONTROLLED.

SECURE STICK.

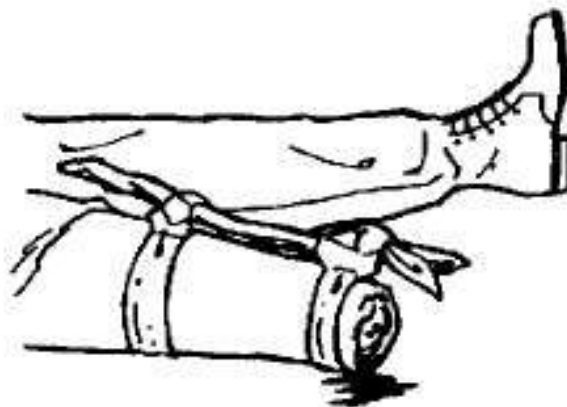

Figure 5-8. Application of Spanish windlass tourniquet to a traumatic amputation.

a. Airway difficulty and carbon monoxide poisoning are the most immediate threats to life. These conditions may have several causes.

(1) Edema of the tissue of the air passages is due to burns from inhaled hot gases. Swelling of the lips and mouth indicates other tissues farther down the airway are probably swollen. This swelling may block the air passages and suffocate the patient. An emergency surgical airway is then indicated. The surgical airway should be made before the air passages are completely closed.

(2) Inhalation of carbon monoxide is a threat even if the patient is not burned. Burning material consumes oxygen and produces carbon monoxide, a poisonous gas. A patient who has inhaled carbon monoxide will exhibit a sensation of suffocation, cherry red flush, and possibly coma. If the patient inhales carbon monoxide, you may need to perform artificial respiration for prolonged periods of time. Also request the evacuation vehicle to bring oxygen and resuscitating equipment to supplement treatment.

(3) Smoke inhalation irritates the air passages and delicate membranes of air sacs in the lungs and can result in a form of pneumonia. When the patient has inhaled such irritation or poisonous material, his lungs must be flushed out with fresh air or oxygen as fast as possible. If the patient is conscious, he can flush the fumes out himself by deep breathing and coughing. If he is unconscious or uncooperative, artificial respiration should be given to force deep breathing. Request the evacuation vehicle to bring resuscitative equipment for use in supplementing treatment. Artificial respiration also will be needed if the patient does not breathe on his own.

b. Shock is another serious threat to life in a burn patient. When extensive areas of skin are burned, the patient cannot properly control loss of body water. If 30 to 40 percent of the body surface receives second or third degree burns, the body will lose 6 to 7 liters of water in 24 hours. If this tissue fluid is not replaced, shock is certain to occur. Since tissues begin to lose fluid as soon as a burn occurs, the sooner fluid replacement is begun, the better. Fluids may be given orally or intravenously. If large areas of the body are covered by second or third degree burns, you should start two or more I.V.'s. Use fluids as directed in paragraph 3-12. Ringer's lactate solution is the best I.V. and may even be given orally if tolerated. To prevent burn shock, start fluid replacement early, both orally and intravenously.

c. Infection is the third cause of burn deaths. It is a late complication, but the organisms causing the infection may enter early after the burn. You should take every reasonable precaution

to prevent this. Apply only dry, sterile dressings over the burn. If you do not have dry, sterile dressings, leave the burn open. Do not cough or sneeze over the burn. Do not pass your hands over the burn any more than is necessary. Do not place a blanket over the burn patient unless the weather is extremely cold. Do not apply medication to a burn. It does little good and when it is removed it will cause the patient much pain. In particular, do not apply greasy substances such as butter, olive oil, or suntan lotion as these will predispose to infection and do no good. The only material presently acceptable for application to the burn surface besides the dry sterile dressing is Sulfamyalon burn cream.

5-11. Chemical Burns

Acids, alkalis, and other strong chemical agents damage the skin, causing chemical burns. A common chemical burn is that caused by white phosphorus, a fast-burning metal used in marking rounds and incendiary grenades. When detonated, the white phosphorus is blown into small pieces. Each particle of phosphorus burns rapidly when exposed to air. Particles striking a soldier will imbed in or stick to his skin and clothing and continue to burn. His clothing may ignite, causing more burns. The only way to stop the phosphorus from burning is to exclude the air (oxygen) from it. Copper sulfate pads are designed to extinguish burning phosphorus. Apply water to the copper sulfate pads and place over the burning phosphorus while wet. If the pad dries out, apply more water; the pad must be kept wet. If you do not have copper sulfate pads, mud is a good substitute. You can wet gauze, but it must be kept wet or it too will ignite, producing more burn. As soon as the phosphorus is extinguished, remove the particles if they are not imbedded too deeply. After removing the particles, cover the burn with a dry, sterile dressing. *Never* use copper sulfate pads as a dressing. If you cannot remove the particles, notify the evacuation vehicle so that additional copper sulfate may be brought for in-transit treatment. For safety of the evacuation vehicle, all patients with white phosphorus burns must be monitored carefully, because a burning piece of phosphorus may ignite the evacuation vehicle. Other chemical burns must be flushed with water to wash away the chemical, then treated as any other burn.

5-12. Evacuation of Burned Patients

To determine category of precedence (para 2-8) for evacuation, you need to know how to classify burns according to their severity. Severity classifications are minor, moderate, and severe. The severity of a burn is determined by the extent of the burn and the degree of the burn. Extent means area. Degree means depth. Burns about the head, face, neck, or chest are severe and the

patient with such burns should be evacuated in the urgent or priority category because of possible airway complications.

a. Minor burns include first degree burns of any extent and second degree burns of small area. Moderate burns include second degree burns of less than 10 to 20 percent of the body surface and small third degree burns. Severe burns are those in which 20 percent or more of the body surface is covered with second or third degree burns. The "rule of nine" is useful for calculating percent of body surface burned. Roughly, these are the portions of body surface over each part of the body: head 9 percent, each arm 9 percent, anterior trunk 18 percent, posterior trunk 18 percent, each leg 18 percent, groin 1 percent.

b. A first degree burn is one where there is a reddening of the skin as in sunburn. A second degree burn is one with blistering of the skin. A third degree burn is one with charring or complete destruction of tissue. At times, in the absence of charring it may be difficult to determine if a third degree burn is present. Some third degree burns have the appearance of leather, or horsehide as on a baseball. As third degree areas have lost their nerve supply, they are insensitive to pain.

c. As a general rule, patients with minor burns should be evacuated in the routine category. Frequently, they need not be evacuated at all. Moderate burns should be evacuated in the priority category. Severe burns should be evacuated in the urgent category.

CHEMICAL, BIOLOGICAL, AND NUCLEAR CASUALTIES

6-1. Problems of the Aidman

Casualties produced by chemical, biological, or nuclear operations could pose many problems for you as aidman. The number of casualties will be large. Material to work with will be in short supply. Evacuation will not be available for many casualties. You will have to be able and ready to advise the local commander on the combat capabilities of his troops. Your determination of men's capabilities will be influenced by the tactical situation.

6-2. Casualty-Producing Chemical Agents

The chemical agents that can be used to injure or to kill men are nerve agents, blister agents, blood agents, and choking agents. You need to be familiar with the characteristics and modes of actions of these agents so that you can prepare for the prevention, tentative diagnosis, and treatment of casualties they produce. Nerve agents and blister agents are the ones you are most likely to encounter.

6-3. Nerve Agents

Nerve agents are lethal (fatal) because they are extremely toxic organic compounds. They can cause death or disability in minutes. They are essentially odorless and colorless. They range in persistency from those which are highly volatile with low persistency, such as standard agent GB, to those with low volatility and high persistency, such as standard agent VX.

a. One of your duties is to indoctrinate the troops in first aid and buddy aid for nerve agent poisoning. The soldier and his buddy must be able to recognize the primary signs and symptoms of nerve agent poisoning. Self-aid and buddy aid can save lives and reduce morbidity. Treatment cannot be started until a man recognizes something is wrong; after recognition, he will probably have to start treatment himself.

b. After local exposure to nerve agent vapor or aerosol, the pupils of the eyes will be pinpointed. If exposure has occurred through the skin or by ingestion, the pupils may be normal or slightly to moderately reduced in the presence of severe systemic

symptoms. Increased production of secretions results in a running nose and excessive salivation. Tightness in the chest results from constriction of the airway with increased secretions in the tracheobronchial tree. Nausea, vomiting, diarrhea, muscular twitching, drooling, and sweating may occur. These symptoms may progress to convulsions, coma, and death. Respiratory failure is the usual cause of death.

c. Immediately after exposure to a nerve agent, the soldier should hold his breath, put on the protective mask, and clear it. Then he should decontaminate his skin and give himself atropine if he has impaired vision, excessive salivation, trouble in breathing, or muscular twitching. He should check his buddy for evidence of exposure to nerve agent, then continue his mission.

d. Act immediately as prescribed in *c* above to protect yourself. Then, check all personnel for symptoms of exposure to nerve agent. If you find casualties, give atropine until symptoms are alleviated; see *e* below.

e. There are several vital steps in the treatment of nerve agent poisoning. The protective mask must be put on as soon as a nerve agent is suspected or signs or symptoms of such poisoning are recognized. Liquid contamination must be removed immediately from the skin or the clothing. (A decontamination kit is provided for this purpose.) Contamination of the eyes is treated by irrigation with copious amounts of water. Atropine must be used on the appearance of any sign or symptom of nerve agent poisoning because it blocks the internal effects of nerve agents. Every soldier should carry three automatic injectors or syrettes of atropine. In freezing weather, they should be carried next to the body to prevent freezing. When used, they should be injected into a muscle. The injection may be repeated every 10 to 15 minutes if symptoms of nerve agent poisoning persist. Under the supervision of a medical officer, as many as 10 to 20 or more doses over several hours may be required to alleviate symptoms in severe exposure to a nerve agent. Such a patient requires urgent evacuation. The patient should not be considered adequately atropinized until he is dry and flushed and has a heart rate of greater than 110 per minute. Since atropine's effect is short-lived, the casualty must be observed for recurrence of symptoms. Atropine is not to be used as a preventive before contemplated exposure to a nerve agent.

f. If there is respiratory embarrassment, the casualty may require artificial respiration even after injection of atropine. Airway obstruction must be relieved by proper positioning of the casualty's head, removal of secretions or vomit from his mouth, and establishment of an airway. If possible, artificial respiration (modified Sylvester or mask-to-mouth) should be given by some-

one other than the aidman. You should be available to monitor as many persons as possible as long as the threat of nerve agents is present.

6-4. Blister Agents

The blister agents include mustard (HD), nitrogen mustard, lewisite and other arsenicals, mixtures of mustards and arsenicals, and phosgene oxime. This discussion is limited to mustard (HD), a very persistent and standard blister agent, because it is the most widely considered blister agent.

a. Symptoms of exposure to mustard come from its effects on the skin, eyes, mucosal surfaces, and respiratory tract. Exposure of the skin to mustard is followed by a latent period varying with the weather and the degree of exposure. The casualty shows no symptoms for one to several hours after exposure. Then reddening, itching, or burning will occur, followed by blisters. The blisters are second degree chemical burns. Unless the burned area becomes infected, the blisters will heal in from one week to a few weeks. The redness of blister agent exposure should heal in a few days. Some areas of the body heal faster than others. For example, an uncovered area like the face heals faster than a covered area like the buttocks. Prevention of contamination of these burns should receive as much consideration as for thermal burns. Infected mustard burns are treated the same as second degree thermal burns.

b. Severe internal poisoning with mustard may progress to vomiting, diarrhea, and shock. Treatment before symptoms start is nonspecific. Treatment after the onset of symptoms is supportive. The first step in first aid for blister agents is to put on the protective mask for respiratory protection. If the eyes are contaminated, they should be flushed out with copious amounts of water. No other decontaminant should be used on the eyes. The skin should be decontaminated with the decontamination kit the same as for liquid nerve agent. Blisters are treated the same as second degree thermal burns.

6-5. Blood Agents

The blood agents are systemic poisons of the cyanide group. Hydrocyanic acid (AC) and cyanogen chloride (CK) are the main blood agents. They enter the body through the respiratory tract. The central nervous system, especially the respiratory center, is extremely susceptible to their actions. Symptoms of blood agent poisoning include dizziness, headache, trouble with respiration, coma, cessation of breathing, and eventual death. First aid includes putting on the protective mask and giving artificial respira-

tion. Amyl nitrite may be administered by crushing two ampules and inserting them in the face of the mask.

6-6. Agents Used for Special Effects

Chemical agents such as the choking agent phosgene and the tear agents CS and CN may be used for special effects. For instance, phosgene could be disseminated in an area to induce choking among troops. Then a nerve agent could be dispersed among the choking troops to produce casualties. CS and CN may be used in riot control and to force men out of bunkers and foxholes. First aid for these agents consists mainly of putting on the protective mask and wearing it until tests show the agents are not present. If particles of the agents become imbedded in a man's clothing and emit vapors into his face, he should face the wind so that it will carry vapors away from his face. There are no specific medications or treatments for exposure to these agents.

6-7. Mental Incapacitants (Psychochemicals)

Mental incapacitants, or psychochemicals, are chemical agents which disturb normal behavior patterns. They may cause apathy, fear, disorientation, or confusion or so affect mental processes in other ways that the casualty appears psychotic (insane). The management of troops exposed to mental incapacitants will create problems in command and control as well as treatment. You will have no medications to use in treating these casualties. You may be expected to help the commander in managing, controlling, or making the proper disposition of troops which have become casualties. Men wearing the protective mask while a mental incapacitant is being dispersed will not become casualties.

6-8. Biological Operations

Biological operations employ disease-causing organisms to produce human casualties, damage food-producing animals and plants, and cause premature rot of material. Your actions in treating and disposing of casualties with these diseases are the same as for diseases spread by other means. Your biggest problems are in helping the commander in making proper disposition and evacuation of large numbers of casualties. There is little you can do in giving medications for these diseases, but you can do several things to reduce the effectiveness of the operation. You can indoctrinate the troops in the importance of safeguarding food and water and avoiding contaminated food and water. You can instruct them to practice personal cleanliness, control rodents and insects, take prescribed immunizations, and report illnesses and infections promptly. The health of the troops is the commander's responsibility, but he will rely heavily on you for assistance and on the medical service for support.

6-9. Casualties of Nuclear Weapons

a. The aidman's problems in managing or disposing of nuclear casualties are enumerated in paragraph 6-1. In dealing with these problems, compromises must be made. The normal guides for assigning priorities for treatment and evacuation cannot apply in a mass casualty situation.

b. Detonation of a nuclear weapon will produce casualties of three main types: thermal, blast, and nuclear radiation. Thermal casualties will result from the direct effects of the weapon in the form of flash burns. Other burns—secondary or flame burns—will occur in the exposed unit as a result of ignited clothing and material. Flash burns are expected to be first degree, while flame burns will be characteristically second and third degree. Both types of burns must be reevaluated later, but for initial screening and for advising the commander, flash burns are not expected to produce as many serious casualties as flame burns. The number of burned casualties may not be as great as other types of casualties, but they will require more intensive care and put exceptional demands on medical supplies.

c. Blast can be expected to produce more casualties than any other effects of a nuclear weapon detonation. Missiles flying through the air will produce many, varied types of casualties. Glass and other sharp objects will cause lacerations and puncture wounds. Objects such as bricks will cause fractures and contusions. Persons picked up by the blast and hurled against objects may suffer varied wounds. Blast injuries may range from minor wounds to severe wounds with hemorrhage and shock. Your primary duty is first to locate troopers with minor wounds and return them to some kind of duty. The separation of wounded according to type and severity is called "triage and sorting." Initial triage and sorting must be done by you and the commander until more medical personnel arrive. Since you cannot treat all the casualties, you must train as many fellow soldiers as possible in first aid and buddy aid. The better trained men will be valuable in giving emergency medical care if mass casualties occur.

d. Nuclear radiation is of two types. One type comes directly from the fireball. The other type comes from dispersed radioactive particles after the fireball has dissipated. The total amount of radiation received by an individual is more important to you than is the source of radiation. A small total amount of radiation may have little or no immediate effect. A moderate amount of radiation may produce casualties within a day or so. A large amount of radiation may produce casualties immediately. There is no way you can tell when symptoms will appear. A rule of thumb is to

appear. Nausea, vomiting, and general weakness are the main symptoms you will use in the field to evaluate casualties during the initial screening, triage, and sorting. Radiation injury has no specific treatment and requires long-term medical management and supportive therapy.

COMMON EMERGENCIES

7-1. Foreign Bodies

Foreign bodies are any external objects which may enter the human body. They include shell fragments, bullets, gravel, splinters of wood, and insects. The foreign object may be in the skin, ears, nose, or eyes. The general rule is, if the object can be easily removed, do so; if it is imbedded and difficult to remove, apply a dressing and evacuate the patient.

a. In the Eyes. Foreign bodies in the eyes are common, especially around helicopter and other aircraft operations. Troops are frequently airlifted into and out of operational areas. Aircraft propellers, especially helicopter rotors, kick up dust, grass, or leaves that get into a soldier's eyes, temporarily incapacitating him. The actions for you to take immediately are:

(1) Place the patient in a sitting or squatting position with his head tilted backward against your body to steady him.

(2) Holding the eyelids open with one hand, pour water from your canteen into his eye(s).

(3) If the objects are flushed out, allow him to continue his mission but check on him later.

(4) If the objects do not flush out, lead the patient to a safe area and make a more thorough examination. If the foreign object will stick to a moistened piece of gauze, remove it. If the object is imbedded, do not try to remove it. Apply a dressing over both eyes and have the patient wait in a safe area until evacuation can be arranged. If objects are imbedded in both eyes, apply a dressing over both eyes and evacuate the patient.

b. In the Ears. Foreign bodies that get into the ears are usually insects. Soldiers resting on the ground often complain of insects crawling into their ears. Using a flashlight, you may be able to attract the insect by directing light into the ear. Another thing you can try is to pour water into the ear; that will bring most insects to the surface. At times, in trying to remove an insect, a patient will poke a finger into his ear and imbed the insect in ear wax so that you cannot remove it.

c. When to Evacuate. You should evacuate all patients with

foreign bodies in the eyes, ears, nose, mouth, or skin which cannot be removed easily. You have too few tools to work with and the consequences can be too serious to do otherwise.

7-2. Accidental Poisoning

Accidental poisoning in the field is not common. Occasionally, a soldier will ingest food or drink that makes him violently ill. Unfriendly people have been known to poison troops. A soldier may eat food which is spoiled, thinking strange and exotic food is supposed to taste that way. He can be sickened also by consuming a bottled soft drink, such as coke, to which the enemy has added poison. This is done by removing the cap from the bottle, adding poison to its contents, recapping the bottle, and selling it to a thirsty soldier. Another method of poisoning is through the selling of poisonous alcoholic beverages. A thirsty soldier may be sold a nonpoisonous drink, or two, of an advertised alcoholic beverage, then offered a bottle of what is supposed to be the same or a better beverage. While under the influence of the first one or more "good drinks," he consumes the "better beverage." It can contain one of many poisons, the commonest being methyl or wood alcohol. When an individual complains of stomach pain, nausea, vomiting, or diarrhea after eating or drinking some questionable substance, you should suspect poisoning. First aid is as follows:

a. Dilute and flush out. Encourage the patient to drink plenty of water. Filling his stomach with water dilutes the poison. Instruct him to stick his finger behind his tongue to trigger the gag reflex. If he is unable to do this, you can do it for him to induce vomiting. This process may be repeated once or twice, depending on how much foreign material is flushed out of the stomach. Contents of the stomach come out as a clear liquid when it is clean of foreign material.

b. Get powdered milk if available from C rations and make a canteenful of milk. Have the patient drink as much milk as he can tolerate.

c. Evacuate the patient for further evaluation.

d. Use these same procedures when a patient has swallowed an overdose of medication or drug, but do not flush or cause vomiting if he has swallowed a corrosive agent (acid or alkali).

7-3. Poisonous Plants

Poisonous plants are found in many countries, but are most abundant in areas with heavy foliage. Dense vegetation has plants to which many persons are allergic, such as poison ivy, poison oak, and poison sumac. Skin eruptions and itching may occur hours after exposure. By then the patient may not know which of many

plants cause the condition. You can only treat what you find and caution other loopers to cover their bodies as much as possible. (For specific conditions and treatments, see para 11-9.)

7-4. Snake Bites

Snake bites are unusual, even in snake-infested areas. Generally, a snake will avoid a man unless it is forced to defend itself. If you encounter a snake at close range, do not make any sudden moves. Back away slowly. A snake can strike accurately for a distance equal to about one-half of its length. Both poisonous and nonpoisonous snakes will bite if provoked.

a. Symptoms of poisonous snake bites include the following:

- (1) Pain at the site of the bite. In some cases, pain is immediate and severe. In others, pain may be delayed and slight.
- (2) Immediate swelling and discoloration.
- (3) Early signs and symptoms of shock.
- (4) Headache, dizziness, and blurred vision.
- (5) Impairment of circulation, respiration, and coordination.

b. If bite is on an extremity, place an improvised venous tourniquet or constricting band above the bite and above the swelling. As swelling advances up the extremity, move the tourniquet above it.

c. Immobilize the bitten area as much as possible. Movement speeds circulation within the area.

d. If a medical treatment facility is less than one-half hour away, do not make incisions. If immediate evacuation is not available, proceed to make incisions parallel to the veins over the fang marks about $\frac{1}{2}$ inch long and $\frac{1}{2}$ inch deep. The incisions should *not* cross. Oral or mechanical suction will help in getting drainage. Remember though, that oral suction by an individual with cuts or sores in the mouth endangers him to poisoning. Be sure to cover the wound with a sterile dressing to avoid a secondary infection.

e. If signs and symptoms of shock develop, start an intravenous infusion of any available solution, preferably Ringer's lactate solution or saline.

f. If there are no serious signs or symptoms, treat the symptoms which are present. Hold the patient for observation and routine evacuation.

7-5. Insect Bites

Insect bites are frequent in the field. They may be merely a nuisance or they may be serious. In persons who are extremely allergic to certain insect bites, severe reaction may follow the bites. If a severe reaction occurs, an oral dose or an injection of Benadryl may help to minimize the symptoms. If the reaction is so severe that respiratory difficulty and unconsciousness develop,

epinephrine must be injected (para 7-6b(3)). Artificial respiration may be needed. Urgent evacuation is essential. Itching of a less severe insect bite can be relieved by rubbing tetracaine or another local anesthetic ointment on the skin. Tetracaine ointment could be a useful item for you to carry for men in stake-outs, listening posts, or other places where noisy scratching or slapping at insects would reveal their position to the enemy. However, the use of local anesthetic ointments should not be substituted for the proper use of insect repellents.

7-6. Allergic and Anaphylactic Reactions

Some individuals are highly sensitive to certain substances when eaten, breathed, or injected into the body. These individuals have an allergic reaction of variable degree when they take in a substance to which they are allergic. These reactions, affecting the entire body, may occur anywhere.

a. Urticaria. The common term for urticaria is "hives." This type of less severe systemic allergic reaction involves primarily the skin. Raised areas that itch appear in the skin all over the body. In some areas these are large and even connected to each other, causing generalized swelling of those areas. This is called "angioneurotic edema" and occurs usually in the face. Although the patient with urticaria is uncomfortable, the problem is not usually life-threatening unless anaphylaxis develops (para 11-13a). Angioneurotic edema may involve the tongue and, in that way, it could produce suffocation.

(1) Determination of the substance which provoked the urticaria may be difficult or impossible. If it is identifiable, the individual should avoid it in the future.

(2) Treatment involves administration of an antihistamine such as Benadryl. In more severe urticaria, 50 mg. of Benadryl should be given intramuscularly (I.M.). The reaction may take from hours to one or two days to subside, and evacuation may be necessary.

(3) It is critically important to observe patients with urticaria for development of anaphylaxis, which is often fatal.

b. Anaphylactic Reaction. This is the most severe allergic reaction. It produces intense bronchial edema. Breathing may be difficult or impossible. In addition, the circulatory system breaks down due to dilation of the arteries and leaking of the capillaries. Blood pressure falls. Death may result if proper treatment is not given immediately. Antibiotics are the group of drugs which most commonly produce anaphylactic reaction. Yet these reactions can result from drugs as common as aspirin, food allergies, and insect bites. Any time you are to administer a drug to a patient, especially by injection, you should first question him as to allergy

and then observe him at least 15 minutes for possible development of anaphylaxis.

(1) Although urticaria is usually present, the findings to look for are breathing difficulty (wheezing) and circulatory collapse (pulse, blood pressure, state of consciousness). The wheezing may be the limit of the reaction, but the patient must be observed closely until the wheezing disappears. If it worsens, if the patient is having great difficulty in breathing, if he becomes stuporous or comatose, or if his blood pressure drops (weak, thready pulse), immediate therapeutic steps must be taken.

(2) Apply a tourniquet above the injection site or the insect bite. This will help slow or prevent further allergen from getting into the circulation.

(3) Keep the patient breathing by maintaining an airway and using positive pressure artificial respiration if necessary. An emergency surgical airway probably is not indicated because the obstruction involves the smaller bronchi. Epinephrine should relieve the obstruction. An artificial oral airway may be helpful if the tongue is swollen.

(4) Start an I.V., using saline-type infusion to help maintain blood pressure and to provide a rapid route for infusion of drugs. Be prepared to start closed chest cardiac massage if cardiac arrest occurs.

(5) Urgent evacuation must be obtained, and the patient should be accompanied by someone trained in artificial respiration.

SEASONAL HAZARDS—HOT AND COLD INJURIES

8-1. Heat Injuries

Heat injuries are grouped as heat cramps, heat exhaustion, and heat stroke.

8-2. Heat Cramps

Heat cramps are due primarily to loss of salt from the body. Excessive sweating without replenishing salt will deplete body salts. A soldier with heat cramps complains of painful cramps in muscles of his legs and abdomen. Determine the amount of water intake and the amount of sweating. If his water intake is low and sweating is excessive, you can assume he has heat cramps. If you diagnose heat cramps, dissolve two crushed salt tablets in one canteen of water. Let the patient drink as much of this solution as he wants. In 15 to 30 minutes, he should be well if heat cramps are the problem.

8-3. Heat Exhaustion

Heat exhaustion is more serious than heat cramps. Caused by an excessive loss of water and salts from the body, heat exhaustion is a condition, preceding circulatory failure, in which there is not enough fluid to fill the vascular system and tissue spaces. The patient complains of dizziness, headache, weakness, nausea, vomiting, and cramping in muscles of his legs and abdomen. He usually has hot, moist, and pale skin. If not treated rapidly, heat exhaustion may lead to shock (circulatory failure). Once you have recognized heat exhaustion, treat it as follows.

- a. Give fluids orally with salt, but do not induce vomiting.
- b. In severe case of heat exhaustion, if the patient is nauseated or vomiting, start intravenous infusions of Ringer's lactate solution or saline if available as soon as possible.
- c. If vomiting and nausea are present, you may give compazine as directed by a medical officer. (You must have the permission and advice of your medical commander to carry compazine and to dispense it.)
- d. If the patient is not stabilized, he should be evacuated as a

priority. If stabilized, he may be evacuated as a routine or given light duty.

e. The best treatment is prevention. As soon as you see a soldier staggering, weak, or sweating excessively, ask him about his intake of water and output of urine. Lack of urine output is a danger signal. You must either notify the immediate commander (so that a rest period can be arranged) or plan on evacuating the patient. Give oral fluids and salt as the patient can tolerate them. (When operating in a hot environment, you should carry salt tablets and an extra canteen of water.)

8-4. Heat Stroke

Heat stroke is a malfunction of the body's heat regulating center in the brain. It is entirely different from heat cramps or heat exhaustion. Because of the patient's exposure to high temperatures, especially if he has been without a head cover, his central nervous system becomes incapable of controlling body temperature. The rectal temperature will be elevated to 106° F. or higher. Other signs and symptoms include headache, dizziness, loss of consciousness, and dry, hot skin. The patient may die quickly unless you take positive measures immediately. His body must be cooled rapidly. You can do this by immersing him in a stream or a canal or by pouring water over him and fanning him. The object of treatment is to reduce the body's temperature to about 101° F. as quickly as possible. The ideal method is to immerse the patient in an ice bath. Since you cannot do that in the field, you should duplicate it as closely as you can. All heat stroke patients should be evacuated as "urgents."

8-5. Cold Injuries

The serious cold injuries include trench foot and frostbite. Prolonged exposure to extreme cold produces severe injuries. Patients with relatively minor injuries must be reevaluated if prolonged environmental exposure to cold is a problem. Patients designated for routine evacuation should be given a higher category after prolonged exposure.

8-6. Trench Foot

Trench foot is caused by prolonged exposure to cold and wetness and by diminished circulation. Trench foot is worsened by keeping the feet still, or by wearing tight-fitting boots. Symptoms include uncomfortable numbness of the feet, clumsiness in walking, tingling and aching, cramping pain, and swelling of the feet. The treatment is to warm the affected parts in warm water or next to a warm body. Remove wet or constricting socks and boots. Do not massage or rub the affected parts; massaging frozen parts

breaks down tissue and aggravates the injury. Cover blisters and frozen areas with a dry sterile dressing applied loosely. Trench foot is prevented by maintaining circulation in the feet. This is done by avoiding prolonged inactivity of the feet and wearing loose-fitting dry socks and boots. If a soldier must stand in one place a long time, force him to exercise his feet to stimulate circulation.

8-7. Frostbite

Frostbite is the freezing of tissue in a localized area. It is caused by a lack of circulation of blood in the frozen area. Constriction of vessels by extreme cold prevents circulation of blood in the involved area. The result is tissue anoxia and death of the tissue. Symptoms of frostbite include an uncomfortable coldness in the affected area, followed by numbness. The skin at first is red, then pale or waxy white. The injured part has no feeling while it is frozen. In severe frostbite, edema and hemorrhage may occur when the part is thawed. First, you should remove all wet or tight clothing from the frostbitten area. Warm the area. The best method of warming is to place the involved area in a water bath at 104° F. If this is not available, the involved area can be warmed by placing it against the skin of some other area of his body or someone else's body. The patient should not be allowed to smoke, because nicotine in tobacco may further constrict blood vessels. Cover the frostbitten area with a loose, dry dressing. Do not try to force circulation to return to the frostbitten part by rubbing it. Treat the man as a litter patient if his feet are involved. To minimize cold weather injuries, rotation of troops is advisable during periods of exposure. They should practice the buddy system of inspecting one another for early detection of frostbite. Troops exposed to extreme cold for a very long time become numb and drowsy, with slowing of reaction time and impaired vision. You should remain alert to these possibilities and be ready to advise the commander on the proper use or the evacuation of patients with cold injuries.

8-8. Immersion

Prolonged immersion of a part of the body in water for hours, even in semitropical and tropical areas, can cause immersion injury (para 11-11). A form of immersion foot also results from immersion of the feet in cool or cold water. The colder the water is, the more rapidly injury occurs. The treatment is to rewarm the patient's feet to normal temperature. Then, if the tissues have been damaged, as in frostbite, the treatment would be similar to that for frostbite.

DRUG ABUSE AND EMOTIONAL PROBLEMS

Section I. DRUG ABUSE

9-1. General

The term "drug abuse" means illicit use of drugs, whether legal or not, to obtain certain nontherapeutic effects. In other words, the drug abuser takes the drug for reasons other than diagnosis, treatment, or prevention of disease. This section discusses briefly medical problems related to drug abuse.

9-2. Categories of Commonly Abused Drugs

Three categories of drugs are commonly abused. Their classification is based upon the effect of the drug on the central nervous system.

a. Depressants. Intemperate use of alcohol is the most common abuse of drugs in this category. Barbiturates and narcotics (such as heroin) also are primarily depressants. These drugs generally give the user a relaxed, tranquil sensation. Used in excess they can produce lethargy, coma, and even death. All are addicting.

b. Stimulants. These are primarily the amphetamine-type drugs. Their usage generally results in increased alertness and euphoria. Excessive use may produce psychotic reactions and death from high blood pressure. These drugs are addicting and they frequently lead to death if excessive use is continued over a period of months.

c. Hallucinogens. These drugs are difficult to classify either chemically or as to effect on the user. Marijuana, which can also be classed as a mild depressant, is the most commonly used hallucinogen, and its effects are generally the least noticeable. Other hallucinogens are LSD, STP, peyote, and mescaline. These drugs tend to produce various degrees of hallucination in the user. The result is a transient psychosis of "trip." Occasionally, the psychosis persists. Generally, these drugs are not known to be directly toxic except so far as the user may be led to behave in a hazardous manner.

9-3. Diagnosis and Treatment of Acute Drug Intoxication

Intoxication depends upon the type and amount of drug used.

a. Depressants. These drugs generally produce lethargy in the user. He may be sleepy, unresponsive, uncoordinated, breathing slowly, and slurring his speech. The narcotics (such as heroin, morphine, cocaine, meperidine, and codeine) often produce constricted or "pinpoint" pupils; alcohol and barbiturates have no effect on the pupils. Alcohol produces a characteristic odor on the breath. Recent needle marks on the body suggest drug injection. Treatment of acute intoxication with depressants is primarily supportive. The usual cause of death among users is respiratory failure. Consequently, you may need to perform artificial respiration (para 3-9) until the patient can breathe on his own. Even if he is breathing when you first see him, be sure he is kept under observation in case the effects of the drug deepen. Induction of vomiting may be helpful if the drug was taken orally in the immediate past. Administration of a stimulant such as coffee may be useful; but more powerful stimulants should be given only by a medical officer.

b. Stimulants. Physical evidence of amphetamine intoxication includes hyperactivity, manic or psychotic behavior, agitation, rapid speech, rapid heart rate, high or low blood pressure, dilated pupils, confusion, restlessness, panic states, and convulsions and coma. Treatment is largely symptomatic and may include induction of vomiting and sedation. However, you should not sedate the patient. Rather, evacuate him as soon as possible.

c. Hallucinogens. As with the other types of drugs it is difficult to list diagnostic physical findings which will tell you the patient is under the influence of a hallucinogen. The physical findings, in fact, may be virtually nothing. Your only clue may be the mental state of the patient. Both depressed and stimulant types of behavior may result. In other words, the patient may be depressed and unresponsive or panicky and hyperactive. He may be completely out of touch with reality. Your best help may come from the patient's story or from the history given by his friends. Treatment is generally supportive, although with severe reactions certain tranquilizers (such as chlorpromazine) may be used. This treatment should be performed by a medical officer.

9-4. Chronic Drug Abuse

It is not the purpose of this manual to philosophize or to moralize about drug abuse. Aside from providing emergency care for the acutely intoxicated drug abuser, there is little you can do to curb chronic drug abuse. Perhaps the most important responsibility you have is to educate the troops about the dangers of drug abuse, especially in combat situations. You should also be able to

advise the commander about the capabilities and limitations of drug users in the field. The Army is developing extensive programs for rehabilitation of chronic drug abusers. Your responsibility is to refer men who come to you for help to the appropriate facility.

Section II. COMBAT EXHAUSTION

9-5. Definition

Combat exhaustion is a transient emotional reaction or disturbance resulting from the psychological and physical stress of battle which is severe enough to make a soldier ineffective in combat. The term "combat exhaustion" is used because it suggests a temporary condition, originating in combat, that may be overcome rapidly. Combat exhaustion differs from normal battle reactions. Normal reactions may appear as increased muscular tension, shaking or tremor, sweating, loss of appetite, and rapid heart beat. Combat exhaustion is a harmful extension of these signs and symptoms. As fatigue, hunger, and fear of battle continue, worry and uneasiness increase. When a soldier cannot cope with these feelings, he develops combat exhaustion.

9-6. Factors Influencing Combat Exhaustion

Various stresses in combat contribute to combat exhaustion. One is the constant presence of danger. Another is frustration and boredom caused by long periods of waiting. Loss of sleep is a factor. So is the rarity of hot meals. Sore feet, minor wounds, and skin diseases also contribute to combat exhaustion. Inadequate orientation of newly arrived troops is another factor. Soldiers may also be upset by propaganda or bad news from home. They may consider the systems of reward and punishment unfair, or be disillusioned with the cause for which they are fighting.

9-7. Signs and Symptoms of Combat Exhaustion

- a. Increased pulse rate.
- b. Increased muscular tension.
- c. Stomach cramps, vomiting, and diarrhea.
- d. Abnormal respiration.
- e. Heightened reaction to noise.
- f. Increased alertness causing sleeplessness.
- g. Anticipation of disaster.
- h. Hypochondriasis (feigned illness).
- i. Extreme changes in mood, ranging from crying and complete breakdown to apathy or complete indifference.

9-8. Prevention of Combat Exhaustion

It takes the combined efforts of the commander, yourself, and your fellow troopers to prevent combat exhaustion. You have the most important part in this. If you are alert, you can detect early

signs of combat exhaustion. That is when you can do the most good for the potential patient. When a soldier complains of vague symptoms, looks nervous, and makes rash statements, you should become suspicious. If these symptoms get worse, you should talk privately with the soldier's platoon sergeant or immediate supervisor. This working relationship between you and the leaders can prevent most cases of combat exhaustion. Leaders should know about the disturbed individual so that he is not assigned to a sensitive task.

9-9. Disposition of Patients

Patients with combat exhaustion should be treated early while they are in their platoon or element. You should enlist the aid of the patient's leaders and buddies in initial treatment. The following are some of the things you can do.

a. Give additional consideration to the patient's wounds or infections. Change the dressings and apply medications. Emphasize reassurance. Show interest in the man and see that he gets rest.

b. Request his immediate commander to give him some words of praise and assurance. Assure the patient that he is needed and appreciated.

c. Do not permit anyone to scold or ridicule the patient. Slapping or otherwise abusing a patient to "bring him out of it" is wrong. The patient would not behave in this manner if he could help himself.

d. Request one of the commanders to reorient the patient as to the mission and his importance to it.

e. If the patient has problems at home, reassure him that you will go with him later to the proper authorities to try to resolve them. Then, do it.

f. Encourage some of his buddies to talk to him and promise to cover him if they are attacked.

g. Do not evacuate the patient unless it is entirely necessary. If it is to the advantage of the patient and the element to evacuate him, do so by resupply vehicle rather than medical evacuation. The patient should not get the impression that he has a serious mental illness or is mentally incapacitated. Irreversible damage can be done to a patient if he is labeled a "psycho." Unless the patient has a complete breakdown, evacuate him to company headquarters for rest and assistance. Evacuate him to a medical facility only when that is entirely necessary.

COMMON DRUGS AND THEIR USAGE

18-1. Medications Carried By the Aidman

The medications you use in the field should be based upon your knowledge and skill, the amount of weight you can carry on a mission, and the evacuation lag time. Of these, knowledge and skill are most important. The mission usually dictates how much and what kinds of drugs you carry. As an example, the average aidman on an ordinary 3-day mission may carry the following items:

a. ASA (Aspirin). Aspirin is the best drug you will carry. It is useful for fever and as an anti-inflammatory drug. It can be given to patients with painful minor injuries, bruises, and fever. The adult dose is two tablets every 4 hours. Carry about 50 tablets and try to keep them fresh.

b. Antihistamines. These are used as nasal and sinus decongestants in cold and allergies. A number of antihistamines are available. The one used most is Benadryl. (One tablet every 6 hours is usually given.) Carry about 24 capsules. Since antihistamines produce drowsiness, they should be used with extreme caution in individuals who must remain alert.

c. Anesthetic Ointment. This deadens the itching of insect bites and other skin rashes. Tetracaine, dibucaine, nupercaine, and other "caine" ointments are equally effective. Tetracaine is used most. Two tubes are enough to carry.

d. Antimalaria Tablets. In malaria-infested areas, soldiers generally take these tablets daily or weekly, depending on the type. Carry enough to supply the men for the duration of the mission.

e. Cough Medication. A coughing soldier may give away a position, so carry some cough lozenges. They are convenient to carry and easy to administer.

f. Indigestion Medication. Antacid tablets are commonly packaged in waterproof plastic. One or two tablets may be chewed or dissolved in water to relieve indigestion.

g. Salt Tablets. When operating in hot weather, many aidmen carry salt tablets. When troops are sweating a lot, losing body water and salt, they are subject to heat exhaustion. One or two salt tablets dissolved in a canteen of water will help prevent heat

exhaustion. A pint of this solution every half hour may be needed under strenuous conditions in a very hot climate.

h. Tablets for Nausea and Vomiting. Nausea frequently accompanies many minor viral infections. It is also a sign of heat exhaustion. For nausea, an antiemetic such as Compazine or Tigan may be given. Because of undesirable side effects which may occur, discuss the use of these drugs with a medical officer before taking them with you.

i. Morphine. Morphine is the best drug for severe pain such as that produced by most battle injuries. It should never be given to any patient with a head injury, breathing difficulty, unconsciousness, or abdominal pain of uncertain cause. Because it is a narcotic, a medical officer will determine how much morphine you will carry and the dose to give.

j. Water Purification Tablets. It is the individual soldier's responsibility to carry water purification tablets. For those who fail to do so, you should carry an extra bottle of the tablets.

k. Anti-diarrheal Drugs. Kaopectate-type liquids are the most readily available (in powdered form). Carrying one bottle of this may be very helpful. The dose is three or four capfuls every 2 to 3 hours until the diarrhea subsides.

18-2. Misuse of Antibiotics

The use of certain drugs, notably antibiotics, in the field is contraindicated. Antibiotics are the drugs most often misused by aidmen. Many times, it may do more harm than good to give antibiotics in the field. Adverse conditions likely to develop from field use of antibiotics include the following:

a. Serious drug reactions may occur which you cannot handle, especially when penicillin is administered.

b. Inadequate dosage may make organisms resistant to an antibiotic and seriously hamper further treatment with it.

c. Giving the wrong antibiotic or an inadequate dose may mask the causative organism and make it difficult, or impossible, for the laboratory to identify it.

d. Giving the wrong antibiotic or an inadequate dose may also mask the signs and symptoms of the disease, making diagnosis difficult for the medical officer.

NONTRAUMATIC DISEASE

10-1. Introduction

Traumatic injuries, such as those produced by bullets and grenade fragments, are relatively easy to diagnose. The problem is usually easy to see. Diseases caused by bacteria or other infectious organisms are much harder to diagnose. Following certain procedures, however, will aid you greatly in discovering and treating the problem. This chapter outlines general principles in approaching non-traumatic, or medical diseases. The remaining chapters in this manual deal with specific medical diseases of each system of organs.

10-2. Examination

a. You can find out much about a patient by using your sight and touch and by asking questions. The appearance of a soldier when you first see him tells much about his condition. You can see if he has trouble breathing. You can see if the color of his lips, face, or fingernails is abnormal. Looking at him, you can tell if he is having a chill. A rash on his skin will be evident to you, too. Touching his skin, you can tell if it is wet or dry, cool or hot. You can ask him what his complaint is, and whether he has had it before. Does he have a headache? Diarrhea? Pains? What kind of medicine has he taken lately?

b. The examination you make differs from the medical officer's mainly in degree of sophistication. Your equipment and assistance are limited. The medical officer in the hospital can request X-rays and laboratory tests of the patient to aid his examination. After making the diagnosis, the medical officer either treats the patient or evacuates him—which are the same actions you take in the field.

10-3. Routine Tests

Sometimes, you need to tell a patient exactly what laboratory test or other diagnostic procedure may be done on him. For instance, to a patient with a fragment wound, you might explain that X-rays will probably be ordered by a physician to determine whether or not a fragment is imbedded in his leg or arm. A simple explanation

of tests and examinations such as the following may help to relieve a patient's apprehension.

a. Blood is taken for cell counts, studies of blood chemistry, crossmatching before transfusions, studies for malaria parasites, and other tests.

b. Urine is collected to detect acidity or alkalinity and the presence of blood cells, sugar, protein, and certain minerals.

c. Samples of feces are studied for evidence of blood, bacteria, amoeba, worms, mucus, and pus.

10-4. Instruments for Examinations

There are many special instruments to aid medical personnel in examining patients. However, you will have few or none of these when you go into the field. You do not need them. A rapid, thorough examination using your own senses is all you need to arrive at the key decision you must make—whether or not to evacuate the patient. Instruments used by medical personnel in the rear, such as thermometers, stethoscopes, otoscopes, ophthalmoscopes, and sphygmomanometers, often do little except put numbers on a medic's findings.

10-5. Principles of Treatment

In treating a patient, you try to do three things: arrest, stabilize, and return to normal.

a. Arrest means to remove the cause from the patient or remove the patient from the cause. If a soldier's clothing is burning, either put out the fire or tear off the burning clothing. If a soldier is in a toxic chemical environment, either remove him from the environment or put the protective mask on him. If a soldier is suffering from heat stroke or heat exhaustion, remove him from the heat and begin to stabilize him. If a soldier has an acute disease with high fever, reduce the fever and continue the treatment.

b. Stabilize means to get the patient into the best possible condition for evacuation or treatment. This could mean doing any of a variety of things. It may mean reducing a high fever, starting intravenous medication, giving oxygen, getting the patient into a better environment, or putting him in a comfortable position.

c. Return to normal is the ultimate goal of medical treatment. This is done by removing the cause of the abnormal condition and helping the body to repair damaged cells, tissues, and organs.

10-6. Fever

Most complaints which bring patients to you will be localized; that is, they will indicate a problem in some specific area of the body. Back pain, headache, cough, pain on urination, and diarrhea are examples of localized complaints. However, one very important

symptom or sign is fever, which is not localizing. Knowledge of the presence of fever is useful to you, because it establishes firmly the presence of disease. It may be the only way you can determine that a patient with vague complaints is really sick.

a. Be sure that fever really exists. Do not take the patient's temperature immediately after he drinks a hot or cold liquid. If he claims to develop fever only at night, invite him to visit you when he has the fever.

b. Fever indicates inflammation (usually infection) somewhere in the body. The most dangerous possibility is meningitis (para 17-8a); you should always check the patient with fever for a stiff neck. Careful questioning about the major body systems will often reveal the general area of the inflammation (respiratory, gastrointestinal, or genitourinary).

c. Fever itself can be dangerous if it is excessively high (105° F. or higher). In this case you must reduce the body temperature as rapidly as possible. Administer oral aspirin (two tablets) and give the patient alcohol baths, ice water baths, or anything which might cool him. Encourage him to drink fluids since fever also tends to dehydrate the body. Intravenous fluids may be necessary in very sick patients.

d. Lower temperature fevers may be treated with two aspirin tablets every 4 hours. First establish and record the presence of fever in the patient. If he is to be evacuated, note clearly on the records that aspirin has been given and when it was given.

e. Patients with fever must not perform duties. They must rest. Refer them to a medical officer. If the temperature is 105° F. or higher, request urgent evacuation.

10-7. Immunization

Many diseases are easy to prevent but hard to treat. Tetanus and rabies can be prevented by immunization, but once their symptoms appear they are usually fatal. Cholera can usually be prevented with proper immunization. Immunizations prescribed by the Army are effective in preventing many diseases. Every soldier is responsible for receiving all immunizations for his assigned area which are available to him and keeping them current. It is your responsibility to advise the soldier and help him in getting the required immunizations. The immunizations normally given to military personnel are for smallpox, cholera, yellow fever, tetanus, typhoid, poliomyelitis, influenza, diphtheria, and plague.

DISEASES OF THE SKIN

11-1. The Skin

The skin is a tough, elastic structure covering the entire body. It has two principal layers, the epidermis or outer layer, and the dermis or inner layer. The epidermis has a superficial layer and inner layer. The superficial or horny layer consists of dead cells which are constantly being worn off. These are replaced from the living cells which form the inner layer. The dermis is the thicker part of the skin. It consists of connective tissue containing blood vessels, nerve endings, sweat glands, sebaceous glands, and hair follicles.

11-2. Functions of the Skin

The skin is the largest organ of the body. It performs the following functions:

a. Protection. The skin protects underlying structures by acting as a mechanical barrier. When the skin is broken, microorganisms may invade the body through the opening.

b. Regulation of Body Temperature. The skin regulates body temperature by controlling heat loss in two ways.

(1) Blood vessels in the skin change in size. They dilate and bring warm blood to the surface to increase heat loss. They constrict to decrease heat loss.

(2) The skin produces sweat which, when it evaporates, cools the surface of the body.

c. Sensory Perception. The skin acts as an organ of perception. It contains sensory nerve endings specialized to detect heat, cold, pressure, touch, and pain.

d. Secretion. Sweat is salt water which cools the body by evaporation on the skin. It is secreted by the sweat glands which open by ducts onto the surface of the skin. The ducts or openings are called pores. Sweat glands are distributed in large numbers over the body. They secrete an average of 1 quart of sweat a day. The amount of sweat varies considerably, depending upon the atmospheric temperature and humidity and the amount of exercise performed by the individual. Sweating is continuous, but it may be

so slow and the sweat may evaporate so quickly that it is imperceptible. Sweat consists chiefly of water (99 percent), with small quantities of salts and organic waste products. The skin also secretes a thick, oily substance called sebum, which is produced by the sebaceous glands. Sebum lubricates the skin and keeps it soft and pliable.

e. Absorption. Although absorption is not one of its normal functions, the skin can absorb water and other substances. Some drugs may be taken into the body by absorption. Certain nerve agents, for example, are absorbed rapidly through the skin.

11-3. Terms Used for Abnormal Skin Conditions

- a. Bulla.* Large blisters filled with serous fluid.
- b. Cellulitis.* Infection involving all layers of the skin and inflammation of the loose cellular tissue that lies under the skin.
- c. Dermatitis.* Inflammation of the skin.
- d. Edema.* Excessive collection of watery fluid in tissue.
- e. Erythema.* Redness of the skin.
- f. Folliculitis.* Infection of hair follicle(s).
- g. Furuncle.* A boil.
- h. Impetigo.* Bacterial infection limited to the epidermis.
- i. Induration.* Hardness.
- j. Lesion.* Any localized abnormality.
- k. Pustule.* Vesicle containing pus.
- l. Pruritis.* Itching.
- m. Rash.* A temporary eruption on the skin.
- n. Ulceration.* Open sores on the skin.
- o. Vesicle.* Small blister.

11-4. Elements Hostile to the Skin

Since the skin is large and constantly exposed to man's environment, it is certain to be one of your biggest medical problems. Weather, insects, disease germs, and trauma are some of the hostile environmental elements which frequently attack the skin. This chapter discusses primarily infections and allergies of the skin. Heat and cold injuries are covered in chapter 8, trauma and burns in chapters 4 and 5.

11-5. Viral Infections of the Skin

a. Verruca Vulgaris. This is the common wart. There is no effective medication for the removal of warts. They can be removed by cautery, freezing, or surgery. No way is known to prevent warts.

b. Herpes Simplex. This infection is called a fever blister or cold sore. It usually occurs on the lips, but it may appear on other parts of the body. It occurs as a small, painful vesicle (blister),

either singular or in clusters. No medication cures or dries up herpes simplex. Treatment is symptomatic (directed toward relieving the discomfort). No way is known to prevent herpes simplex, but the patient can keep it from spreading if he does not scratch it. Never put cortisone-type cream or ointment on these lesions.

c. Herpes Zoster. This is the painful viral infection commonly known as "shingles." It appears as a large group of vesicles along a sensory nerve path. The lesions are very painful. They usually appear on the skin of the abdomen from under the ribs toward the navel. The area of the skin along the path of the vesicles is red and tender to the touch. There is no specific medication for shingles and no method of preventing it. Treatment is directed to relieving pain and discomfort. Never apply cortisone-type cream or ointment to these lesions, for that will only make them worse.

11-6. Bacterial Infections of the Skin

a. Bacteria are single cell forms of life, visible only under a microscope. Most are harmless to man. Some are even necessary to life, like those in the intestines which make vitamins K and B12. Bacteria are always on the skin. It is not possible by any safe method to kill all of them. Many bacteria live on the surface of the epidermis, and most are harmless. The largest numbers of bacteria live in the hairy openings of the skin. Washing with soap and water removes some bacteria. This may be worthwhile if it is not done so often or so roughly that it damages the skin barrier. Pure alcohol kills some bacteria. Most effective is a mixture of 70 percent alcohol and 30 percent water, which is used to sterilize the skin before injections. Iodine solutions are also used to kill bacteria, but care must be taken to avoid iodine burns of the skin. Burns may be prevented by wiping off excess iodine with 70 percent alcohol.

b. Bacteria on the skin need moisture to grow and multiply. In hot, humid weather, bacterial skin infections are common because skin bacteria multiply greatly under hot, moist conditions. The moisture of a cut or scratch also helps the growth of bacteria.

c. The bacteria that cause the most skin infections are staphylococcus aureus, commonly called "staph," and Beta hemolytic streptococcus, commonly called "strep."

11-7. Types of Bacterial Infections of the Skin

a. Impetigo. Impetigo is a bacterial infection limited to the epidermis. It is caused by staph or strep, but often by a combination of both. It begins suddenly, usually on the face, arms, or legs. One or a dozen lesions may be present. Bacteria can lodge on clothing or under fingernails and be spread to other parts of the

body or to other persons. Impetigo is mildly tender to the touch, and it itches or burns slightly. The skin surrounding the lesions appears normal at first, but a ring of redness develops in a day or two. Impetigo may develop in a few hours as a vesicle, a pustule, a bulla up to 3 inches in size, a raw glistening spot, or a crack in the skin. Within a day or so, a soft, soggy, yellow or colorless crust forms that is fairly easy to remove. An infected fever blister, infected hangnail, infected insect bite, cut, or burn at the same site or elsewhere on the body may be the source of bacterial infection. Often there is no preceding skin infection. Since it is superficial, impetigo heals without scarring, but it may leave a red or brown mark which disappears in 2 weeks.

b. Ecthyma. Ecthyma is similar to impetigo except that it goes into the dermis and heals with a scar. Ecthyma has a tough, hard, brown or black crust that is difficult to remove. When the crust is removed, the raw base may bleed. This crust can form again in a few hours. Squeezing or pressing on an ecthyma causes great pain. The raw base leaves an ulcer which is very painful to the touch. Ecthyma may be either a staphylococcal or streptococcal infection.

c. Folliculitis. Folliculitis is an infection of a hair follicle. It is small and slightly tender and contains pus. Although usually due to bacteria, it can be caused by fungi or chemical.

d. Furuncle. Furuncle, or boil, is a staphylococcal infection of a hair follicle and tissue around it. There is redness and pain. At first, there may be only a red lump, but in a few days a yellow "head" develops on the surface. When a furuncle opens, pus, blood and a plug of dead tissue (core) comes out. If the furuncle is small, it heals without a visible scar.

e. Cellulitis. Cellulitis is a diffuse staphylococcal or streptococcal infection of cellular or connective tissue spreading widely through all layers of the skin. It can be a complication of a localized infection, such as a furuncle, or it can occur alone.

f. Lymphangitis. Lymphangitis is an infection with red streaks in the skin going up the lymph vessels of the leg or the arm from ecthyma, cellulitis, or any infected skin lesion. Lymphangitis generally is caused by a streptococcal infection. Chills and fever often occur with it. Regional lymph nodes in the armpit or the groin draining the affected extremity may be swollen and tender.

11-B. Treatment of Bacterial Infections of the Skin

a. The most important procedure in the treatment of localized skin infections is to keep them clean. Gentle washing or soaking in warm water containing surgical soap several times a day is generally ideal. In impetigo and ecthyma the crust must come off. Soaking in warm water should loosen the crust for removal. Pus accumulates under the crust and infection spreads under it. The

crust keeps the edges of the skin from growing together and healing. Usually there is bleeding when the crust of ecthyma is removed no matter how gently it is removed. For noncrusting localized skin infections, such as furuncles or folliculitis, cleansing and warm water soaks are effective. Do not squeeze a furuncle. Squeezing may cause cellulitis to develop. Antibiotic skin creams may be valuable in treating skin infections.

b. Systemic antibiotics are required treatment for nonlocalized skin infections and multiple localized infections. Examples of such infections are more than three lesions of impetigo, more than two ecthymas, and any lymphangitis, cellulitis, or folliculitis if it is sore and painful and several lesions are present. Refer these patients to a medical officer as soon as possible; you should never prescribe systemic antibiotics.

11-9. Fungal Infections of the Skin

a. Fungal infections of the skin are common. Fungi are tiny multicellular plants without roots, stems, leaves, or green pigment (chlorophyll). They feed on dead or living organic matter. Examples of fungi are mushrooms, bread molds, and leather mildew. Although many thousands of fungal species exist, only 20 species of fungi can live on the human skin and produce disease.

b. Fungi that attack the human skin use the dead outside layer for food. As they grow, they digest the dead layer and cause the skin to redden, blister, scale, and itch. They may grow out from the center to get more food, sometimes causing ring-shaped lesions commonly called "ringworm." Patches of blisters and dull, red scales between the toes, soles of the feet, and on top of the feet, ankles, groin, face, and scalp are usually caused by one class of fungi. Yeast (another class of fungi) infects the groin, armpits, anus, buttocks, and any moist, warm area where skin rubs against skin.

c. Fungal infections usually begin as small, red, scaling macules around the feet, ankles, groin, or buttocks. In a few days, they become papular, usually scaling on the advancing edge, and tiny vesicles appear. Mild at first, itching becomes worse as inflammation increases, often waking the patient. Itching of the groin is particularly severe at night. The center of the lesion is less red than the edges, producing the ringworm. The papules enlarge and grow together, forming large areas of dermatitis. The entire buttocks and legs may be involved. When the onset is acute and very rapid, groups of tiny vesicles or pustules are seen. The itching is usually severe. The patient scratches off the tops of the pustules. Then bacteria invade and cause a secondary infection. Crusts and cellulitis may result. On hairy areas, fungus may grow into the hair follicles, causing pustules, small boils, or folliculitis.

11-10. Treatment of Fungal Infections

Antifungal cream (fig 11-1) is used to treat all fungal infections because it is antifungal, antipruritic, anti-inflammatory, and antibacterial. If this cream is not available or the patient cannot tolerate it, you may use 1 percent tolnaftate (Tinactic) solution. Rub the cream gently into the infected areas until it disappears. If you can see the cream after rubbing, you are using too much. It is especially important to rub it in well in the groin and between the toes. After the infection has healed the cream should be used at least 1 week to prevent the infection from recurring.



Figure 11-1. Antifungal medication.

11-11. Skin Diseases Caused by Water Immersion

In hot countries, three types of disabling skin diseases are caused by prolonged wetness of the skin.

a. Type 1 is confined to the soles of the feet (fig 11-2) and is called "warm water immersion foot." This type of warm water damage to the skin occurs where there are many creeks, streams, canals, and swamps to cross with dry ground between them. After about 3 days, the thick outer layer of the skin on the soles of the feet becomes white and wrinkled. Some of the creases in the soles of the feet become very tender on walking. During the next 2 or 3 days, the pain becomes severe on walking and the feet swell slightly. When the boot is removed, it may be impossible for the soldier to put it on again because of the pain and swelling. The pain is greatest on the heels and balls of the feet. The soldier complains that it feels as if he is walking on pieces of rope in the boot. The only treatment is to put the man at rest with his boots and socks off, and to see that his skin is dried and stays dry. In a day or so the wrinkling, whiteness and soggy skin disappear. The pain leaves, although the soles of the feet remain tender on walking for a few days. In 3 to 6 days, the thick skin on the soles begins to peel.

b. Type 2 water immersion skin disease (fig. 11-3) is called "paddy foot." This condition involves the tops of the feet and legs. It is common where soldiers have to wade through the muddy rice paddies, swamps, creeks, streams, and canals. In that situation, the exposure to water is almost constant. Drying is prevented by men standing in water or mud or having a heavy coating of mud on their boots. This disease is most prevalent when the temperature of the water or mud remains about 85° F. or higher.

(1) It involves the tops of the feet, the ankles, and the legs up to the boot tops. In 2 or 3 days, the skin turns red, a cellulitis appears, and much swelling occurs. Because of the swelling, there is much pain and tenderness, and the skin is stretched and hard. As a result, it is easily bruised and scraped. Large deeper raw spots or abrasions of the skin may be caused by the rubbing of the boot against the soggy skin. The soles of the feet may not be involved, or they may have some conditions typical of warm water immersion foot.

(2) About one-half of the men will develop tender, swollen lymph nodes in the groin. Mild to moderate fever (100° to 102° F.) may be present.

(3) These patients are treated by getting them to a dry area, removing their boots and socks, and putting them at rest with the feet elevated. It is better not to let them sit, but to insist on them lying down. Within 6 hours the edema becomes soft and pitting, that is, dents show after finger pressure. Pain, swelling, vesicles,

(1) The main symptom is itching. Consequently, fingernail scratch marks are seen on the skin. The tiny, dark lice are visible and move violently when pulled off the hair or the skin. They can be seen and identified better with a magnifying glass.

(2) Treat the infestation with 2 percent diazinon powder with lindane powder. Thorough application is important. Let the medication stay on at least 24 hours. Repeat the application after 1 week and again after 2 weeks.

(3) Infestation by lice is prevented by bathing and dusting with pesticide powder (diazinon or lindane) after exposure. Contaminated clothing and bedding also should be dusted thoroughly with a pesticide.

b. Body Louse. The body louse (pediculus) lives and lays eggs on the seams of a person's clothing and feeds on his skin. It lives on human blood and dies in a short time if denied food. The body

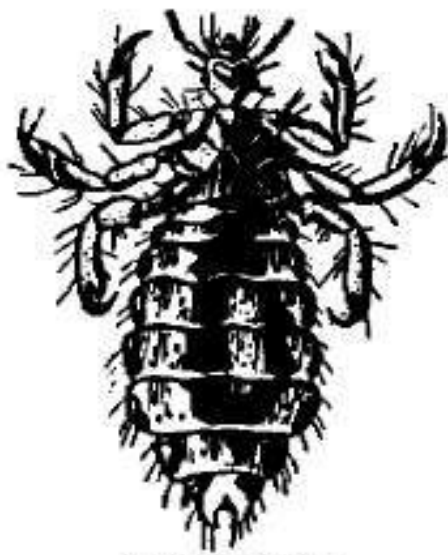

HEAD LOUSE

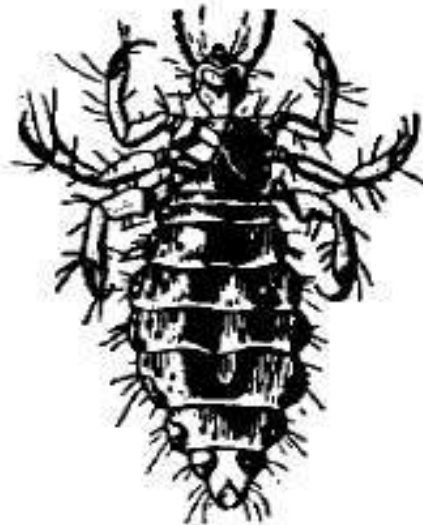

BODY LOUSE

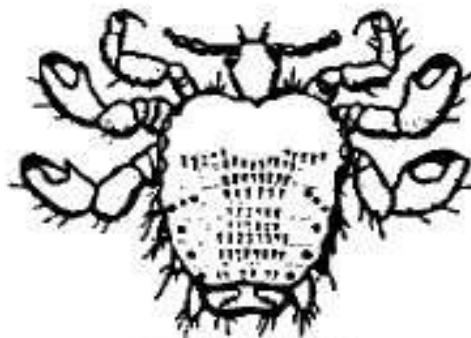

CRAB LOUSE

Figure 11-4. Lice.

louse has military importance because it transmits typhus and relapsing fever.

(1) The adult body louse has six legs. The female louse attaches its eggs to fibers of clothing, usually along seams. The eggs are white, oval-shaped, and about the size of the period at the end of this sentence.

(2) Treat the infestation with pesticide powder the same as for the crab louse (*a* above). In addition, dust the patient's clothing thoroughly especially along the seams.

c. Head Louse. The head louse is similar to the body and crab louse in its habits. It carries no known disease but, because of scratching, it is the indirect cause of secondary infections. Treatment for head louse infestation is the same as for crab or body lice.

11-13. Allergic Conditions

In allergic conditions, the soldier is sensitive to some foreign substances which may contact his skin or be introduced into his body in the food he eats or the air he breathes. A first contact is necessary to produce the sensitization. After that the soldier reacts abnormally to contact with the substance. Some substances can provoke an allergic reaction in anyone contacting them. Others cause an allergic reaction only in persons with a constitutional or inherited predisposition to allergy.

a. Urticaria, or hives, is an allergic reaction to substances which are injected, breathed in, or eaten. Drug allergy is an example of hives. It appears as rounded or irregularly shaped, transitory elevations of the skin. In severe cases, it may appear as general swelling of the face, hands, and other parts of the body. Urticaria is usually associated with much itching and may cover the whole body. Often, its cause is hard to determine, and the reaction may recur. Treatment consists primarily of identifying and avoiding the substance causing the reaction. Other treatments include the use of antihistamine drugs, such as Benadryl, and calamine lotion.

b. Contact dermatitis is an allergic condition due to sensitization of the skin by direct contact with a sensitizing substance. The skin turns red in the contacted area, itches, and small blisters may appear. The affected area may become scaly or may have the appearance of a rash. The blisters may become secondarily infected by bacteria. The reaction appears only in skin which comes in direct contact with the sensitizing substance, although the patient may carry it to other areas of the skin with his hands. The sensitizing substance may be almost anything, such as poison ivy, medicines, clothing, or soaps. Treatment includes removal of the allergen and use of antihistamines, bland lotions and creams, and cortisone creams.

11-14. Differential Diagnosis

Edema and swelling.....	Allergy, immersion diseases.
Itching	Fungal infections, allergies, or insect bites.
Pus	Bacterial infections, primary or secondary.
Rash	Allergy, infections such as measles or typhus.
Scaly	Allergies, fungal infections.
Ulceration	Viral and bacterial infections, paddy foot, chancre of syphilis.
Reddening of skin.....	Infections, water immersion, allergies.
Elevated temperature	Bacterial and viral infections, severe allergies.
Blisters	Viral infections, contact dermatitis.
Pain	Infections, allergies, immersion diseases, first and second degree burns.
Nits or eggs on hair shaft.....	Pediculosis (crabs).
Hives	Allergies.
Swollen face, eyes, or lips.....	Severe allergies, kidney disease.
Crusty surface	Bacterial and viral infections.
Chills	Bacterial infection.
Red streaks	Lymphangitis.
Swelling of feet.....	Immersion diseases, heart failure, or kidney disease.
Whiteness and wrinkling.....	Immersion diseases.

DISEASES OF THE MUSCULOSKELETAL SYSTEM

12-1. Musculoskeletal System

Diseases of the musculoskeletal system are the ones that cripple the most and kill the least. They cause much discomfort. They can lead to permanent deformity, but rarely are they fatal.

12-2. The Skeletal System

a. Skeleton. The skeleton, or bony framework (fig 12-1), in the adult is made up of about 200 bones. Bones are living tissue even though the spaces between bone cells consist of inorganic deposits of calcium. Each bone is a separate organ with its system of blood, lymphatic vessels, and nerves.

(1) The skeleton gives form and stability to the body, protects many organs, furnishes a system of levers which allow the body to move, and manufactures blood cells in the red bone marrow.

(2) The periosteum, a thin membrane, on the outside of each bone, is essential for the nourishment, growth, and repair of bone. The hard, dense, outer layer of bone, known as the compact bone, is thick along the shaft and thin at the ends. It gives bone its great strength.

(3) The inner spongy bone is made of the same material as compact bone but it is more porous. It makes the bone lighter without sacrificing strength. Bone marrow is found mostly in the shafts of long bones. Within bone marrow, fats are stored and new red blood cells are produced.

b. Joint. A joint is a structure which holds together separate bones and provides them a working surface which either permits or inhibits motion.

(1) Most joints of the human body are inside a fibrous joint capsule. Cartilage is found in the capsule at the tips of the ones which meet there. Cartilage acts as a cushion between the bones and helps to reduce friction in the joint. Lining the inside of this capsule is the synovial membrane (fig 12-2). Fluid secreted by the membrane aids in cushioning and lubricating the joint. On the outside of this capsule are tough connective tissues, known as

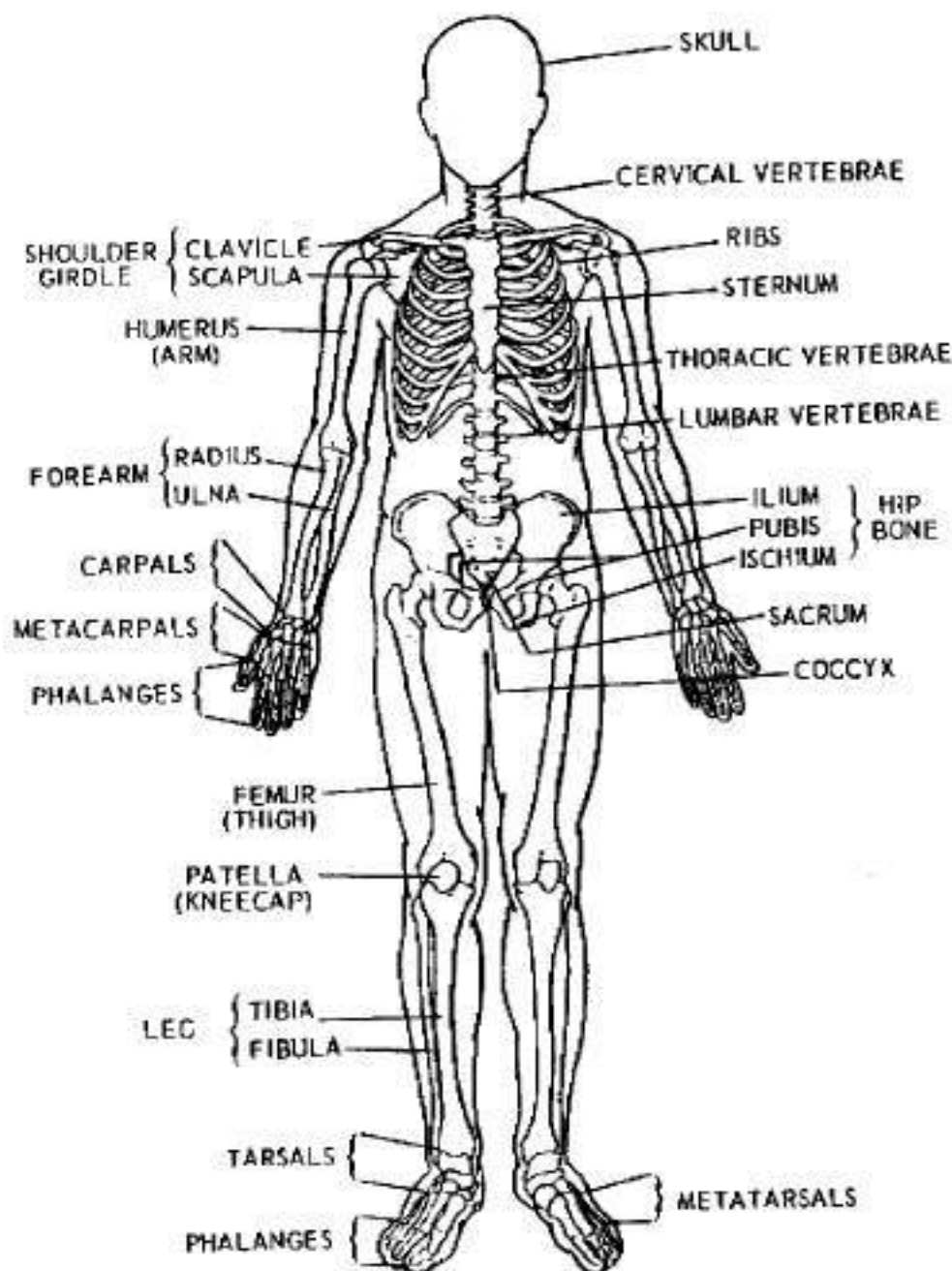

Figure 12-1. The human skeleton.

ligaments, which actively bind the bones together. Most joint injuries involve either the ligaments, synovial membrane, or cartilage.

(2) On the outside of the joint is a closed, slippery, fluid filled sac, called a bursa. Bursae are found between surfaces which glide over each other. For example, they may lie between the tendons and the surfaces on which they glide. (Tendons are connective tissue which join muscle to bones.) Like cartilage and synovial fluid, normal bursae reduce friction.

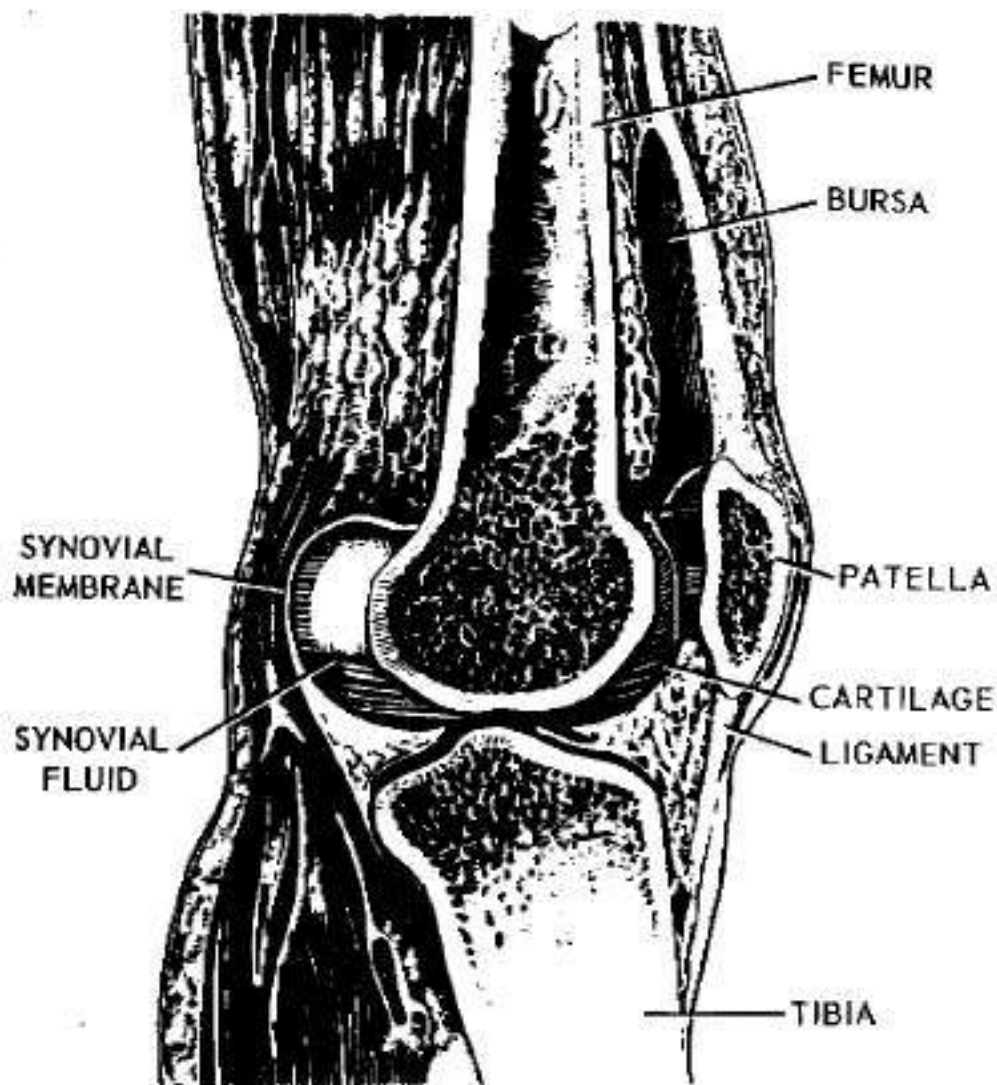

Figure 12-2. The knee joint and its parts.

12-3. Muscles

Muscles are organs of voluntary or involuntary action which provide motion by their ability to contract. Muscle tissue is found throughout the body and makes up 40 to 50 percent of the body's weight. According to their type of nervous control, muscles are classified as either voluntary or involuntary in action.

a. Voluntary muscle, or skeletal muscle, is called "voluntary" because it is under the direct conscious control of the brain. Most skeletal muscles are attached directly to the skeleton. By contraction, they move various parts of the body. Besides enabling the body to move, the skeletal muscles maintain posture, aid in respiration, and produce most of the body heat.

b. Involuntary, or smooth muscle, is not under the direct conscious control of the brain. Smooth muscles act more or less automatically. They are found in the walls of blood vessels, respiratory

passages, gastrointestinal tract, ureters and urinary bladder, and some glands. They regulate the size of blood vessels, move food through the gastrointestinal tract, regulate the air passages in the lungs, and aid in the transport of urine from the kidneys to the outside.

c. Cardiac (heart) muscle is unique. Physically it resembles skeletal muscle but its function is similar to that of smooth muscle.

12-4. Useful Terms

a. *Atrophy*. A wasting away resulting in a reduction in size.

b. *Ankylosis*. Stiff joint; abnormal immobility and consolidation of a joint.

c. *Articulation*. A joint; joining together of bones.

d. *Deltoid*. The triangular muscle over the shoulder joint, commonly called the "pin cushion of the Army," which raises and extends the arm.

e. *Inter*. A prefix meaning situated or occurring between; an example is intercostal, meaning between the ribs.

f. *Intercostal Muscles*. Muscles between the ribs which aid in respiration.

g. *Intervertebral Disk*. A layer of cartilage, shaped like a round plate, which acts as a cushion between adjacent vertebrae.

h. *Myo*. A prefix denoting relationship to muscle, as in myositis, inflammation of a voluntary muscle.

i. *Osteo*. A prefix denoting relationship to a bone or bones, as in osteomyelitis, inflammation of bone marrow and bone.

j. *Sign*. A measurable objective occurrence of the body, such as pulse, temperature, respiration, or blood pressure.

k. *Symptom*. A subjective complaint or feeling expressed by a patient and not measurable. Examples of symptoms are pain, dizziness, nausea, cyanosis, jaundice, and ache.

l. *Trauma*. A wound or injury.

12-5. Diseases of Joints

a. *Arthritis*. Arthritis means inflammation of joints. The inflammation may lead to deformity of the joint. Symptoms are pain, swelling, redness, and stiffness. Other symptoms and signs may include infections elsewhere in the body in the case of infectious arthritis and a low grade fever. After repeated episodes of inflammation, a joint may become permanently stiff with limitation in motion due to scarring of the joint surfaces.

(1) Infectious arthritis is produced by various bacteria including the staphylococcus, streptococcus, pneumococcus, gonococcus, and meningococcus. Usually the infecting organisms are carried to the joint in the blood from infection elsewhere in the body.

(2) Degenerative joint disease

b. Treatment in the field is limited to aspirin and heat. Evacuation. Arthritis may involve any portion of the vertebral column. Chronic low back pain may be due to poor posture or repeated trauma to the back. Signs and symptoms may be the same as for acute trauma or arthritis. Treatment in the field is limited to analgesics. You may suggest limitations in duty assignments.

12-8. Differential Diagnosis

Swelling of joints.....	Arthritis (all types), rheumatic fever, sprains.
Pain	Arthritis (all types), rheumatic fever, infections, inflammation.
Joint pain and stiffness, improves with activity.....	Rheumatoid arthritis.
Joint pain and stiffness, worsens with activity.....	Osteoarthritis and other types of arthritis except rheumatoid arthritis; sprain; fracture; gout.
Redness	Arthritis, bursitis.
Stiffness	Arthritis.
Elevated temperature	Rheumatic fever, all infections.
Infections elsewhere in the body	Meningitis, encephalitis, kidney, bladder, prostate.
Stiff neck, headache.....	Meningitis, encephalitis.
Back pain radiating down leg..	Slipped disc, kidney stone.
Deformity	Osteoarthritis, rheumatoid arthritis.
Is condition migratory?.....	Rheumatoid arthritis, rheumatic fever.
Pain on motion.....	Arthritis, bursitis, myositis.
Is pain localized?.....	Arthritis, bursitis, localized infections, trauma.
Nausea or vomiting *.....	Viral myositis.
Diarrhea *	Viral myositis.
Urinary symptoms *.....	Urinary infections including prostatitis.
Muscle spasms	Muscle strain.

* Associated with musculoskeletal symptoms or signs.

DISEASES OF THE RESPIRATORY SYSTEM

13-1. Exchange of Gases

The cells of the body require oxygen for life. Oxygen is used by the cells and then converted to the waste gas, carbon dioxide, which is removed from the body. Oxygen and carbon dioxide are continually being exchanged, both between the body and the atmosphere and within the body. The respiratory system performs this essential exchange of gases, taking oxygen from the air and releasing carbon dioxide into the air.

13-2. Structure and Function of the Respiratory System

The respiratory system consists of the nose, paranasal air sinuses, pharynx, trachea, bronchi, lung, and diaphragm. Figure 13-1 depicts the upper respiratory organs.

a. The nose provides a passage for air, warms and moistens the inspired air, and removes dust. Fine hairs filter out coarse particles of dust and the lining of the mucous membrane traps fine particles. The mucous membrane also warms and moistens the air.

b. Paranasal air sinuses are passages lined with mucous membrane which warm and moisten the air and act as resonance chambers for the voice.

c. The pharynx, or throat, connects the nose and mouth with the lower air passages and esophagus (fig 13-1). It contains masses of lymphoid tissue, such as adenoids and tonsils.

d. The larynx, or voice box, connects the pharynx with the trachea. It forms the "Adam's apple" in the neck. During swallowing, the epiglottis closes the larynx, keeping food or liquid out of the trachea.

e. The trachea, or windpipe, is a tube which carries air from the larynx to the bronchi. It is held open by rings of cartilage.

f. The trachea ends as it branches into two bronchi, one bronchus going to each lung. These bronchi then branch into many smaller bronchi and even smaller bronchioles as they carry air to and from the millions of tiny air sacs (alveoli) in the lungs (fig 13-2).

g. The two lungs (fig 13-2) are the essential organs of respira-

FRONTAL SINUS

lightweight organ consisting mostly of "empty" air sacs called alveoli. It is in these air sacs that oxygen is absorbed into the blood and carbon dioxide is released from the blood.

13-3. Useful Descriptive Terms

- a. *Antitussive*. Relieving or preventing cough.
- b. *Apnea*. Absence of respiration.
- c. *Atelectasis*. A partial or complete collapse or airless state of the lungs.
- d. *Breast Bone*. The sternum.
- e. *Bronchitis*. Inflammation of the bronchi.
- f. *Cyanosis*. A bluish discoloration of the skin, especially around fingernails, toenails, lips, and ear lobes, due to lack of oxygen in the blood.

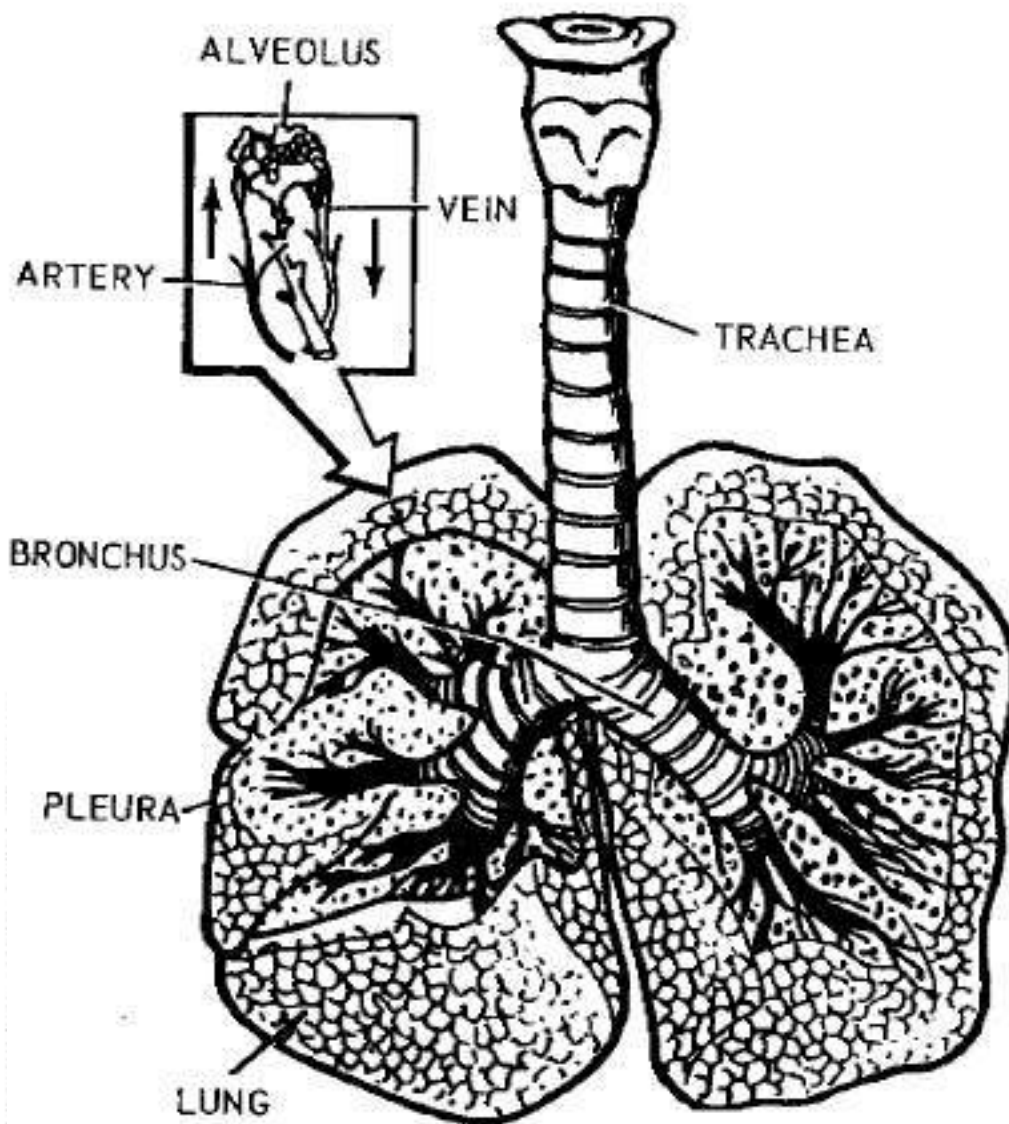

Figure 13-2. The lungs and air passages.

g. Embolus. A clot or other substance such as air or fat which travels through the circulation, lodges in a vessel, and obstructs the flow of blood.

h. Hemoptysis. The coughing up of blood or bloodstained sputum.

i. Infarct. Death of tissue because of a lack of blood supply.

j. Malaise. A vague feeling of bodily discomfort.

k. Neuralgia. Pain which extends along the course of one or more nerves.

l. Pallor. Paleness; absence of skin coloration.

m. Pleurisy. Pain due to inflammation of the pleura (pleuritis).

n. Pleural Effusion. Presence of excess fluids in the pleural cavity.

o. Pneumothorax. Air in the pleural cavity.

p. Pulmonary. Pertaining to the lungs.

q. U.R.I. Upper respiratory infection.

13-4. General Signs and Symptoms of Respiratory Diseases

a. Cough. An adequate history is essential for the proper evaluation of a patient with a cough. If the patient does not volunteer the information, ask him how long the cough has been present, whether it has been constant or intermittent, when it is worse, what aggravates it, the color and amount of sputum produced, whether associated symptoms such as shortness of breath are present, and whether he has a history of heart or lung disease. A cough will be either nonproductive (dry) or productive.

(1) A dry cough is seen early in the course of acute bronchitis, pneumonia, tuberculosis, and carcinoma (cancer) of the lung, or as the result of aspiration of a foreign body or an irritant into the airway. As any of these conditions persists, the sputum usually becomes mucoid (thick and white) purulent (usually yellow, green, or brown). Asthma produces large amounts of mucoid sputum. Sometimes pneumonia and bronchitis produce purulent sputum soon after the start of the dry cough.

(2) A productive cough is one in which the patient coughs up sputum. It is important to make sure the patient is talking about sputum and not saliva, which is always present. Sputum comes from the trachea or from deeper in the air passages. Sputum is usually classified as mucoid, purulent, or bloody. Mucoid sputum is typical of mild bronchial infections and allergies such as asthma. Purulent sputum occurs with bacterial infections such as in pneumonia or severe bronchitis. Bloody sputum may simply be streaked with small amounts of blood. This is a common result of any acute inflammation of the air passages, especially when a hacking cough is present. Sputum which is completely bloody generally has a

more serious implication. It is associated with traumatic chest injury, lung cancer, and tuberculosis.

(3) Management of a cough depends on its cause, type, severity, duration, associated signs and symptoms, and type of sputum. A patient with a cough which has been present intermittently or constantly for more than a week should be referred to a medical officer for evaluation. A dry, harassing cough associated not with temperature elevation but with other symptoms suggestive of a common cold may be relieved by a teaspoonful of terpin hydrate every 4 hours. The same treatment is proper for a cough producing small amounts of mucoid sputum. A patient producing a purulent sputum has a bacterial infection somewhere in his tracheobronchial tree, perhaps an acute bacterial bronchitis or pneumonia. He should be sent to a medical officer for evaluation. Any patient with bloody sputum must be seen by a medical officer.

b. Dyspnea (Shortness of Breath). Dyspnea is usually due to some form of body oxygen shortage. It occurs temporarily after exercise, for example. It may also be the result of diminished oxygen content in the surrounding air. This is best illustrated by the shortness of breath experienced by unacclimatized troops while working at an altitude higher than they are accustomed to. Any disease or injury that keeps enough oxygen from getting into the blood by the lungs can produce dyspnea. Likewise, a disease or injury that prevents proper circulation of the blood and oxygen to all parts of the body will cause dyspnea. A condition that impairs the nervous control of respiration so that breathing is no longer automatic also will cause dyspnea. Persistent dyspnea in the absence of strenuous exercise is a serious condition requiring evaluation by a medical officer. Consequently, if a patient complains of shortness of breath, ask how long the symptom has been present and whether he has just finished exercise. Emotional upset can produce dyspnea, but if it is persistent, the patient should be referred to a medical officer.

c. Chest Pain. Pain in the chest originates in the heart, chest wall, or abdominal organs. It may also be psychogenic—that is, produced by the mind in the absence of organic disease. Careful questioning about the nature of the pain will help you determine what is causing the chest pain. Pain involving the heart (cardiac pain) is discussed in paragraph 14-9.

(1) Pleural pain is caused by irritation or inflammation of the parietal pleura (pleurisy). It is due most often to infections, trauma, or cancer spreading from the lungs to the pleura. Pleural pain is usually characteristic. It may be present in either side of the chest and is well localized. The pain is aggravated by a deep inspiration, coughing, or sneezing, and is sticking, stabbing, or

cutting. It disappears if the breath is held in expiration. Often associated signs and symptoms are cough, sputum, fever, and dyspnea. A patient with pleuritic pain should be evacuated for evaluation.

(2) Pain arising in the outer structures of the chest wall (skin, muscles, ribs) is usually aggravated by deep inspiration, but disappears when the breath is held. Among the possible causes of this pain are a broken rib, intercostal muscle sprain, herpes zoster, inflamed rib cartilages, and nerve root irritation. If the patient twists or bends the thorax laterally while holding his breath, the pain recurs. The pain also often encircles one or both sides of the thorax, and a localized area of tenderness can be elicited in the region of the pain. Cough and fever may not be present. Dyspnea may occur. The pain is managed by local application of heat several times daily for $\frac{1}{2}$ hour, by massage, and by administration of two aspirin every 4 hours. If the patient does not improve within a week, he should be seen by a medical officer.

(3) Pain referred to the chest may be felt in any area from the tip of the shoulder to the lower rib margin. It is usually due to disease of abdominal organs near the diaphragm, such as the liver, gallbladder, stomach, transverse colon, or spleen. It is differentiated from disease in the chest by the presence of abdominal tenderness and symptoms referable to the abdomen, such as nausea, vomiting, distention, constipation, or diarrhea. Refer the patient to a medical officer as soon as possible. Do not give him anything by mouth or to relieve the pain.

(4) Psychogenic chest pain is precipitated by anxiety. It may mimic cardiac pain. The correct diagnosis is based upon your ability to question the patient carefully about upsetting events, duration of the pain, and what brought it on. The better you know the men you serve, the better you can detect psychogenic symptoms. One common cause of psychogenic chest pain is news that a close relative or friend has suffered a heart attack.

(5) For information on cardiac pain, see paragraph 14-9.

13-5. Upper Respiratory Infections

a. Common Cold (Acute Coryza). The common cold is caused by a virus. It is characterized by a watery, nonpurulent nasal discharge. Other symptoms include coughing, hoarseness with laryngitis, blockage of nasal passages, and sore throat. The patient may also have a mild fever of less than 101° F., general feeling of discomfort, and easy fatigability. The ordinary cold persists for several days to a week, gradually improving after 2 to 3 days. There is no specific treatment for coryza. Symptomatic treatment that may be used includes aspirin, antihistamines, cough syrup, increased intake of fluids, and rest.

b. Pharyngitis and Tonsillitis. These conditions are caused by invasion of the mucous membrane of the throat or tonsils by viruses or bacteria, especially streptococcus. Both conditions are characterized by severe sore throat, fever, intense inflammation of the throat, malaise, weariness, and often swelling of the lymph nodes and tenderness in the neck. The throat will show a fiery redness of the pharynx or the tonsils, or both. In streptococcal infections, white spots of pus may be present on the tonsils. Occasionally, an infection spreads from the tonsils to localize in the tissue around them, causing a peritonsillar abscess. Specific therapy includes antibiotics for bacterial pharyngitis and tonsillitis. Very helpful for sore throat of any cause is warm salt water gargle. Have the patient mix a teaspoonful of salt into a glass of warm water and gargle it for 5 to 10 minutes four times a day.

c. Influenza (Flu, Grippe). Influenza is similar to the common cold except that the symptoms are more severe. The primary cause of influenza is a virus; however, many secondary infectors may invade the body weakened by the influenza virus. The patient is listless, has headache and muscular aches, particularly in the back, and may feel very ill. His fever is usually moderately high, 101° to 103° F. He may also have a sore throat, watering eyes, nasal discharge, cough, nausea, and vomiting. A patient with the flu should be evacuated. Treatment is directed toward relieving the symptoms. Specific treatment for any secondary infection should be started early by the medical officer.

13-6. Lower Respiratory Infections

a. Acute Bronchitis. This is an inflammation of the mucous membrane lining the airways (bronchi) into the lungs. It may be caused by viral or bacterial infections or by physical or chemical agents. The outstanding symptom is cough. Other symptoms are general symptoms of infection such as fever and malaise. The cough may be nonproductive or productive of either mucoid or purulent sputum. Bronchitis usually is a mild disease of short duration, but it may progress into pneumonia in a debilitated patient. It is treated with rest, fluids, cough mixtures, and specific antibiotics prescribed by a medical officer.

b. Bacterial Pneumonia.

(1) The typical symptoms of bacterial pneumonia are chills, fever, cough, pain in the chest, and greenish-yellow sputum which may be streaked with blood. The temperature is high (102° to 104° F.). Pulse is fast (120-140). Respiration is fast. In a severe case, breathing is difficult and cyanosis is present. Chills are often the first symptom, appearing suddenly in an apparently healthy individual without previous symptoms. The pain in the chest is often severe and aggravated by breathing and coughing (pleuritic).

(2) You cannot treat pneumonia adequately in the field. The patient must be evacuated to a medical treatment site with laboratory facilities. Evacuation is usually by routine or priority, depending on the severity of the case.

c. Virus Pneumonia. This is also called primary atypical pneumonia. The symptoms are similar to bacterial pneumonia, except that they are often less severe. Therefore, diagnosis is more difficult without X-rays. The onset of virus pneumonia may be more gradual than that of bacterial pneumonia. The temperature is often lower and more variable than in bacterial pneumonia. The cough is seldom productive. Chest pains are described as more of an ache. Pulse and respiration are slower. An X-ray is often necessary to conclude a diagnosis of virus pneumonia. The patient must be evacuated to a medical treatment facility with complete laboratory and X-ray capabilities.

13-7. Asthma

Asthma is a chronic, recurrent allergic disease usually beginning in childhood. The patient is sensitive to an agent such as pollen which, when it enters his body, causes constriction of the smooth muscles of the bronchial tree, swelling of the mucous membrane lining, and increased secretions of the glands in the bronchial walls. This results in partial blockage of the air passages. The patient must forcibly exert his respiratory muscles to breathe. Asthmatic attacks usually last about 2 to 4 hours.

a. Characteristic of asthma is the wheezing noise of air being forced through the patient's narrowed and wet bronchial tree. Coughing spells often accompany the attack.

b. Ideal treatment of asthma consists of isolating the substance producing the reaction and either having the patient avoid the substance or desensitizing him against it. Desensitization is the procedure of administering the substance (foreign protein) in progressively larger doses as the body gradually accommodates to it. Acute asthmatic attacks are treated with antihistamines such as Tedral, Benadryl, or Pyrabenzamine. This is because large amounts of histamine are released during an attack and the histamine actually produces the symptoms. In extremely severe attacks, injections of epinephrine may be required to keep the airway open.

c. The best way to prevent asthma is to avoid the causative allergen. A soldier may need to be evacuated from a certain area if the allergen is abundant there.

13-8. Hyperventilation

Hyperventilation means abnormally rapid breathing rate. It is a common result of anxiety or fear, typical in combat situations. The patient may not be aware he is breathing too rapidly, and if

the hyperventilation is prolonged, a series of unusual and frightening symptoms occur. The rapid breathing produces an excess of oxygen and not enough carbon dioxide in the blood. The resulting shortage of carbon dioxide in the blood produces numbness of the hands, fingers, and other parts of the body; prickling of the skin; trembling; racing of the heart; light-headedness; fainting; cramping of muscles; curling of the fingers and toes; and extreme anxiety and apprehension. These symptoms frighten the patient and cause him to breathe even faster. This accelerates the symptoms, resulting in a vicious cycle. Hyperventilation is treated by slowing the breathing and elevating the concentration of carbon dioxide in the lungs. The patient must be reassured and firmly encouraged to slow his breathing. A paper bag, a poncho, or a field jacket, may be placed over the patient's nose and mouth to trap the exhaled carbon dioxide, forcing him to rebreathe it. The cover should be left in place for about six respirations and removed for another six. This cycling should continue until he is improved.

13-9. Differential Diagnosis

Dyspnea	Asthma, pneumonia, decreased O ₂ supply.
Chill	Pneumonia, malaria.
Productive cough	Bronchitis, pneumonia, asthma.
Nonproductive cough	Bronchitis, cold, flu, pneumonia, foreign body.
Watery sputum	Bronchitis, cold, flu.
Blood-streaked sputum	Pneumonia, tuberculosis, cancer.
Chest pain on exertion.	Cardiac, chest wall pain (chap 14).
Chest pain less when holding breath	Pleuritic pain, chest wall pain.
Chest pain with abdominal symptoms	Referred chest pain.
Rapid breathing	Pneumonia, asthma, bronchitis, hyperventilation.
Cyanosis	Pneumonia (severe), asthma (severe), chemical poisoning.
Sore throat	Bacterial or viral pharyngitis or tonsillitis.
Allergy	Asthma, hay fever.
Slightly elevated temperature.	Viral infections.
High temperature	Bacterial infections.
Fast or weak pulse.	Pneumonia, asthma, shock.

DISEASES OF THE CIRCULATORY SYSTEM

14-1. Circulatory System

Diseases of the circulatory (cardiovascular) system—the heart and the blood vessels—are the leading cause of death in the United States. They account for more deaths than the next five most common diseases combined. Every cell in the human body must have oxygen almost continuously to live. The circulatory system delivers life-sustaining oxygen in its blood to the cells. In addition, it carries the waste gas, carbon dioxide, away from the cells to the lungs for release into the air. In exchange, the blood picks up more oxygen to carry to the body cells. The main components of the circulatory system are the heart, which pumps the blood; the blood vessels (arteries, veins, and capillaries) which carry the blood; the blood itself; and the lymphatic system.

14-2. The Heart

The heart is a four-chambered pump consisting mainly of muscle tissue. It is about the size of two clenched fists (fig 14-1). Two of the chambers receive blood and two pump blood. The chambers on the right side are filled with blood containing much carbon dioxide. The upper chamber (right atrium) receives blood from the body while the lower chamber (right ventricle) pumps it to the lungs. The left chambers are filled with blood rich in oxygen. The upper chamber (left atrium) receives blood from the lungs while the lower chamber (left ventricle) pumps it to the body. Valves at the outflow sites and between the chambers allow the blood to flow in the correct direction only.

14-3. Arteries

Arteries convey blood away from the heart. Very small arteries are called arterioles. The system of arteries and arterioles is like a tree with a large trunk giving off branches which repeatedly divide and subdivide, becoming progressively smaller. When the heart contracts, it pumps blood into the arteries. The artery from the right ventricle to the lungs is the pulmonary artery. The artery from the left ventricle is the aorta. The aorta then branches to

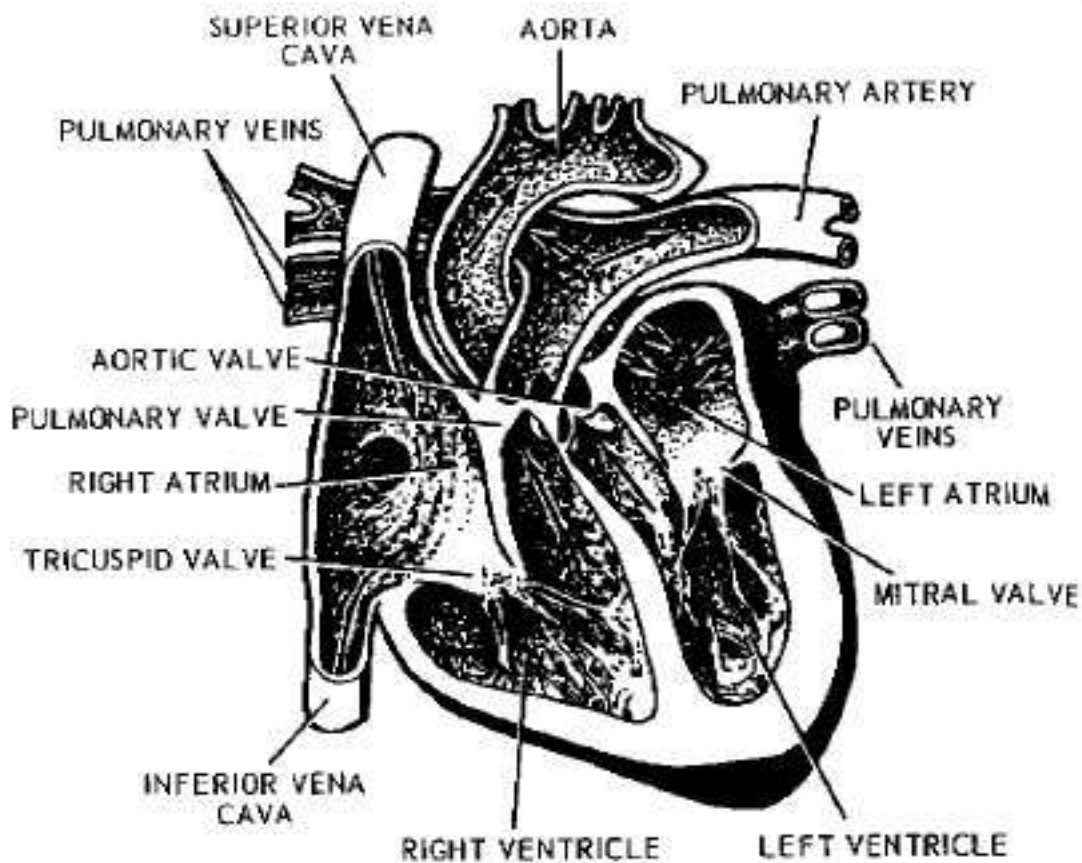

Figure 14-1. The heart and its parts.

supply all organs in the body. Pulse rate is measured by feeling blood pulse through an artery.

14-4. Veins

Veins return blood to the heart. The vein emptying directly into the right atrium is the vena cava. The veins emptying into the left atrium are the pulmonary veins. Very small veins are called venules. Veins are characterized by thin walls, low pressure, and valves which keep blood from flowing backward. Blood is moved through the veins by a combination of pressure from behind, squeezing of the veins by muscular contraction on them, and valves which allow the blood to move only toward and not away from the heart.

14-5. Capillaries

Capillaries, the smallest blood vessels, carry blood from the arterioles to the venules. Their walls are made of a thin layer of tissue. The thin wall permits exchange of fluid, oxygen, and carbon dioxide between the blood and the tissue cells.

14-6. Blood

a. Function. Blood functions primarily as a way of transporting substances from one part of the body to another. Blood carries

oxygen from the lungs to the cells, carbon dioxide from the cells to the lungs, food from the digestive tract to the cells, and wastes from the cells to the kidneys. Blood also functions in fighting infection, maintaining the body's temperature, and maintaining the body's chemical balance.

b. Components. Blood is made of plasma and cellular elements. The cells include red blood cells, white blood cells, and platelets, and comprise about one-half the volume of blood. Plasma, the fluid part of blood, forms the other one-half. Plasma is a clear, straw-colored liquid containing many substances in solution. Among them are water, gases, protein, fat, carbohydrates, inorganic salts, enzymes, hormones, and waste products.

(1) Red blood cells carry oxygen from the lungs to the tissue cells. Red blood cells are formed in the bone marrow. In the average adult, they number about 5,000,000 per cubic millimeter of blood. Red cells contain a pigment called hemoglobin, a compound of iron salt and protein, which gives the cell its color. In the presence of oxygen, hemoglobin becomes a brighter red. Therefore, blood in the left atrium just returning from the lungs will be much brighter red than blood in the veins just returning from the tissue.

(2) The function of white blood cells is to fight infection. They are able to ingest and destroy bacteria. They are also capable of amoeboid movement and can pass through capillary walls into surrounding tissues. An area of infection, such as a boil, is characterized by a great increase of white blood cells (leukocytes), which gather about the site and try to destroy the bacteria. Pus in a boil is mostly white cells, with bacteria and dissolved tissue. Diseases involving bacterial infection are generally accompanied by an increase in circulating white blood cells, as in appendicitis. White blood cells are formed in the bone marrow and number about 5,000 to 10,000 per cubic millimeter of blood.

(3) The main function of blood platelets is to aid clotting, or coagulation, of blood. Coagulation is the body's method of preventing excessive loss of blood when blood vessels are broken or cut open. Undisturbed blood circulates in its vascular system without clotting. When the blood leaves its natural environment, certain physical and chemical factors are changed, and the platelets break up to start the clotting process. Platelets are also formed in the bone marrow. They number about 250,000 per cubic millimeter of blood.

14-7. Lymphatic System

The lymphatic system consists of the lymph, lymph vessels, lymph nodes, and associated organs including the spleen.

a. Lymph is the fluid which passes out of the capillaries and bathes every cell in the body, supplying nutrient substances and

carrying away wastes. It returns to the bloodstream in the lymph vessels.

b. Lymph vessels start as open-ended ducts within the tissue spaces. As they travel up toward the heart, they unite with other lymph capillaries to form larger lymph vessels resembling veins. Lymph fluid drains from spaces between tissues into these vessels to be returned to the circulatory system. On the way, it passes through one or more lymph nodes.

c. Lymph nodes are small, oval bodies of lymphoid tissue which lie along the course of lymph vessels. Lymph nodes act as filters for the removal of infective organisms from the lymph stream. Normally lymph nodes cannot be felt through the skin. However, infections can cause lymph nodes to become inflamed and enlarged. Enlarged nodes may sometimes be felt in the groin, armpit, or neck following infections in those areas. Lymph vessels may become infected also in the area of local infections and appear as red streaks in the skin leading away from an infected wound. Other diseases of the lymphatic system are rare and will not be discussed here.

14-8. Useful Descriptive Terms

a. *Anemia*. A condition in which the number of red blood cells is below normal.

b. *Aneurysm*. Localized dilation of an artery.

c. *Aorta*. The major artery of the body.

d. *Arterial Pressure*. The force which causes blood to flow in the arteries away from the heart.

e. *Bradycardia*. Abnormal slowness of the heart beat.

f. *Cardio*. A word stem indicating the heart, as in cardiology—study of the heart.

g. *Carotid Arteries*. The principal arteries of the neck; they supply blood to the brain, face, and scalp.

h. *Congenital*. Existing at or before birth; usually refers to an abnormal condition.

i. *Constriction*. A narrowing or closing of a blood vessel; a feeling of tightness or pressure, as in the chest.

j. *Coronary Arteries*. Arteries supplying blood to the tissues of the heart.

k. *Digitalis*. A drug which increases the efficiency of contraction in a failing heart.

l. *Edema*. An excessive collection of watery fluid in the tissues.

m. *Embolism*. The occlusion or blocking of an artery by a clot (embolus) which has traveled through the circulation from another area of the body.

n. *Hem, Hema, Hemo, Hemato*. Combining forms (stems) mean-

ing blood. Examples: hematology, study of blood; hemoptysis, coughing of blood.

o. Hematoxic. Poisonous to blood.

p. Hemostat. An instrument for constricting a blood vessel to stop flow of blood.

q. Muscle Tone. A state of partial tension (contraction) always found in muscles.

r. Myocardial Infarction. Death of the heart muscle as a result of coronary occlusion (loss of blood supply).

s. Phlebo. A combining form indicating the vein, as in phlebitis, inflammation of a vein.

t. Stenosis. Constricting of a channel.

u. Thrombus. A blood clot inside a vessel which may block flow of blood.

14-9. Heart Attack

Although there are several diseases of the heart which can occur, most are uncommon and of no concern to you. However, a heart attack can occur anywhere, any time, without warning, and it may be fatal.

a. Signs and Symptoms. Heart attack is produced when one of the blood vessels to the heart muscle (coronary arteries) becomes blocked. The part of the heart which is deprived of blood dies rapidly. This usually produces severe chest pain which is generally described as "crushing," and is present in the middle of the chest. Because the heart is damaged, the pulse is often weak, rapid, and irregular. The patient appears severely ill. Sometimes heart attacks are preceded for months or years by many brief episodes of similar but milder chest pain occurring with exertion. This exertional chest pain, called "angina pectoris," indicates narrowing of the coronary arteries.

b. Treatment. The patient with a heart attack needs immediate hospitalization and should receive urgent evacuation. Until evacuation, rest, sedation, and oxygen are the best measures. Administer morphine ($\frac{1}{4}$ grain) for the chest pain. Angina pectoris should be fully evaluated by a medical officer. Indeed, any chest pain which is not readily identifiable as chest wall pain or pain from the abdomen should be referred to a medical officer as soon as possible. This is especially true if the pulse is irregular, rapid, or weak.

14-10. Diseases of Arteries and Veins

a. High Blood Pressure. High blood pressure is defined as blood pressure greater than 140/90. There are many causes of high blood pressure, including diseases of the kidneys and blood vessels and tumors of the adrenal glands, but in most cases the cause is

unknown. Psychologic factors may be present since more hypertension is seen in "worriers" and "hard drivers" than in other types of persons. The disease is dangerous because the high pressure damages various organs, especially the heart, brain, and kidneys. Treatment includes removal of the underlying cause if possible, drugs to lower the blood pressure, rest, sedation, and low salt diet. The individual should be evaluated by a medical officer.

b. Arteriosclerosis. This is a disease in which there is hardening of the arteries. The wall of the artery thickens due to the formation of fat deposits and fibrous tissue, thus narrowing the artery and interfering with the flow of blood. Blood clots may form, blocking the artery completely. No treatment for the disease is known. It usually affects older persons and may be a natural result of aging. It is especially dangerous when the coronary arteries which supply the heart muscle are affected, because a heart attack may result.

c. Thrombophlebitis. This is a disease in which a vein becomes inflamed and a clot forms in it. Symptoms include fever, tenderness along the course of the vein, swelling if the vein is in an extremity, and the presence of a hard, tender cord if a superficial vein is involved. Treatment is local heat, rest, and elevation if the extremities are involved. The patient should be referred to a medical officer. A serious complication of thrombophlebitis is pulmonary embolism, in which a clot breaks loose from the involved vein, travels through the right heart, and lodges in the pulmonary artery. This may cause death.

DISEASES OF THE DIGESTIVE SYSTEM

15-1. Anatomy of the Digestive System

a. The mouth, or oral cavity, is the beginning of the digestive tract (fig 15-1). Here, food is ground into small particles and mixed with saliva for swallowing. Saliva moistens food and makes it easier to chew and to swallow. Enzymes in saliva break starches into sugars, which is the beginning of chemical digestion. About 1,500 cc. of saliva is secreted daily.

b. The main function of teeth is to grind food to make it easier for enzymes to act upon and to lessen difficulty in swallowing. Chewing, swallowing, absorption, peristalsis, and defecation make up the mechanical part of digestion. Diseased or missing teeth may result in improperly chewed food, causing improper digestion deeper in the digestive tract. Swallowing large chunks of improperly chewed food adds to the work of the rest of the digestive tract.

c. The tongue is a muscular organ attached to the back of the floor of the mouth. The tongue works with the teeth by shifting and positioning food so that chewing can occur more efficiently. The tongue then propels the bolus (rounded mass of chewed food) from the mouth into the pharynx. This is the first stage of swallowing. Another function of the tongue is its use in speech and taste.

d. The pharynx is a muscular canal leading from the nose and mouth to the esophagus and larynx. Passage of food from the pharynx into the esophagus is the second stage of swallowing. During swallowing, the epiglottis closes the larynx so that food does not enter there but travels into the esophagus.

e. The esophagus is a muscular tube about 10 inches long, leading from the pharynx to the stomach. It is lined with mucous membrane and positioned directly behind the trachea. Its function is to complete the act of swallowing. Food is moved down the esophagus by waves of muscular contraction called "peristalsis." When vomiting occurs, the peristaltic wave is reversed.

f. The stomach is an expanded portion of the alimentary canal. It is an elongated, pouch-like structure lying just below the

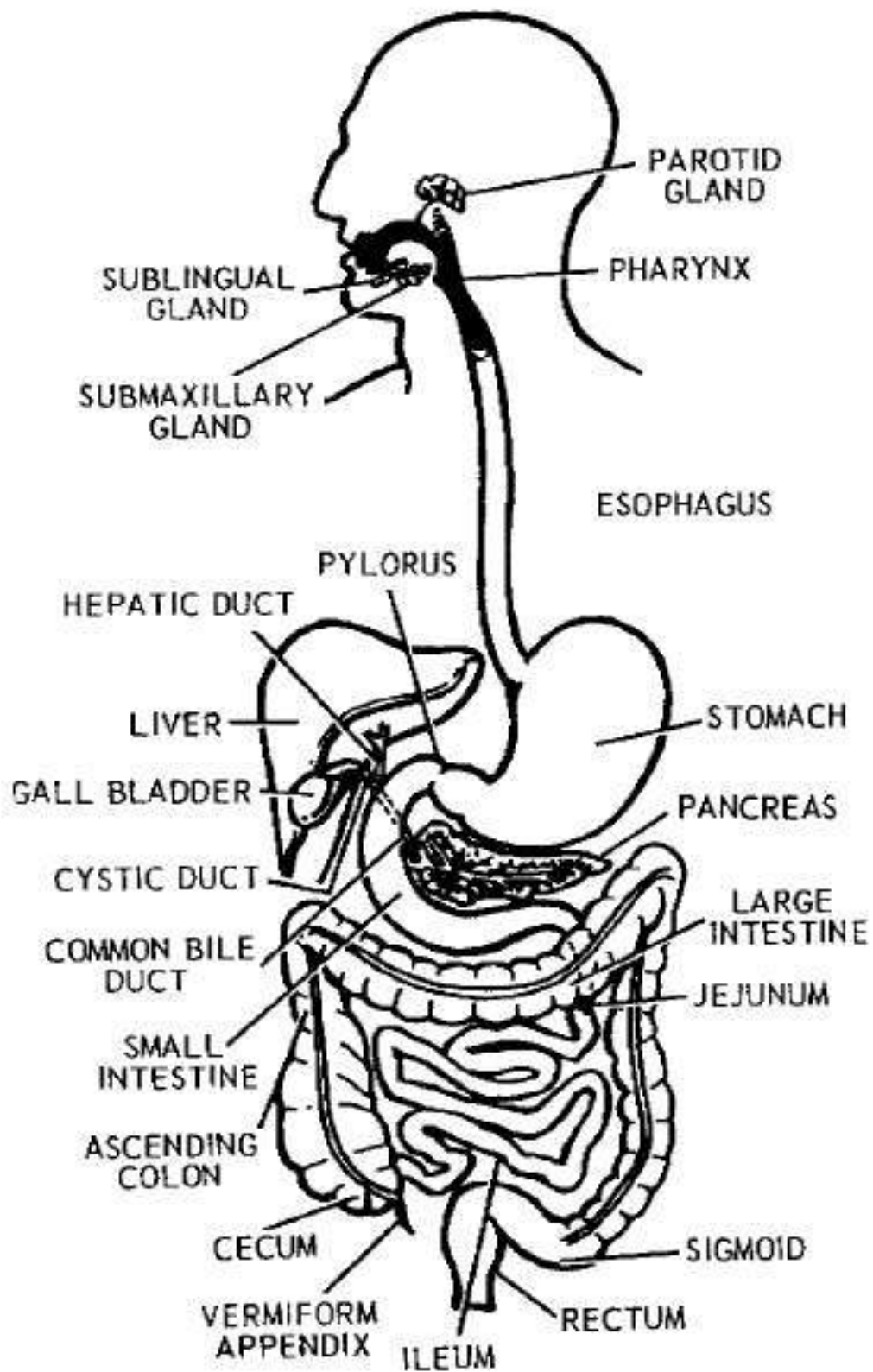

Figure 15-1. The digestive system.

diaphragm, mostly to the left of the midline. Circular sphincter muscles act as valves and guard the openings into and out of the stomach. The stomach has two main functions.

(1) The stomach is a reservoir for food. It expands when receiving food and contracts as it releases its contents through the pyloric valve into the duodenum. In addition, the stomach churns the food and breaks it down further for mixing with the gastric juices.

(2) Glands in the lining of the stomach produce gastric juices and hydrochloric acid. Gastric juices contain two enzymes which break proteins into simpler forms. Mucous membrane lining the stomach protects the stomach itself from being digested by the acid and enzymes. Food leaves the stomach as a semi-liquid.

g. The small intestine is a tube about 22 feet long. It extends from the pyloric valve to the cecum. The pyloric valve is a valve at the lower end of the stomach connecting to the upper end of the small intestine. This valve opens to allow the stomach contents to enter the small intestine. The cecum is the first portion of the large intestine. The small intestine is divided into three parts: duodenum, jejunum, and ileum. The duodenum is lined with small glands which secrete juices for digestion. The food is completely digested and absorbed into the bloodstream in the remainder of the small intestine. Only wastes and water remain to enter the cecum.

h. The large intestine is a tube about 5 feet long. It extends from its junction with the small intestine to the rectum. At the junction of the small and large intestines is the cecum, which is a blind sac located on the lower right side of the abdomen. Attached to the lower end of the cecum is the appendix, a tail-like structure about 3 inches long with no known function. The ascending colon portion of the large intestine extends along the right side of the abdomen from the cecum up to the region of the liver. There the large intestine bends and continues horizontally across the upper portion of the abdomen to the spleen. This portion is known as the transverse colon. The large intestine bends again and continues down the left side of the abdomen (descending colon). The lower portion of the large intestine (sigmoid colon) makes an S curve toward the center and rear of the abdomen and ends in the rectum. The primary function of the large intestine is the absorption of water from undigested food and waste it receives from the small intestine. As this mass passes through the large intestine, water is absorbed from it and into the circulatory system. What remains is waste or fecal matter. Fecal matter is stored in the rectum until defecation takes place.

i. The liver is a large organ located in the upper right portion of the abdomen. It is responsible for many chemical reactions

critical to life. In addition, the liver secretes a digestive juice called bile. Bile is stored in the gall bladder under the liver and enters the duodenum through the bile duct. The pancreas lies just to the left of the duodenum, under the stomach. Like the liver, the pancreas also secretes digestive juices which enter the duodenum through a duct (pancreatic duct). The pancreas also produces insulin which passes into the blood and controls the sugar in the body.

15-2. Useful Descriptive Terms

- a. *Anorexia*. Loss of appetite.
- b. *Diarrhea*. Frequent and watery fecal discharges; the opposite of constipation.
- c. *Enzyme*. A protein or other organic compound which speeds changes in the digestion of foods.
- d. *Feces*. The excrement discharged from the intestines.
- e. *Gastric*. Pertaining to the stomach.
- f. *Hematemesis*. Vomiting of blood.
- g. *Ingestion*. The act of taking in food for digestion.
- h. *Jaundice*. Yellow; yellowness of the skin and eyes.
- i. *Melena*. Black tarry bowel movement.
- j. *Metabolism*. The sum of the physical and chemical changes in the living cells by which the function of nutrition is effected after absorption; energy is provided for the vital activities and new material for repair.
- k. *Nausea*. A sick feeling in the stomach.

15-3. Gastric Conditions (Abdominal Pain, Nausea, Vomiting)

a. *Heartburn*. This is a condition in which an excess of hydrochloric acid is produced in an effort to digest an abnormal amount or kind of food. Acid fumes are expelled with gas from the stomach through the esophagus, producing a burning sensation. Since the esophagus is close to the heart, the patient complains of heartburn. Actually, it has nothing to do with the heart. It is treated with an antacid such as Gelusil.

b. *Indigestion*. This term is used when the stomach has difficulty breaking down and liquefying food. Indigestion may be caused by food that is not chewed enough and swallowed in large chunks, by bulky dry food eaten without enough liquid, or by dry food eaten while the body is dehydrated. Better eating habits and intake of more liquids may be the only treatment needed for indigestion. Antacids may be helpful. Indigestion associated with acidity may be a symptom of cardiac disease.

c. *Gastritis*. Highly seasoned food, some infections, excessive alcohol, and certain chemicals and medicines may irritate the lining of the stomach, resulting in nausea, loss of appetite, burn-

ing, pain, belching, vomiting, and hematemesis. Antacids may be helpful, but mainly the patient needs to be advised about his dietary habits. If the symptoms persist, especially with fever, infection is likely and the patient should be seen by a medical officer.

d. Peptic Ulcer. This is an open lesion (sore) in the lining of the stomach or duodenum. The lesions may be simple ulcers without severe inflammation or pain. They may produce intense pain, bleed, obstruct the stomach or duodenum, or they may perforate into the abdominal cavity. Peptic ulcers are related to stomach acid and to stressful situations such as worry, frustrations, and inability to adapt to changing situations. In the management of the peptic ulcer patient, consultations with the chaplain and psychiatrist are often a part of the treatment. Usual symptoms of peptic ulcer are pain and burning, which are more intense before eating, nausea, vomiting, hematemesis, loss of appetite, and frequent indigestion. Frequent small meals, administration of an antacid, and management of mental state are the main considerations in treating peptic ulcer. If you suspect peptic ulcer, refer the patient to a medical officer.

e. Food Poisoning. This is a term applied to a condition resulting from ingestion of foods containing certain microorganisms or toxins produced by them, poisonous shellfish, or foods contaminated with poisonous chemicals. Symptoms include vomiting, pain, and headache. In the field, treat food poisoning with large amounts of water and induce vomiting. Evacuate the patient as rapidly as possible.

f. Gastrointestinal Allergy. This is a disease manifested by nausea, vomiting, abdominal pain, and diarrhea after the patient has eaten certain foods. For example, some persons are allergic to eggs, strawberries, or seafood. Occasionally, the allergic reaction may involve other portions of the body and hives and wheezing may result. The disease is prevented by avoiding the offending food. Evacuation may be required for severe reactions.

15-4. Diarrhea

Diarrhea is the primary manifestation of disease of the intestine. When the intestines are diseased, they do not absorb food and water properly. As a result, food and water are excreted from the rectum. These watery bowel movements may number 20 or more a day, depending upon the cause and severity of the problem. The most common cause is infection, usually viral. The treatment for simple abdominal cramps and diarrhea is rest, fluids (usually oral), and medication, such as Kaopectate, to add bulk to the stool. Fluids are most important. Do not let your patient become dehydrated; that can be fatal. If either the cramping or diarrhea

worsens or does not improve in 2 to 3 days, refer the patient to a medical officer. If a fever accompanies the diarrhea, or if there is pus or blood in the stool, evacuate the patient. These circumstances may indicate a bacterial or parasitic infection of the intestines, which is much more serious than viral enteritis. Typhoid fever, cholera, and amebiasis are among diseases in this category. It is important to remember that most cases of diarrhea result from eating or drinking unclean foods or liquids or using unclean utensils. If you emphasize to soldiers the importance of using water purification tablets, eating only approved foods, and using clean eating utensils, you can do much to reduce the problem of diarrhea.

15-5. Abdominal Pain

Disease of almost any organ in the abdomen can produce abdominal pain. Pain in the upper part of the abdomen is common with simple indigestion or gastritis. Cramping pain in the lower part of the abdomen is common with viral enteritis and diarrhea. Yet, abdominal pain may be an important indication of a serious condition such as appendicitis. For this reason, never treat abdominal pain with analgesics such as aspirin or morphine unless the cause of the pain is obvious, as with a bullet wound, for example. Where the cause of the pain is not clear, observe the patient for several hours. If the pain lessens and disappears and the patient feels well, no further treatment is needed. If the pain remains the same or worsens, refer the patient to a medical officer. A helpful physical finding is *rebound tenderness*. This is tenderness evoked when the wall of the abdomen is *slowly* and *gently* compressed inward and then released suddenly. Sharp pain on the rebound indicates irritation of the lining of the abdominal cavity (peritoneum) and requires referral to a medical officer. Do not let the patient eat or drink anything. Rebound tenderness is present in fully developed appendicitis and in any severe abdominal infection. If a laboratory is available, a blood count can be done to help diagnose appendicitis. Usually the white blood cell count is elevated. However, a medical officer must make the evaluation in suspected appendicitis. If an infected appendix ruptures, the peritoneum becomes infected and death may result. Peritonitis, as this is called, is manifested by intense diffuse abdominal pain and board-like rigidity of the abdominal wall. The patient will tend to keep his knees drawn up to lessen the tension on the abdominal wall.

15-6. Intestinal Parasitic Infestation (Worms)

Worms from various origins may infect the intestinal tract. They are the roundworm, giant roundworm, hookworm, whipworm, pinworm, tapeworm, dwarf tapeworm, and beef, pork, and fish worm.

All may be ingested by eating contaminated foods or drinking contaminated water. Hookworms get into the body through the skin, usually the skin of the feet or lower legs.

a. Signs and symptoms are related to the type of worm infestation. Most symptoms include abdominal distress. Blood in the stool, anemia, and bowel obstruction are found in some cases. The most common presenting complaint is that the patient has seen worms in his stool.

b. Treatment depends on the identification of the specific worm involved. For that reason, the patient must be evacuated to an area where the stool can be examined by trained laboratory personnel. Drugs are available for treating specific types of worm infections.

c. Worms are spread through the intestinal discharges of the infected person. Food, water, and the hands are the most common vehicles for transmission of worms. Usually an entire family is infected. If one member of a family is infected with pinworm, the whole family should be treated. Reinfection or autoinfection is common, especially with pinworm.

15-7. Viral Hepatitis

a. Viral hepatitis is inflammation of the liver resulting from a specific viral infection. The virus may be transmitted by contaminated food, water, hands, needles, syringes, blood, or plasma. Signs and symptoms include jaundice, malaise, fever, nausea, vomiting, diarrhea, and clay-colored stool. A person may have the disease and show no signs or symptoms. He may recover from it and still have the virus in his blood. Hepatitis damages the liver cells so that the patient's liver cannot function adequately. Bile components, normally excreted into the intestine by the liver, instead "back up" into the bloodstream in hepatitis, coloring the skin and eyes yellow (jaundice).

b. There is no specific treatment for hepatitis. When it is diagnosed, the patient should be evacuated for rest, plenty of fluids, and a diet high in proteins and carbohydrates and low in fats. Preventive measures include using sterile or disposable syringes and needles. In addition, drinking water must be potable and food prepared under sanitary conditions. Good personal hygiene and sanitary discipline must be maintained. No vaccine for viral hepatitis is known.

15-8. Hemorrhoids (Piles)

Hemorrhoids are dilated veins in the wall of the rectum, or anal canal. If the veins are located at the junction of the skin and mucous membrane at the anus, the swelling protrudes from the anus and the hemorrhoids are external. If the veins are located in

the wall of the rectum, the swelling is not visible externally. In any case, they are often accompanied by pain on defecation, bright red rectal bleeding, and itching in the anal area. Relief may be obtained by the use of suppositories to lubricate the rectal walls and to soften fecal material. A local anesthetic, such as Dibucaine, may be mixed with a lubricant and applied to the affected area to relieve pain and to help elimination. Dehydration aggravates the condition. Hard, impacted fecal matter tears the hemorrhoids and makes them bleed. Constipation and straining at defecation may cause or aggravate hemorrhoids; therefore, a stool softener may be needed. In severe or chronic cases, the only recourse is surgical removal of the hemorrhoids.

DISEASES OF THE GENITOURINARY SYSTEM

16-1. Genitourinary System

The genitourinary system consists of the urinary organs for the production and discharge of urine and the genital organs, which are used in reproduction.

16-2. Urinary System

The urinary system is composed of organs for filtering and excreting wastes from blood. The urinary organs are two kidneys, two ureters, one urinary bladder, and one urethra. This system helps to control the water balance of the body. During formation of urine, wastes are removed from circulating blood for elimination.

a. Kidneys. The kidneys are bean-shaped organs about 4 inches long, 2 inches wide, and 1 inch thick. They lie on each side of the spinal column, against the muscles of the back, beneath the diaphragm and behind the peritoneum. The renal artery and renal vein enter each kidney at its central notch, the hilus. The kidneys filter the blood, remove liquid wastes (urine content), and retain in the circulation the usable portion to maintain the body's fluid balance.

(1) Acute pyelonephritis is an acute inflammation of the kidneys caused by bacterial infection. Bacteria may reach the kidneys through the bloodstream or a ureter. Infection is likely to occur if the free outflow of urine is blocked and urine stagnates.

(2) Symptoms of acute pyelonephritis include the sudden onset of chills, fever, pain, and tenderness in the upper back just below the ribs. Laboratory study of the urine may show pus cells (white blood cells). Pain during urination is a common symptom of kidney infection. Treatment includes a high fluid intake and specific antibiotics.

b. Ureter. The pelvis of each kidney is drained by the ureter, a muscular tube extending from the hilus to the urinary bladder. Some stones formed in the kidneys pass through the ureters to the bladder. Often, the passage of stones causes pain and lacerates ureter walls causing blood in the urine. A stone in the ureter may block the flow of urine and lead to an infection of the urinary tract

above the blockage because of stagnation. These symptoms may be confused with symptoms of other urinary inflammations. The ureters may also be infected by organisms invading either the kidneys or the bladder.

c. Urinary Bladder. The urinary bladder is a muscular sac which stores urine. It is located in the lowest part of the abdomen just behind the pubis, which is under the pubic hair. The bladder's size varies with the amount of urine it contains. The average bladder holds about 500 cc. When 200 to 300 cc. of urine collects in the bladder, sensory nerves carry a sensation of fullness to the brain, causing a desire to urinate. Urination involves relaxation of the bladder's sphincters and contraction of its walls which force urine out through the urethra.

(1) Cystitis, or inflammation of the bladder, may result from microorganisms traveling up the urethra into the bladder, traveling down the ureters into the bladder, or being introduced into the bladder during catheterization.

(2) The symptoms of cystitis are a burning pain in the region of the urinary bladder, burning pain with urination, frequency, urgency, and sometimes pus or blood in the urine. Cystitis will usually respond to antibiotics and a high fluid intake. The causative organism should be determined in the laboratory if possible so that the proper antibiotic can be chosen.

d. Urethra. The urethra is the tube that carries urine from the bladder to the outside. It is about 6 to 8 inches long in the male and about 1½ inches long in the female. The male urethra is divided into three parts: the prostatic, which passes through the prostate gland; the membranous, between the prostate and penis; and the anterior, the part in the penis. The only important urethral disease is urethritis (para 16-3).

16-3. Nonspecific Urethritis

Nonspecific or nongonococcal urethritis is not classed as a specific disease until the causative organism is identified. It may be traced to any of a number of causative organisms. Frequently, its cause is impossible to determine. Nongonococcal urethritis may be associated with syphilis, lymphogranuloma venereum, chancroid, protozoan infection, and certain fungus infections. Although not generally classed as a venereal disease, nonspecific urethritis may be venereal in origin.

a. Symptoms of nonspecific urethritis include a discharge or pain in the urethra, glans, testicles, perineum, and inguinal regions. The common types of urethral discharges are purulent, mucopurulent, and serous.

b. Smears from about one-fifth of the patients with urethritis show pus and epithelial cells, but often no organisms can be

demonstrated on culture. Nonspecific urethritis is differentiated from gonococcal urethritis by the absence of the gonococcal bacteria on smears of the discharge examined under the microscope and on culture of the discharge.

c. Treatment is directed toward the causative organism if it can be determined. The wrong antibiotic, especially in inadequate dosage, may mask the causative organism and make a positive diagnosis very difficult. If a specific organism cannot be found, a broad spectrum antibiotic such as tetracycline is often used. Antibiotics should be prescribed only by a medical officer after careful laboratory studies.

16-4. Useful Descriptive Terms

a. *Dys.* Prefix denoting painful or difficult urination, as in dysuria.

b. *Gonad.* Testicle or ovary.

c. *Hematuria.* Discharge of urine containing blood.

d. *Incontinence.* Inability to control voiding of urine.

e. *Purulent.* Containing, consisting of, or forming pus.

f. *Pyuria.* Pus in the urine.

g. *Renal.* Referring to the kidney.

h. *Scrotum.* Pouch containing the testicles.

16-5. Venereal Diseases

Venereal diseases are those diseases transmitted primarily by sexual intercourse or other close physical contact. Because of the lack of information and education and because of misinformation and fear about these diseases, many infected persons fail to seek adequate medical treatment. Education and information aimed at prevention, early detection, and adequate treatment are mandatory to control venereal diseases.

16-6. Gonorrhea

Gonorrhea is an infectious disease involving chiefly the mucous membranes of the genitourinary tract, rectum, and cervix. It occasionally spreads through the blood to serous and synovial membranes to other parts of the body.

a. The cause of gonorrhea is the gonococcus (GC) organism. It damages the epithelial tissue lining the urethra and produces pus. If a smear of the pus is made on a slide, stained properly, and placed under the microscope, the gonococcus is usually seen.

b. Typically, gonococcal disease in the male is dysuria, with or without pyuria. Frequently, dysuria with itching occurs 1 or 2 days before the pyuria. Patients refer to the pyuria as a "drip." The incubation period (interval between infection and onset of first symptoms) is 2 to 14 days. Some male gonococcal disease is

asymptomatic. Untreated gonococcal disease may spread through the bloodstream. Late effects of untreated gonorrhea in the male include stricture and sterility.

c. In the female, primary infection of the urethra, cervix, and rectum is usual. Gonorrhea in the female can be very difficult to diagnose due to early mild symptoms and inaccessible infected sites. The infection may go unnoticed in many cases. As the infection progresses, there is a purulent discharge which may also be unnoticed. Late effects may be pain and discomfort. If not treated, the infection may involve the uterus and fallopian tubes. If the gonococcus destroys the lining of the fallopian tubes, adhesions of the walls of the tubes may occur which could obstruct them permanently. This obstruction can result in sterility.

d. The drug of choice for treating gonorrhea in men or women is penicillin. The recommended dose for males in continental United States is 2.4 million units of aqueous procaine penicillin given intramuscularly. It is recommended that women receive 4.8 million units as initial treatment. All these patients should have a followup examination to insure adequacy of treatment. For infections resistant to penicillin and for individuals allergic to penicillin, tetracycline may be used. In all cases, treatment should be determined and supervised by a medical officer. Benzathine penicillin (long-acting Bicillin) causes the gonococci to develop resistance, and it must not be used in treating gonococcal diseases.

16-7. Syphilis

Syphilis is an acute and chronic venereal disease which may involve any organ or tissue. It may exist without symptoms for years.

a. Syphilis is caused by bacteria called spirochetes. It is usually transmitted directly from an infected person, or by transfusions of infected blood or plasma, or by passage from mother to fetus. The spirochete is fragile and will not live outside the human body, although it may survive in blood for transfusion. It is easily killed by sunlight, drying, antiseptics, and antibiotics, especially penicillin.

b. The spirochete usually passes from one person to another during sexual intercourse. Within 3 to 10 days a lesion may appear at the site of infection. This lesion, called "primary chancre," heals in about 7 to 10 days even if untreated. It is during the primary chancre phase that the individual is most likely to infect others. The lesion will usually be indented, or saucer shaped, and filled with a pus-like exudate. If the lesion is touched or probed, it produces little pain to the infected person. The lesion is said to be "painless." In fact, it may be small and never noticed by the patient. At this point, the patient should be directed to the labora-

tory, where a sample of the lesion will be placed under the microscope. The diagnosis then can be made by microscopic observation of the spirochete.

c. The lesion will disappear in a short time, with or without treatment, but the disease remains active in the body. The organisms enter the lymphatics and blood and go on to lodge in other tissue. Those which lodge in the skin and mucous membrane produce visible lesions and rashes, a condition called secondary syphilis. The organisms found in lesions of the skin and mucous membrane may infect other people. The organisms which lodge in the other organs such as the heart, brain, or liver destroy tissue. When these organs become involved, as long as 10 or 20 years later, the disease is called tertiary syphilis.

d. During the secondary or later stages of syphilis, the disease can usually be detected by a serologic blood test. The blood test becomes positive 14 to 90 days after infection. This is called a "serology," because blood serum is used in most laboratory tests for syphilis.

e. Penicillin is the drug of choice for the treatment of syphilis. The usual treatment is two doses of 2.4 million units given a week apart. If the infected patient is allergic to penicillin, tetracycline is the next drug of choice. Treatment must be directed by a medical officer. A serology should be done 2 months after treatment and repeated each 6 months until at least two negative results are obtained. It is the responsibility of the treating physician or medic to get the patient to return for these repeat serologies. There is no immunization against syphilis.

16-8. Granuloma Inguinale

Granuloma inguinale is characterized by granular, purulent lesions of the skin in the region of the groin, often involving the genitalia. If granuloma inguinale is left untreated, the organisms will spread over a large area and produce a large, foul-smelling ulceration. This ulcer tends to bleed freely. The incubation period is 1 week to 12 weeks, but once established, the lesion may spread quickly. Positive diagnosis is made in the laboratory. The drug of choice for the treatment of granuloma inguinale is tetracycline. As a rule, the older and more extensive the lesion, the longer the duration of therapy.

16-9. Chancroid

Chancroid is a highly infectious venereal ulcer which infects the genitalia of both men and women. It is spread by sexual contact. The ulcer is caused by a bacterium called *Hemophilus ducreyi*. Positive identification of the causative organism must be made in the laboratory. The sore, or ulcer, usually appears in 3 to 5 days

after exposure and grows rapidly. It has abrupt edges and a rough floor, and usually is painful and inflamed. Initially, it resembles a syphilitic ulcer. A syphilitic ulcer is painless, while the chancroid ulcer is very painful. The syphilitic lesion is usually singular and limiting in size. The chancroid ulcer may be multiple and enlarging. After the lesion heals, scar tissue remains. Major portions of the penis or vulva may be destroyed by chancroid if it is not treated promptly and adequately. Chancroid-like lesions must be evaluated by a medical officer so that a specific diagnosis can be made. Chancroid is treated with a sulfonamide.

16-10. Lymphogranuloma Venereum

Lymphogranuloma venereum usually starts with a small papule, which may be so small it is not noticed by the patient. This venereal disease is caused by a virus. Its symptoms which bring a patient to the dispensary are usually fever, headache, myalgia, and malaise. Swollen tender inguinal lymph nodes develop as the disease progresses. You should always suspect plague first when you see swollen inguinal nodes. Lymphogranuloma venereum responds to antibiotics and frequently requires hospitalization for much of the treatment.

16-11. Differential Diagnosis

Frequency	Pyelonephritis, cystitis, urethritis, prostatitis.
Urgency	Pyelonephritis, cystitis, urethritis, prostatitis.
Burning on urination.....	Pyelonephritis, cystitis, urethritis, prostatitis.
Retropubic pain	Cystitis.
Fever	Pyelonephritis, cystitis, prostatitis.
Pus-like discharge from urethra	Prostatitis, urethritis
Sore on penis.....	Syphilis, lymphogranuloma venereum, chancroid, granuloma inguinale.
Chills	Pyelonephritis.
Pain in upper back.....	Pyelonephritis.
Pain in lower back.....	Prostatitis.
Swollen inguinal lymph nodes..	Chancroid, lymphogranuloma venereum.

DISEASES OF THE NERVOUS SYSTEM

17-1. Nervous System

The nervous system may be divided into three main areas according to functions. They are the central, peripheral, and involuntary (autonomic) nervous systems.

17-2. Central Nervous System

a. Brain. The central nervous system is composed of the brain and spinal cord. It receives information from the peripheral and autonomic nervous systems. It evaluates the information, stores some of it, and sends appropriate responses. The main parts of the brain are the cerebrum, cerebellum, and medulla. The cerebrum receives, stores, interprets information, sends messages, and records general and special sensations. As the highest level of the nervous system, this is where thinking and memory take place. The cerebellum lies below the cerebrum. It coordinates muscular activity, regulates muscle tone, and serves as the center for reflex action and equilibrium. The medulla is found at the base of the brain near the spinal cord. It contains the centers for the control of blood pressure, heart rate, and rate and depth of respiratory movements.

b. Spinal Cord. The spinal cord is a cord of nervous tissue about 18 to 20 inches long located in the spinal canal inside the vertebral column of the back. The cord serves as a connecting cable of nerves between the brain and the rest of the body. It also contains some centers for basic reflex actions.

17-3. Peripheral Nervous System

The peripheral nervous system receives and transmits information between the outlying part of the body and the central nervous system. The system has two parts, sensory and motor. The sensory nerves carry impulses from the surface of the body to the brain. Impulses from the brain to the muscles travel along the motor nerves. The sensory and motor nerve fibers of the body make up the peripheral nervous system.

17-4. Autonomic Nervous System

Autonomic means self-controlling. For example, if the extremity muscles need more blood for an emergency, one part of the autonomic nervous system speeds the heart to pump more blood. Blood vessels in the muscles dilate so that more blood can get to them. Another part, meanwhile, will slow the organs of digestion and constrict their blood vessels, making this blood available for the muscles. When the emergency need no longer exists, the reverse action takes place. The autonomic nervous system also controls heart rate, breathing rate, intestinal motility, eye dilation, and many other functions.

17-5. Useful Descriptive Terms

a. *Anesthesia*. Loss of sensation; local anesthesia is a loss of sensation limited to a part of the body.

b. *Anxiety*. A feeling of apprehension, uncertainty, and fear, often accompanied by restlessness.

c. *Ataxia*. Loss of coordination.

d. *Bilateral*. Pertaining to or affecting both sides of the body.

e. *Conversion Reaction*. The unconscious conversion of an emotion into physical manifestations and *belief* by the patient that he is ill.

f. *Emotional Instability*. Inability to cope with a situation; given to easy rage, brooding, and widely fluctuating moods.

g. *Encephalitis*. Inflammation of the brain.

h. *Hemiplegia*. Paralysis of one-half of the body (arm and leg on one side).

i. *Hypnotic*. Drug which produces sleep.

j. *Neuralgia*. Pain which extends along the course of one or more nerves.

k. *Neuritis*. Inflammation of nerves.

l. *Neuropsychiatric*. Pertaining to mental or nervous disorders.

m. *Neurotoxic*. Poisonous to nerve tissue.

n. *Paralysis*. Loss of the power of motion.

o. *Paraplegia*. Paralysis of both legs.

p. *Poliomyelitis*. Acute viral infection involving the spinal cord.

q. *Psychogenic*. Originating in the mind.

17-6. Headache

One of the most common complaints of patients is headache. Most headaches are nonspecific and indicate no serious condition. However, frequent or very severe headaches may be a danger signal. Always check the blood pressure when headache is a complaint.

a. *Tension Headache*. Tension headache is the commonest type of headache. Tensing the neck and scalp muscles for long periods of time will tire the muscles and cause a headache. Tension head-

ache is often seen in men stationed on lookout or at a listening post. Continuous stress, like that placed on the "point-man" or scout, leads to tension headache. Drivers of tanks and trucks also complain of tension headache due to keeping their eyes fixed on the road for long periods of time. Continuous noise, or long periods of extreme quiet, will cause tension headache. Emotional stress also produces it. Tension headaches are relieved by rest, and the history essentially establishes the diagnosis. Aspirin is very helpful.

b. Other Headaches. If there is no history of physical or emotional stress and the headache is not relieved by rest or sleep, there is potential cause for concern. The patient should be seen by a medical officer, as he may have a serious or even life-threatening condition.

17-7. Unconsciousness

Unconsciousness means the patient is completely unaware of what is going on around him and is unable to make purposeful movements. Sleep is the only normal unconsciousness. Fainting is a brief unconsciousness. Coma is prolonged unconsciousness. Stupor is partial, transient unconsciousness. The commonest causes of abnormal unconsciousness are cerebral vascular accident (stroke), head injury, heat stroke, poisoning, alcoholism, hypoxia, and epilepsy. Acute alcoholic intoxication can suppress respiration and cause death. Often the cause of unconsciousness is not apparent. Until specific treatment can be started, do these things.

a. Examine the patient carefully. Be certain that his airway is not obstructed. Look for head injury, signs of bleeding, heat stroke, and poisoning.

b. Do not move him needlessly. Generally, it is best to let him lie in place.

c. Do not give him anything by mouth.

d. Do not give him morphine.

e. Refer the case to a medical officer.

17-8. Diseases of the Central Nervous System

a. Meningitis. This is an inflammation of the meninges, which are protective membranes surrounding the brain. The inflammation may be caused by a virus or one of many bacteria. Signs and symptoms include headache, stiffness of the neck, fever, and sometimes coma. In some cases, the signs and symptoms may progress extremely rapidly. Meningitis may be a life-threatening disease which can kill within hours of onset. Therefore, you must be alert to this possibility in any patient with fever and a stiff neck. Treatment depends on the type of organism found in the spinal fluid. The patient must be evacuated to a medical treatment facility with

adequate laboratory facilities as soon as possible. For bacterial meningitis, large doses of specific antibiotics will be given by the medical officer after performing a lumbar puncture and examining the spinal fluid under a microscope to determine the type of bacteria present.

b. *Poliomyelitis*. Poliomyelitis, or polio, is a viral infection of the central nervous system involving motor nerve cells in the spinal cord and brain stem. Some or all of these motor nerves may be damaged or destroyed, resulting in paralysis of the voluntary muscles. The disease is prevented by administration of the polio vaccine.

CHAPTER XXV: MANIFESTO

“Why did you write and compile this document?”

This is a question that I know will be asked. I will be answering it in this document since I do not want to get spammed. Since these are my opinions I will place these last. There are multiple reasons for this document’s creation, some ideological, some not. What follows are my opinions and reasons for writing this text, and you do not have to believe one thing of it. I will keep it brief.

Arming The People

In an optimal system, the people should be well informed and influence their rule in such a manner. Education can aid the process, but the people must be able to fight back in case of tyranny. This is best summarized by the quote “when government fears the people, there is liberty. When the people fear the government, there is tyranny.”

The people are not armed in many regions, and laws could change in places where arming yourself is legal. Then the people must know how to arm themselves with common items and know how to use them against the status quo. If the people in China would begin making Lutys, flamethrowers, ANFO, and propane bombs and use them against the enforcers of martial law in a large scale, rest assure that the system would have to change. “Who, if not you? When, if not now?”

The people can not just be armed. The people must act. Stop waiting and talking, start making and doing. See how much one Breivik managed to shake up Norway, or one McVeigh or one Mateen in the USA. Imagine if there were 10 more.

I would advise to adopt a strategy more like McVeigh’s than Breivik’s or Mateen’s. The people will not become revolutionary if they become the targets. Attack the status quo: politicians, police, military, bankers, CEOs, and influential journalists. In the system 1 politician’s life will be more important than the deaths of 69 on Utøya. See John F. Kennedy, Olof Palme and Yitzhak Rabin.

Of course the attack must be well planned. The assassination of Kennedy caused the Cuban crisis. Another example would be the communists who bombed the St Nedelya Church, who failed to assassinate the leaders of the very top and caused their own downfall. Ensure that anti-status quo intelligence is high and up-to-date.

And stop with the ‘who shot first’ nonsense! Did we shoot Vicki with her baby or did the system enforcers? Or did we firebomb the Gaza strip? They are boiling the frog slowly and we must react before it is too late. It is soon too late: what is stopping the USA and the EU from implementing a credit system like the Chinese?

Accelerationism

I am an accelerationist of sorts. I do not care who helps with destroying the status quo, fascists, communists, jihadists, or anarchists, since I believe that the outcome will be better regardless. In the fallout of the fall of the status quo, the groups that caused its fall will get to fight out. Eventually the most powerful will take power. I believe I already know the outcome, but I have no power to read the future.

Nonsense

Nonsense! There is so much nonsense on the internet! I have read some guides, such as the Terrorist's handbook, Anarchist Cookbook and the SS Paladin manual, and all are so awfully written. The SS manual begins with about 40 pages of nonsense ideology and then has some truly bad instructions. Some of the instructions were very good, but a lot awful. I especially liked the random photographs of Hitler in the instructions for making ammunition (see page 513 of SS).

This is the instructions for making a car bomb:

- Newspaper
- Fertilizer (the chemical kind, Ammonium Nitrate)
- Cotton
- Diesel fuel
- A vehicle which has been mostly gutted internally for more space

Make a pouch out of the newspaper and put some fertilizer in it. Then put cotton on top. Soak the cotton with fuel. Then light or remotely ignite the mixture."

Seems like all those pages I compiled from Breivik were a waste. What would he know? It is not like he bombed a building with ANFO. I also think some of the propaganda is supposed to aim for a female audience? Women, famous for becoming terrorists and soldiers. I do not know you be the judge (see page 86 of SS). The whole thing is also 666 pages long. Funny.

The instructions from the Terrorist's handbook and the Anarchist cookbook are no better. You would blow your face off attempting those! I do not want someone against the system to be terribly mutilated or killed, or some teenager who thinks it would be cool to synthesize nitroglycerin.

Last Words

I hope this document helped you and your operation. Just do not kill ordinary citizens, please. They should be converted not killed. I dedicate this document to Timothy James McVeigh, Andrew Joseph Stack III, Mir Aimal Kanshi and Yang Jia. And of course, this document is for educational purposes only! You can not sue me now!

Farewell.

-Anonymous.

"I explain herein why I bombed the Murrah Federal Building in Oklahoma City. I explain this not for publicity, nor seeking to win an argument of right or wrong. I explain so that the record is clear as to my thinking and motivations in bombing a government installation.

I chose to bomb a federal building because such an action served more purposes than other options. Foremost, the bombing was a retaliatory strike; a counter attack, for the cumulative raids (and subsequent violence and damage) that federal agents had participated in over the preceding years (including, but not limited to, Waco.) From the formation of such units as the FBI's "Hostage Rescue" and other assault teams amongst federal agencies during the '80's; culminating in the Waco incident, federal actions grew increasingly militaristic and violent, to the point where at Waco, our government – like the Chinese – was deploying tanks against its own citizens.

Knowledge of these multiple and ever-more aggressive raids across the country constituted an identifiable pattern of conduct within and by the federal government and amongst its various agencies. (see enclosed) For all intents and purposes, federal agents had become "soldiers" (using military training, tactics, techniques, equipment, language, dress, organization, and mindset) and they were escalating their behavior. Therefore, this bombing was also meant as a pre-emptive (or pro-active) strike against these forces and their command and control centers within the federal building. When an aggressor force continually launches attacks from a particular base of operation, it is sound military strategy to take the fight to the enemy.

Additionally, borrowing a page from U.S. foreign policy, I decided to send a message to a government that was becoming increasingly hostile, by bombing a government building and the government employees within that building who represent that government. Bombing the Murrah Federal Building was morally and strategically equivalent to the U.S. hitting a government building in Serbia, Iraq, or other nations. (see enclosed) Based on observations of the policies of my own government, I viewed this action as an acceptable option. From this perspective, what occurred in Oklahoma City was no different than what Americans rain on the heads of others all the time, and subsequently, my mindset was and is one of clinical detachment. (The bombing of the Murrah building was not personal , no more than when Air Force, Army, Navy, or Marine personnel bomb or launch cruise missiles against government installations and their personnel.)

I hope that this clarification amply addresses your question.

Sincerely,

Timothy J. McVeigh."

