

# H-CELL 2.0

## Assembly guide\*



### H-CELL 2.0

21st century power system  
for 1/10 RC hobby racing



## **SAFETY INFORMATION** please read before proceeding to assembly

*Equipped with high performance running battery and motor, R/C car models are capable of speeds of over 50km/h. Operating R/C models in improper areas may result in accidents causing injury or property damage. Follow the instructions outlined below to fully enjoy operating your R/C car.*

1. Operate R/C models in appropriate areas only.
  - a. **Never run R/C models on the road.**
  - b. **Never run R/C models in a crowded area or near small children.**
  - c. **Do not run R/C models in a narrow space or indoors.**
2. Never touch any rotating parts such as wheels, shafts or gears, as your finger, hair, clothes etc. may get caught leading to serious injury.
3. When not in use, always disconnect and remove battery and hydrogen canister.
4. Do not disassemble the battery , the fuel cell, the HYDROSTIK PRO cartridges or cut the cables.
5. Make sure you recharge the battery and fuel cell correctly, please follow the instructions.
6. After use, battery retains heat, wait until it cools down before recharging. Please dispose of battery responsibly. Never put battery into fire.
7. Immediately stop running if your R/C model gets wet, as may cause short circuit.
8. Do not tamper, disassemble or puncture the HYDROSTIK PRO cartridges.
9. Keep assembled R/C MODEL and /or HYDROSTIK PRO cartridges away from fire, open flame, or heat source.

# H-CELL 2.0 Parts list

- A. Fuel cell unit
- B. Pressure regulators
- C. Hydrogen cartridges
- D. Electronic Valve Support
- E. Electronic Control Box
- F. Aluminum support plate
- G. Silicon rubber tubing
- H. Four-port connector
- I. Fasteners
- J. Spanner
- J1. Screw driver
- K. Wiring protection covers
- L. Aluminum plate connectors
- M. Plastic tie
- M1. Silicon sheet
- M2. Filter

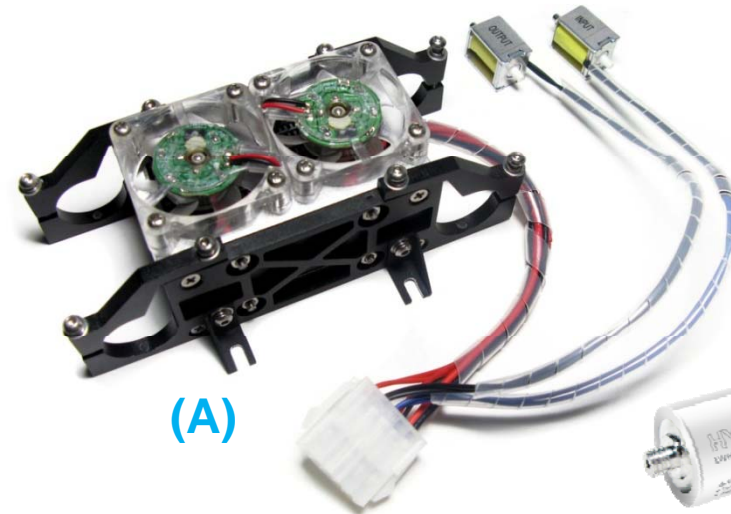

(A)



(B)



(D)



(C)

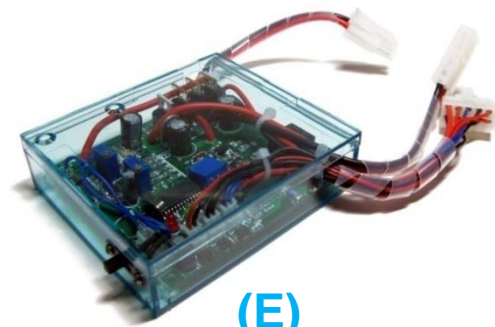

(E)



(L)

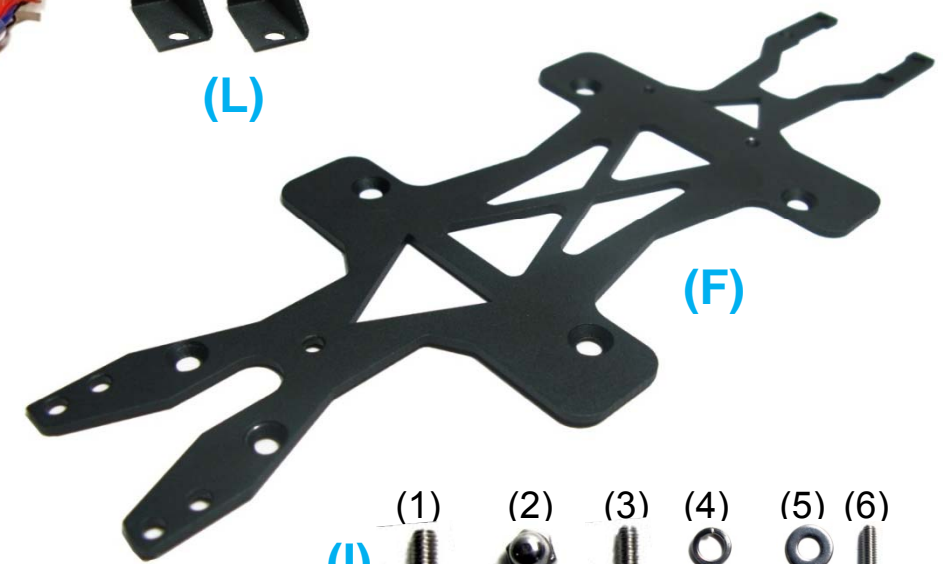

(F)



(K)



(J)



(J1)



(M)



(H)



(G)



(M1)



(M2)



(I)

# Recommended RC vehicle\* parts list

*(not included in the H-Cell 2.0 kit)*

	Item	Supplier	Ref. number
(N)	Chassis	TAMIYA	TRF416/416X/417
(O)	Speed controller	TAMIYA	TBLE -01
(P)	Servo motor	Futaba	BLS551
(Q)	RC transmitter/receiver	Futaba	2PL
(R)	Lithium Battery	SE	2800-4000mAh/7.4V
(S)	Motor	TAMIYA	3.5T brushless
(T)	Motor heat sink**	TAMIYA	** Optional part
(U)	Tires	TAMIYA	Super slicks
(V)	Inner tube	TAMIYA	
(W)	Hubcap	TAMIYA	

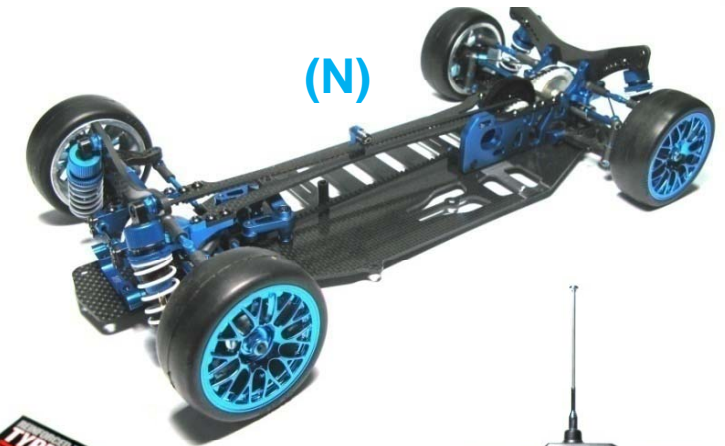

(T)

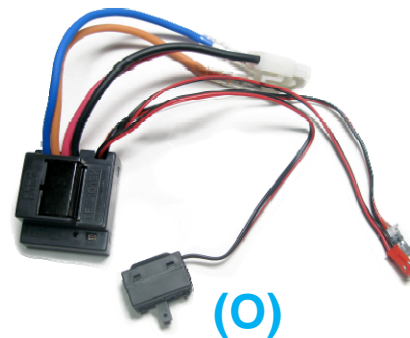

(O)



(U)



(R)



(P)



(Q)



\*standard integration based on using TRF416/416X/417 chassis from TAMIYA

# H-CELL 2.0

## Standard Integration Design

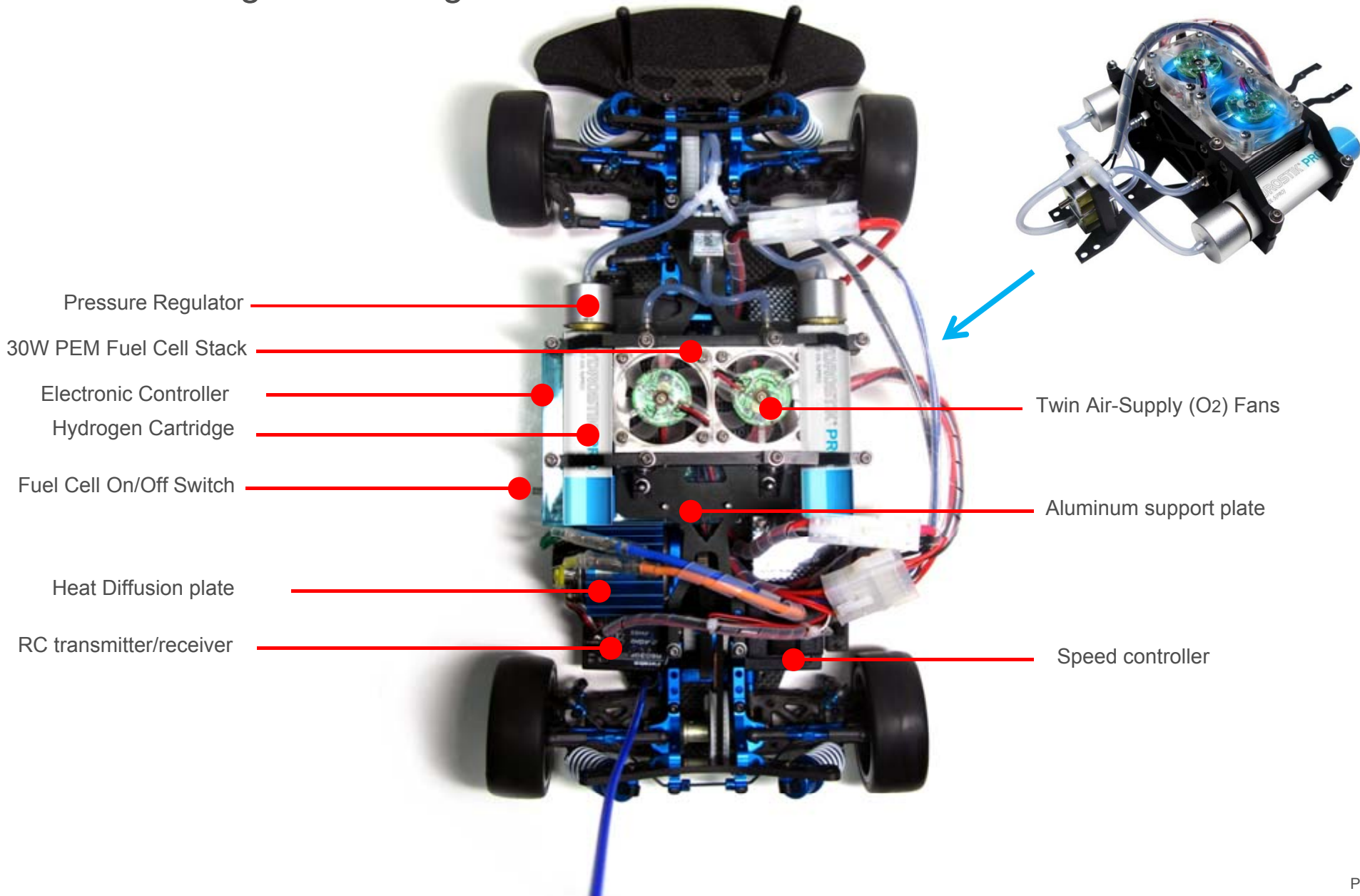

*\*standard integration based on using TRF416/416X/417 chassis from TAMIYA*

**STEP 1:** Custom (adjusted) assembly of the TAMIYA TRF416/416X/417 CHASSIS\*

- A. Purchase all the necessary parts (see Recommended RC Vehicle Part list)
- B. Follow the TRF416/416X/417 chassis assembly manual, but adjust with the following steps:

**Step 05:** Cancel installation of “Drive Belt (Long)”

**Step 10:** Cancel “attaching upper deck”

**Step 26:** Installation of steering servo Futaba BLS 551\*\* (see recommended, part list)

**Step 27:** R/C unit location should be changed (see step 2 in this manual)

**Step 28:** Cancel “securing cables”

**Step 30:** Cancel installation of B7 “rear body mounts”

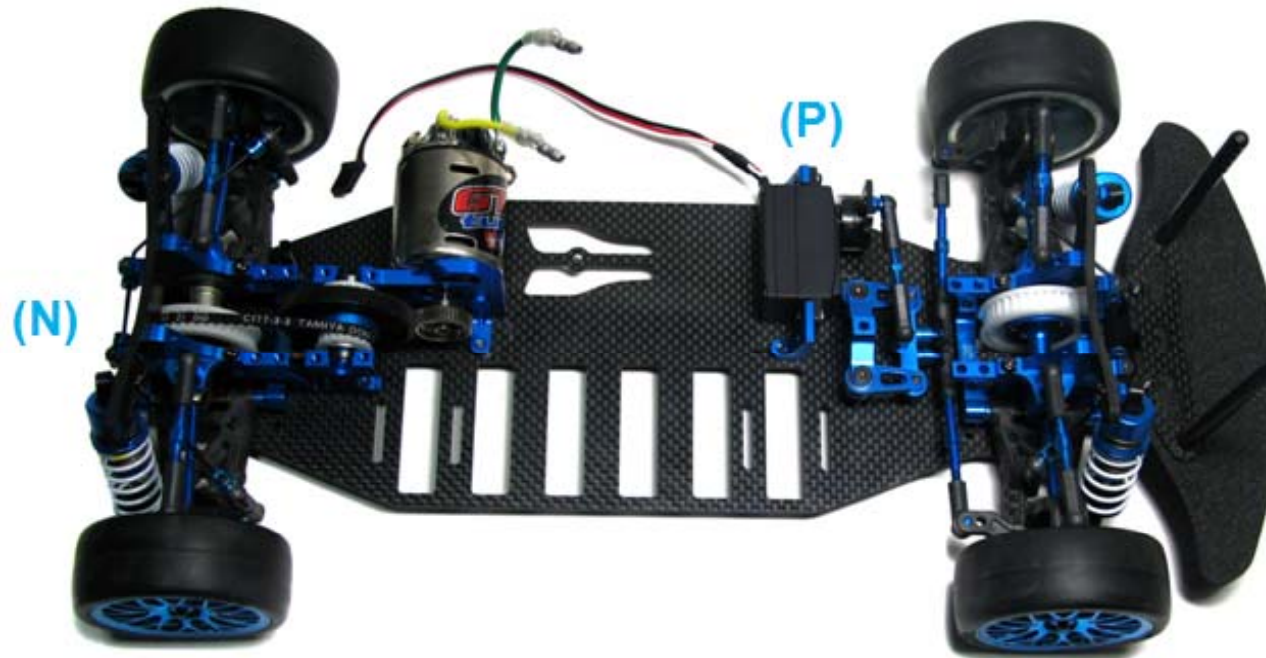

*\*Although we recommend TRF416/416X/417 from TAMIYA and our aluminum support plate is designed around this model, the H-cell 2.0 kit could be adapted to various RC vehicles and boats with some additional engineering.*

*\*\*We recommend Futaba BLS 551 due to its smaller size.*

**STEP 2:** Use black double-sided tape to attach the antenna's signal receiver (Q)\* to the chassis (N).

\* See recommended parts list (Horizon recommends using FUTABA 2PL for this assembly)

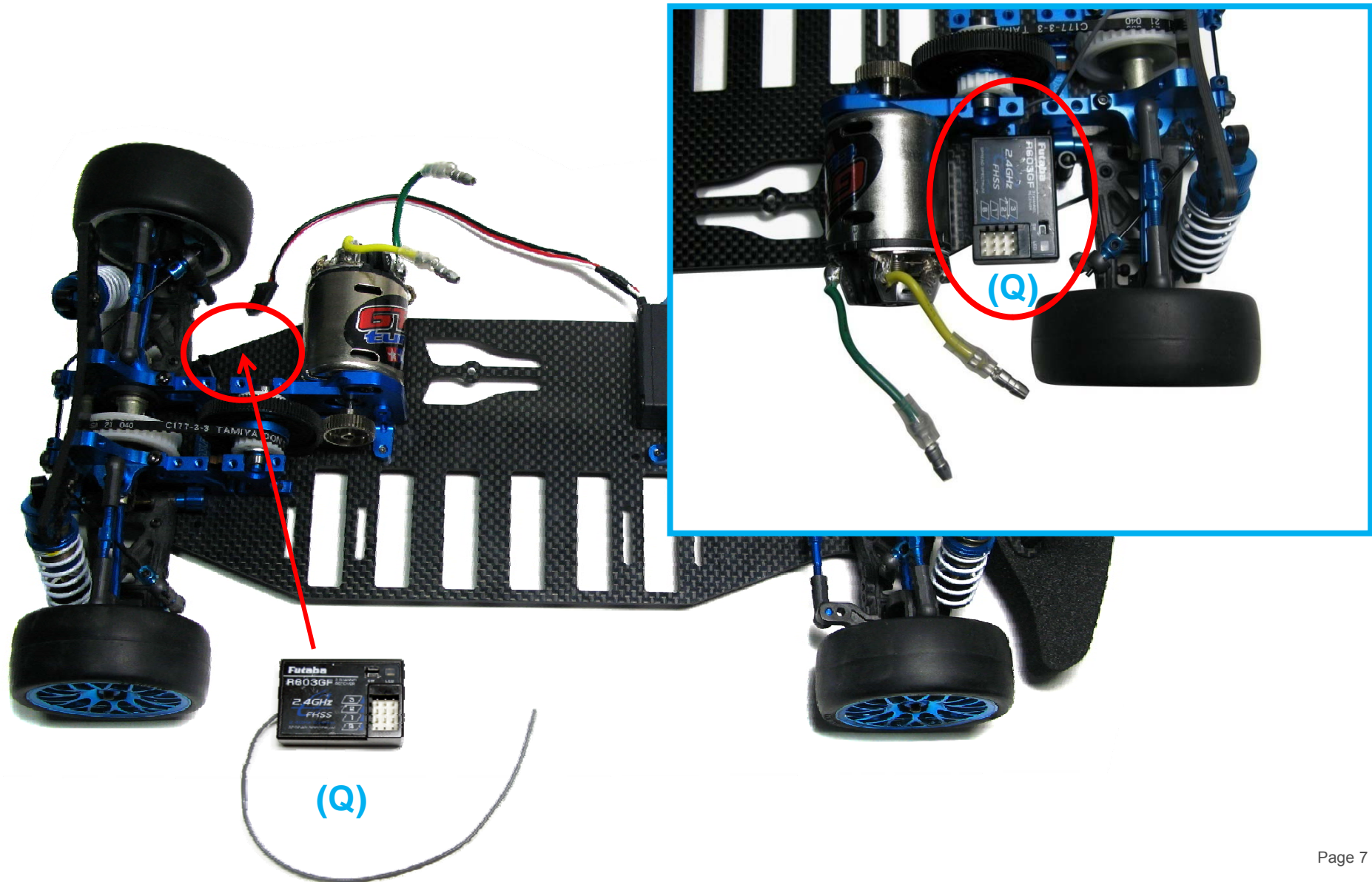

**STEP 3:** Place the wiring protection covers (K) onto the wires of the speed controller\* (O) as below

\*See recommended parts list (Horizon recommends the TAMIYA TBLE-01 speed controller for this assembly)

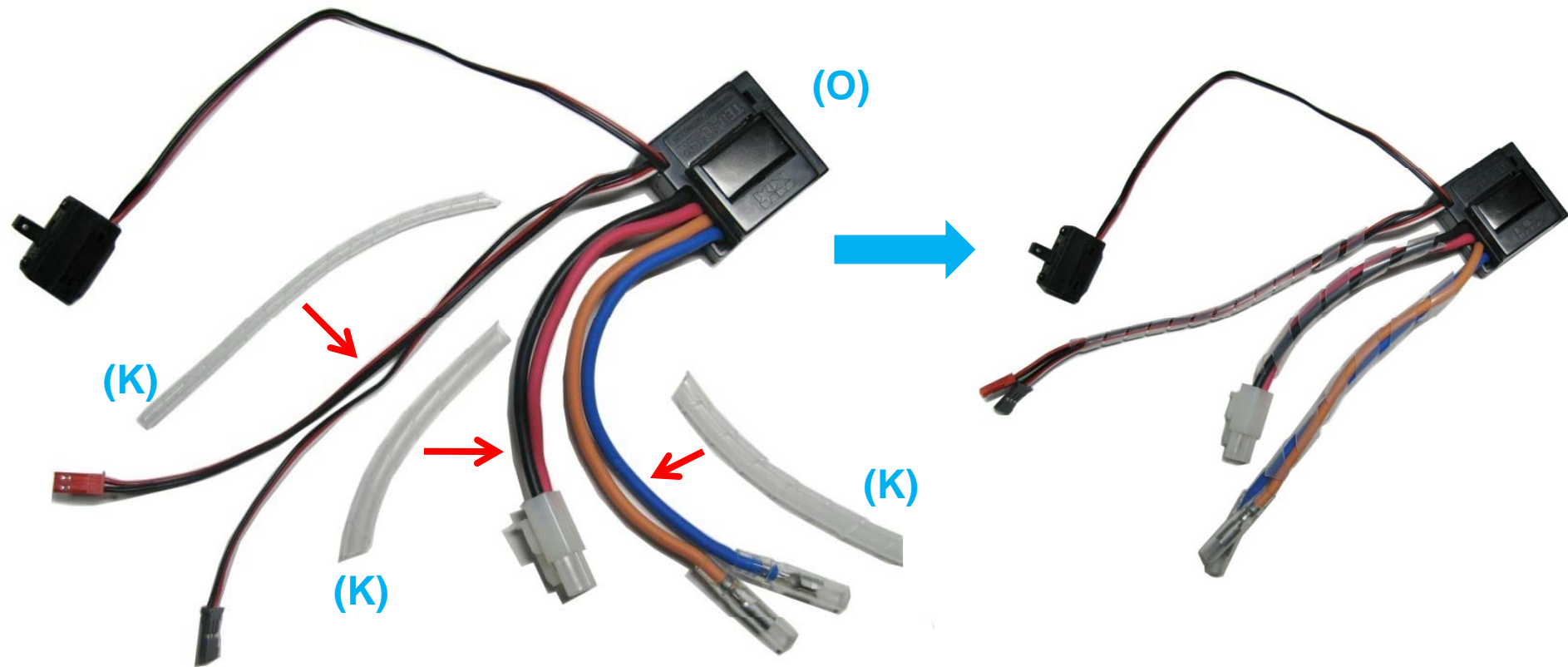



**STEP 4:** Use black double-sided tape to attach the speed controller\* (O) to the chassis (N).

\*See recommended parts list (Horizon recommends the TAMIYA TBLE-01 speed controller for this assembly)

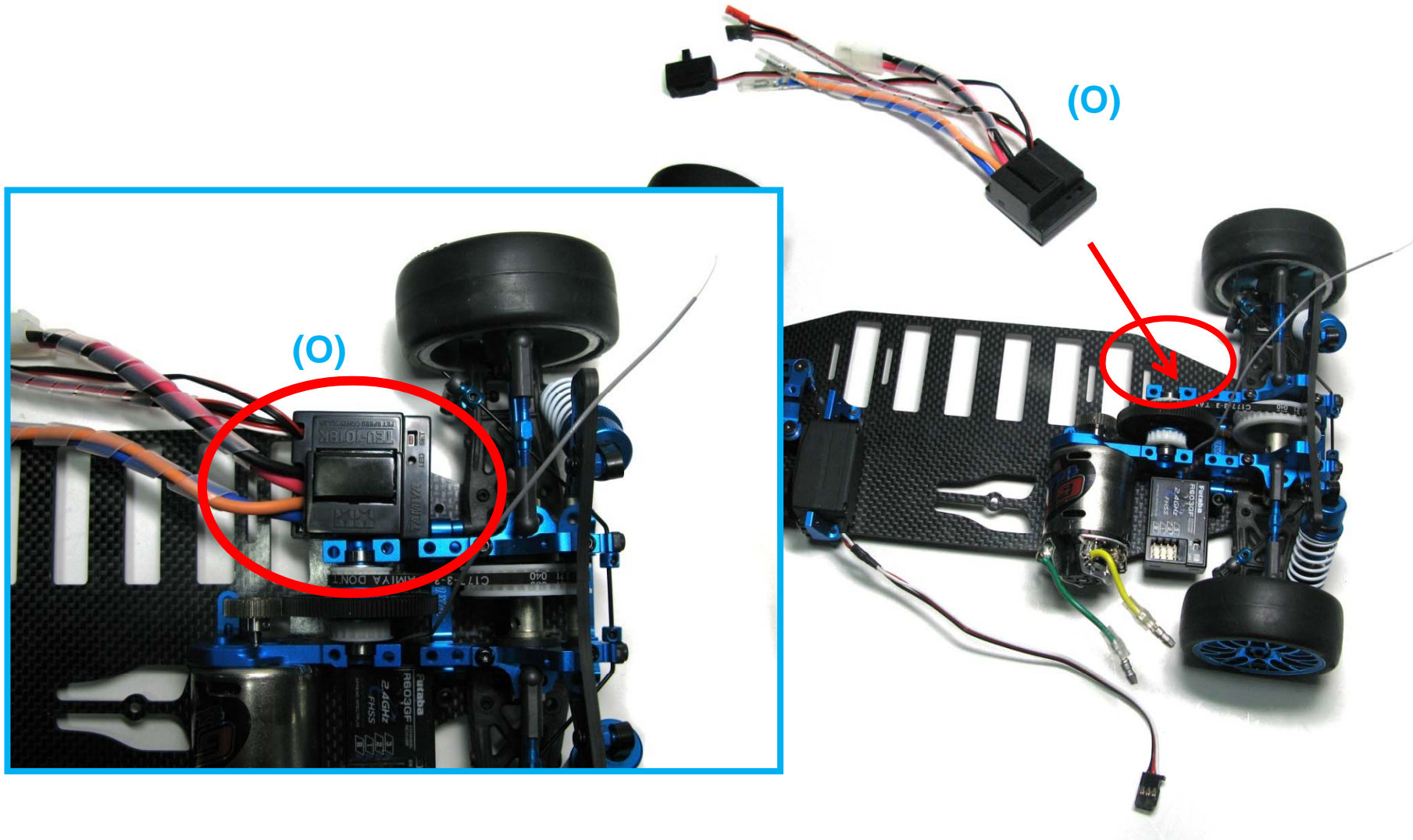

**STEP 5:** Use black double-sided tape to attach the speed controller (O)\* switch to the chassis (N).

*Paste speed controller On/Off switch onto outer side of speed controller (O)*

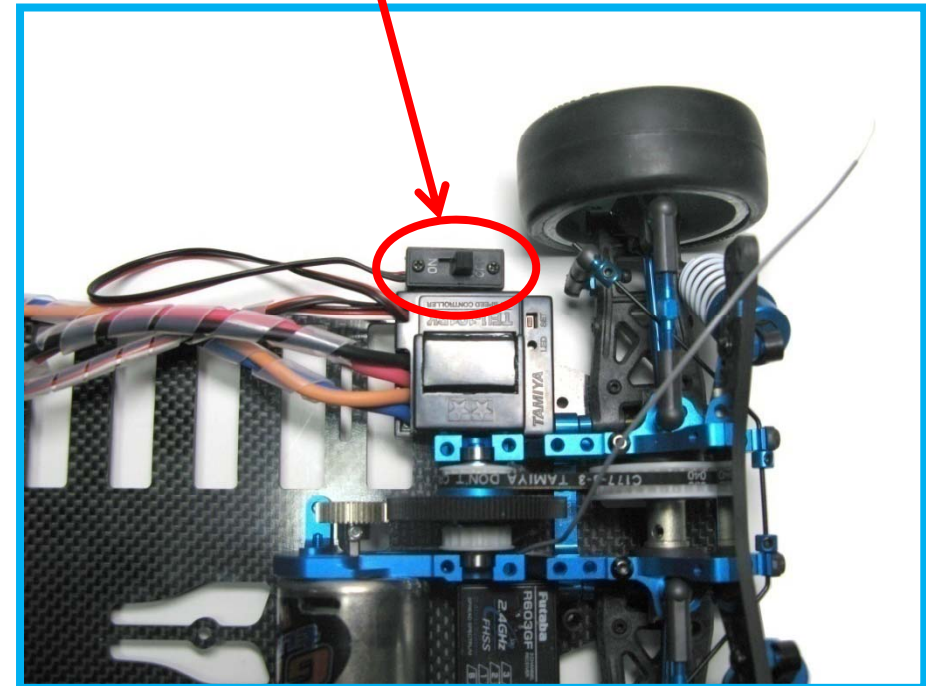
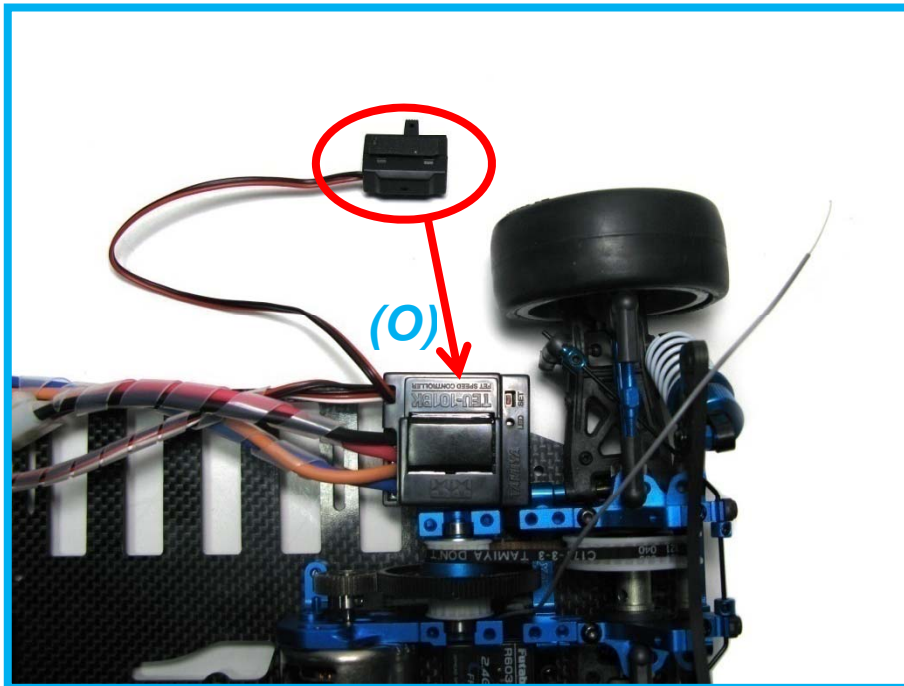

**STEP 6:** Insert the red plug and grey plug from speed controller (O) into socket “B” of signal received (Q) and black plug from the servo motor (P) into socket “1”.

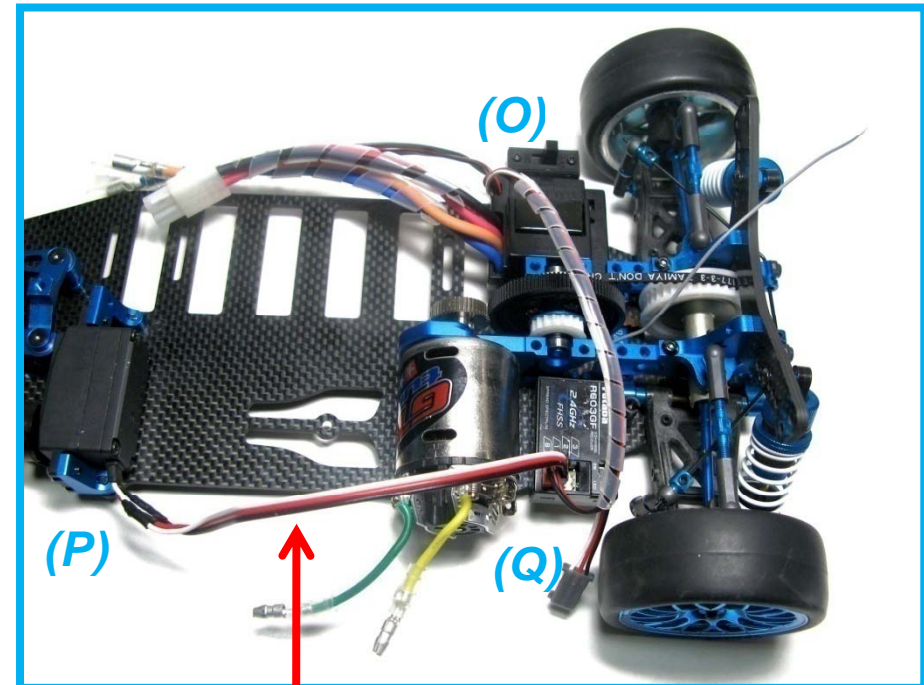
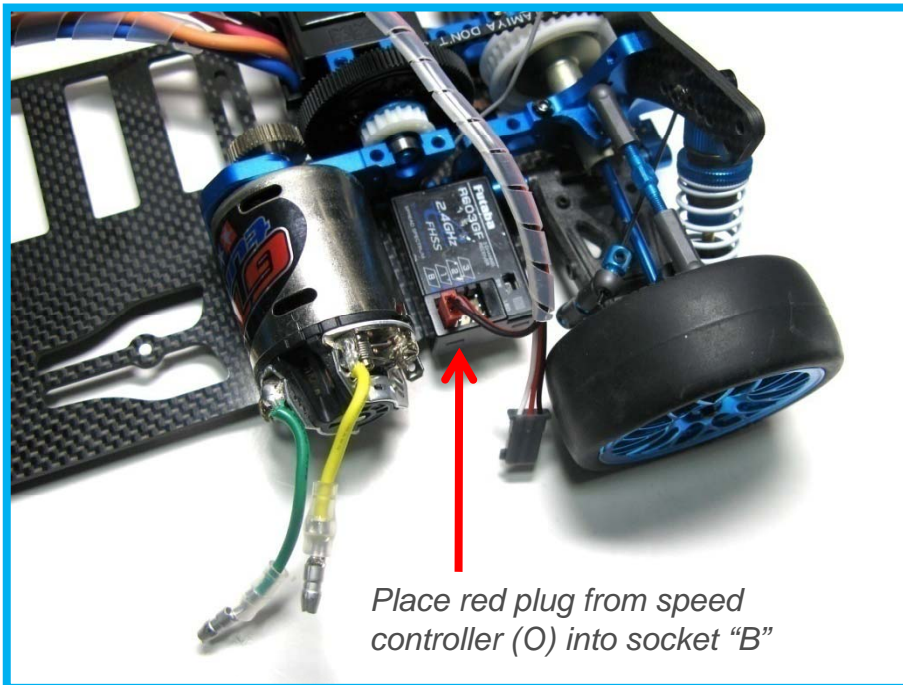

**STEP 7:** Insert the grey plug from speed controller (O) into socket “2” of the antenna’s signal receiver (Q).

Use a plastic tie (part M) to attach the cable to the chassis (N) together so wire doesn’t hang from chassis.  
**Make sure all the connections are correct. Pay attention to the plug direction.**

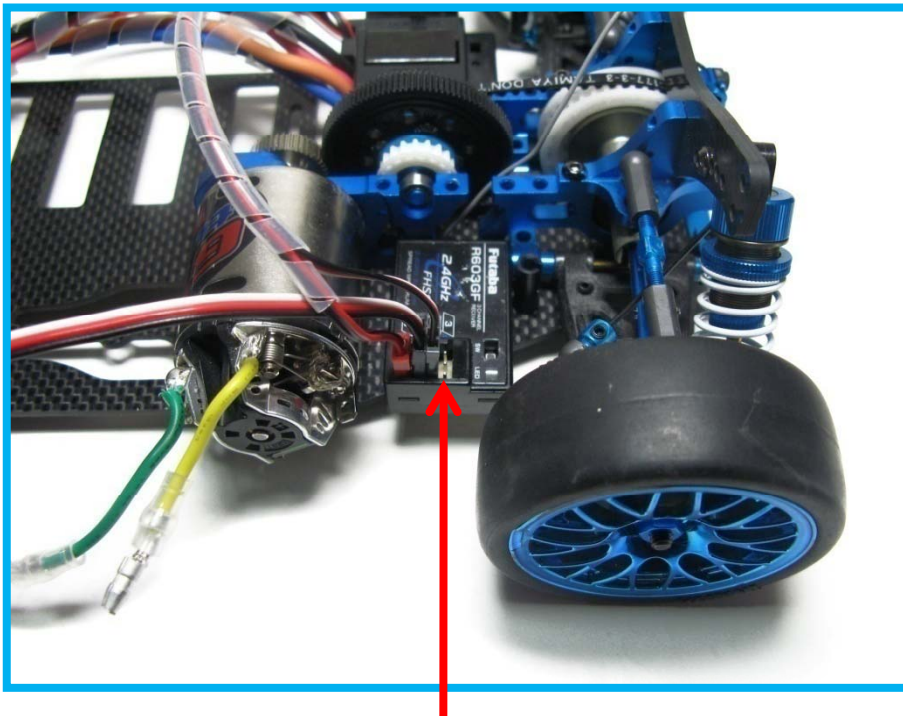

Place black plug from speed controller (O) into socket “2” of receiver (Q)

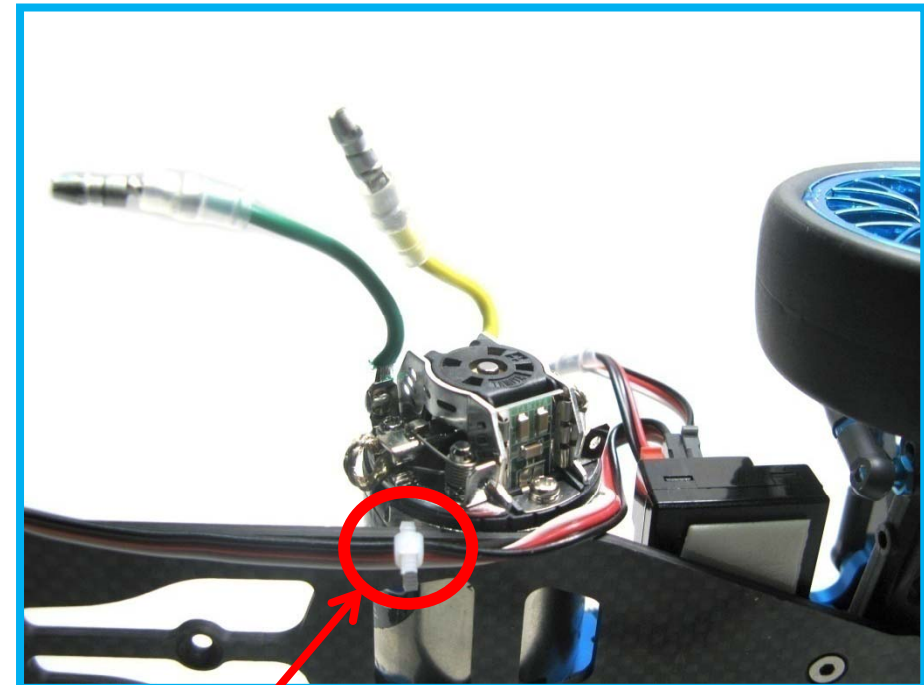

(M)

**STEP 8:** Position the motor heat sink (T) onto the motor (S). Connect speed controller to the motor as below.  
*Ensure the cables are connected correctly.*

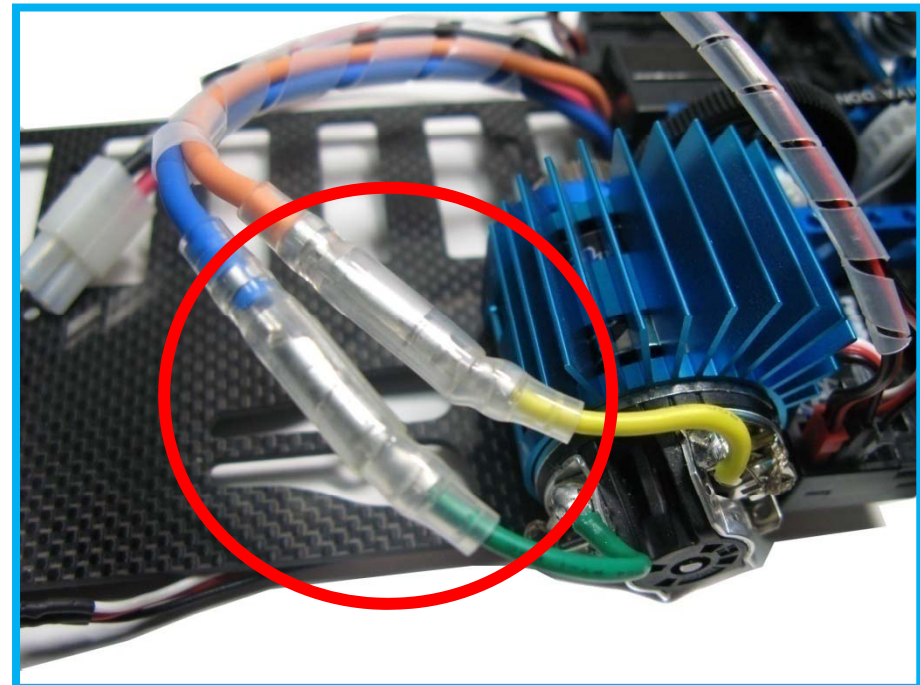
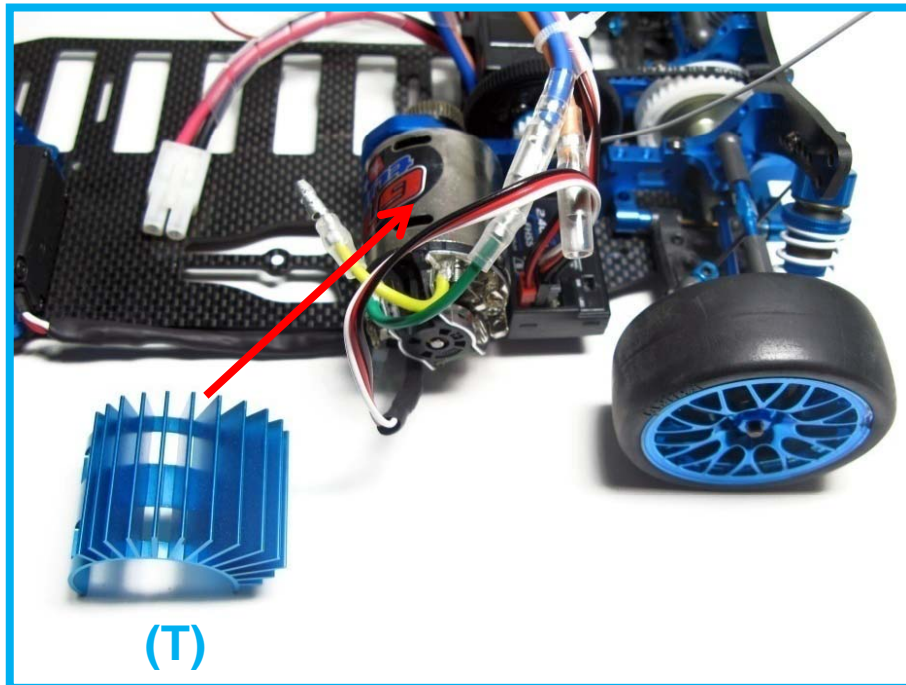

**STEP 9:** Use black double-sided tape to attach the (fully charged) battery (R)\* to the chassis (N) as below.

\*See recommended parts list, [be sure to charge the battery](#) before starting this step.

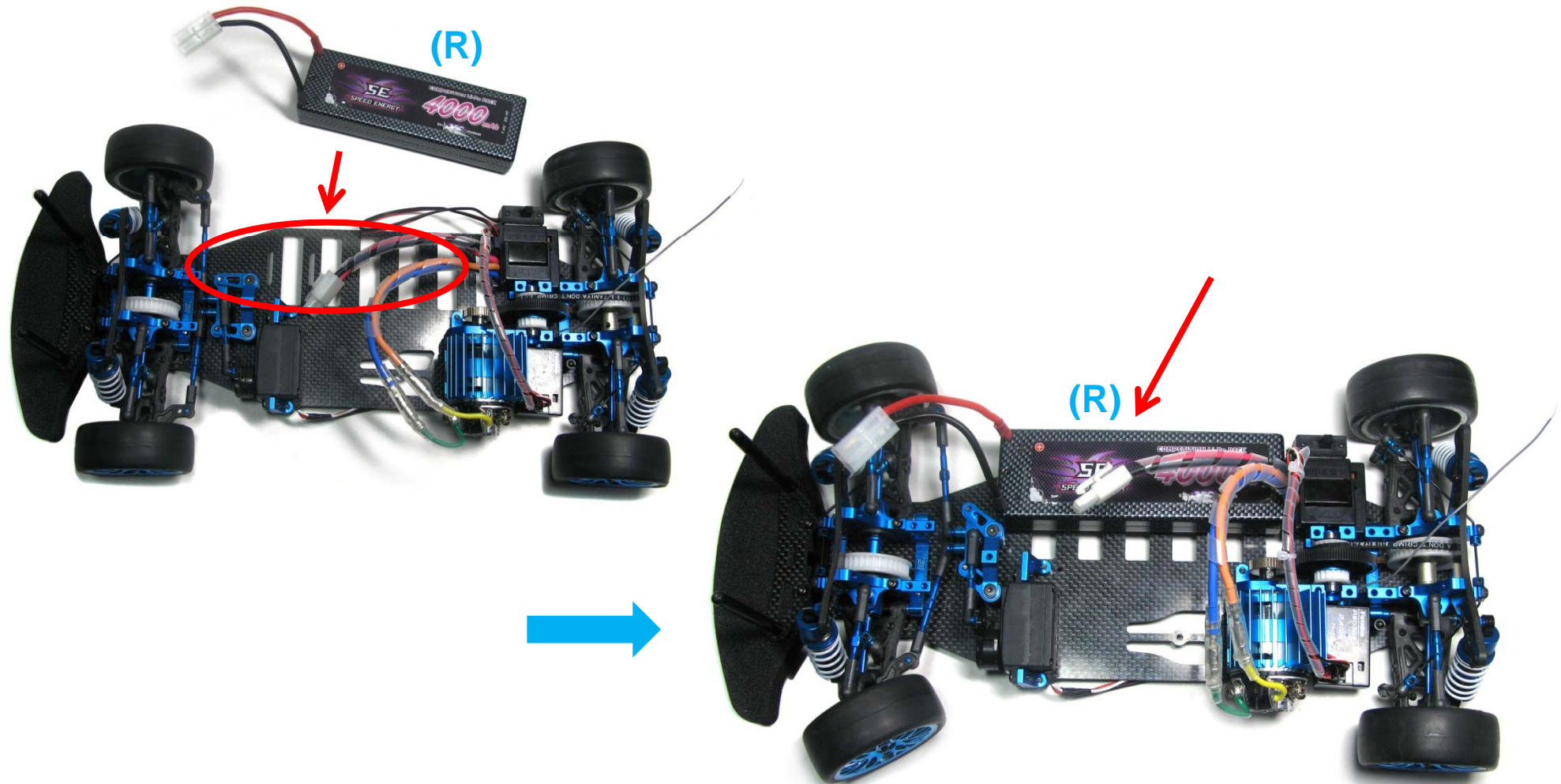

## STEP 10: Assembling the hydrogen fuel cell system

A. Disconnect one end of the tube that connects both gas connection points on the fuel cell (A) as shown below.

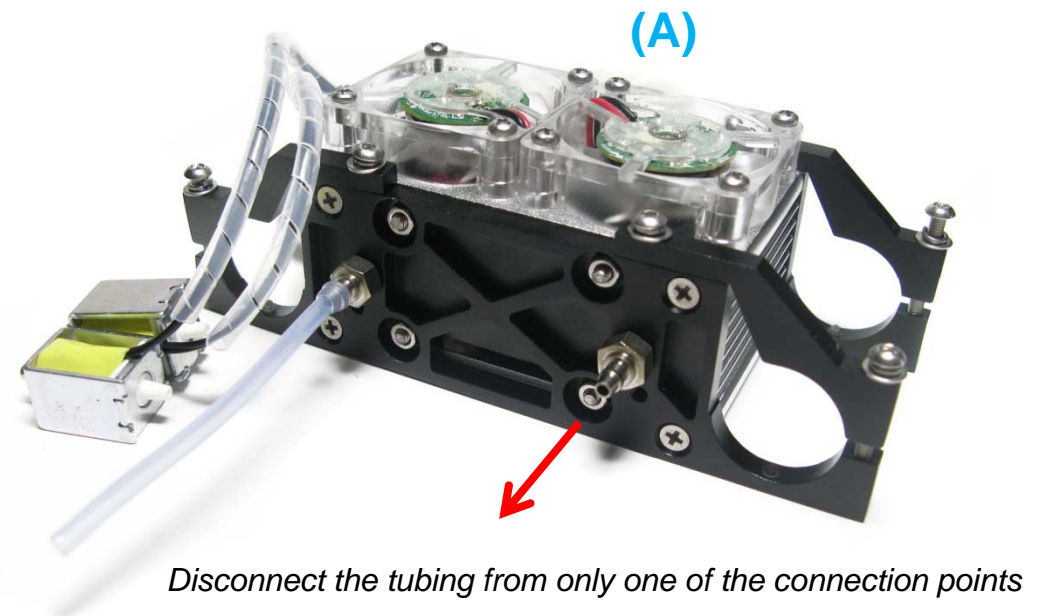
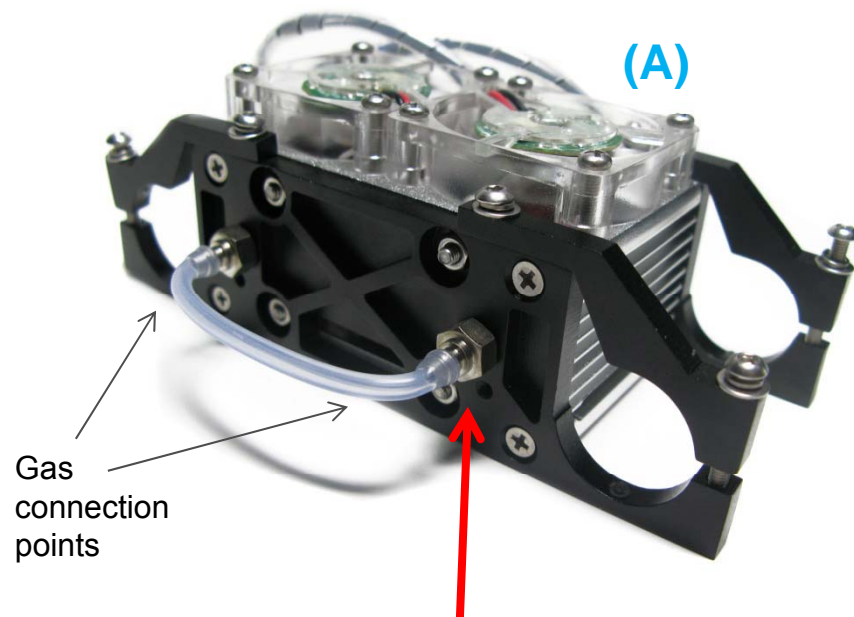

## STEP 10: Assembling the hydrogen fuel cell system

B. Connect a new tubing (G) to the remaining free gas connection point on the fuel cell (A) as shown below.

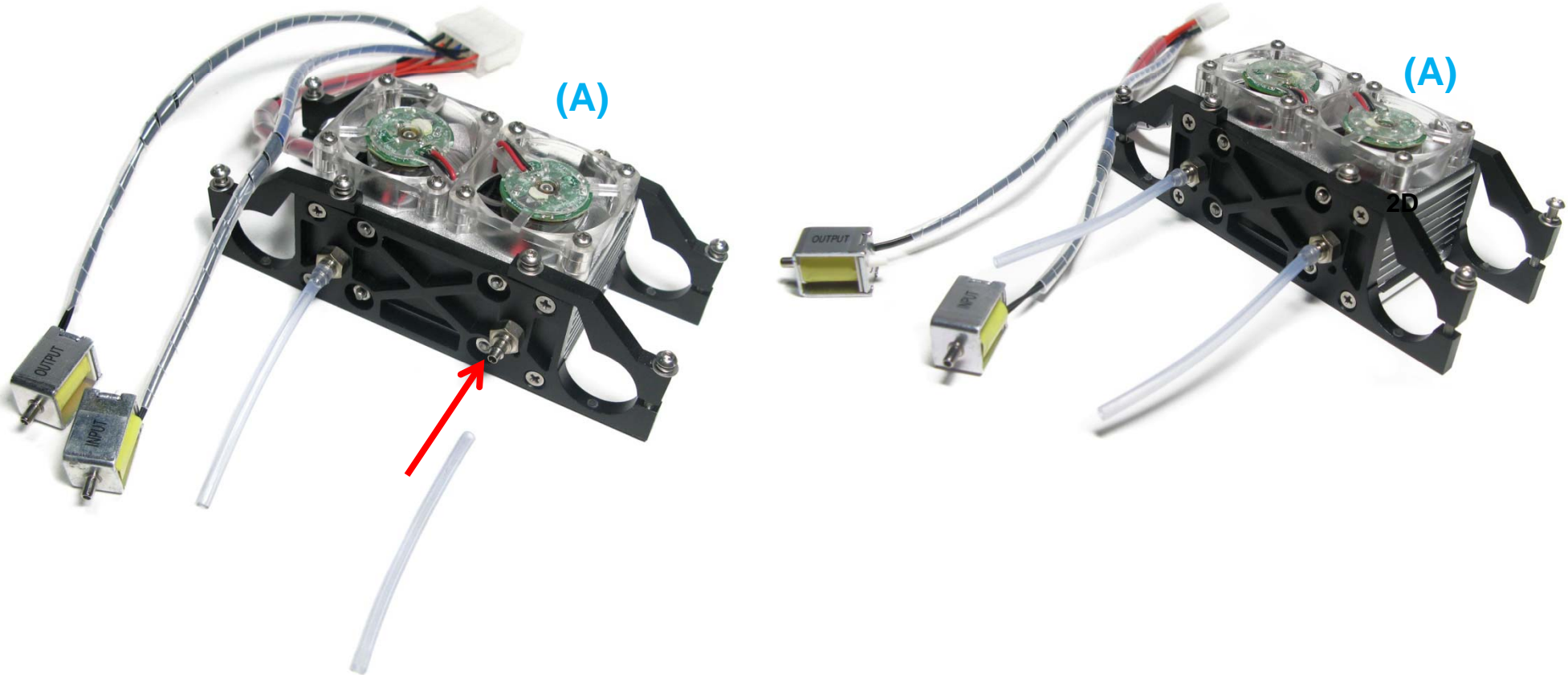



## STEP 10: Assembling the hydrogen fuel cell system

C. Connect each tube to the white plastic connector located on the electronic input and output valves as below.  
Connect the filter(M2) between the fuel cell stack output and the output valve.  
Make sure the small end of the filter is connected to the fuel cell stack output tube.  
Make sure you connect your tubing to the valve's **white plastic connector** and not the metallic one.

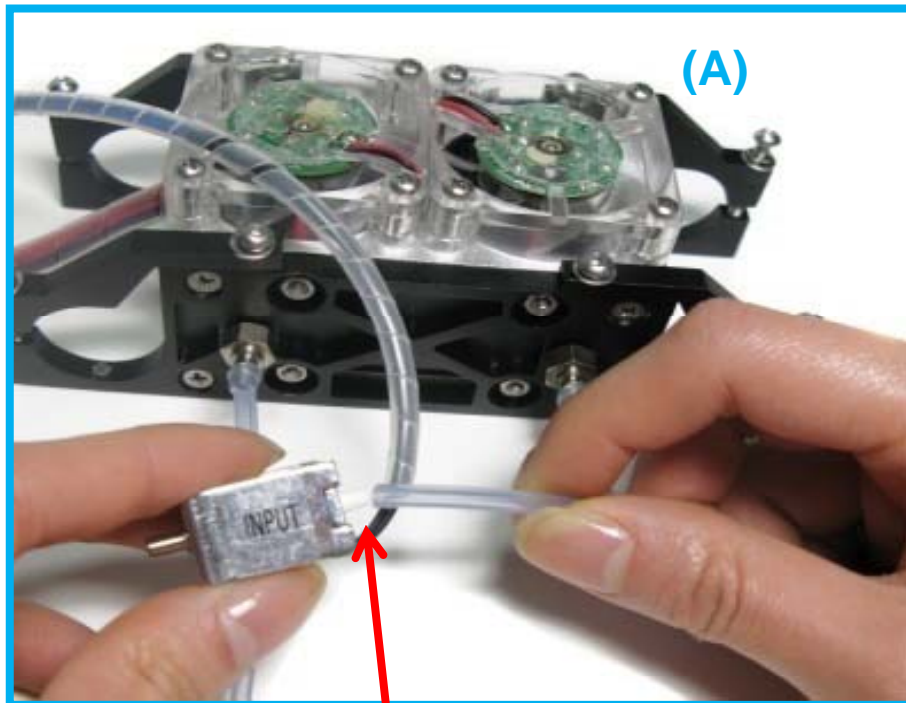

White plastic connector point

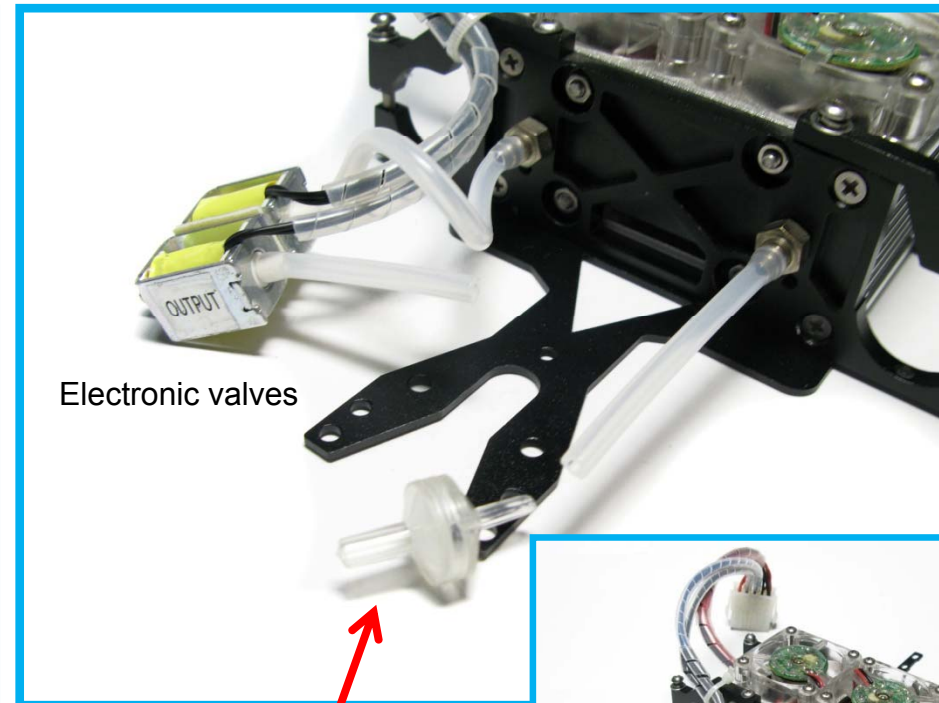

Filter (M2)

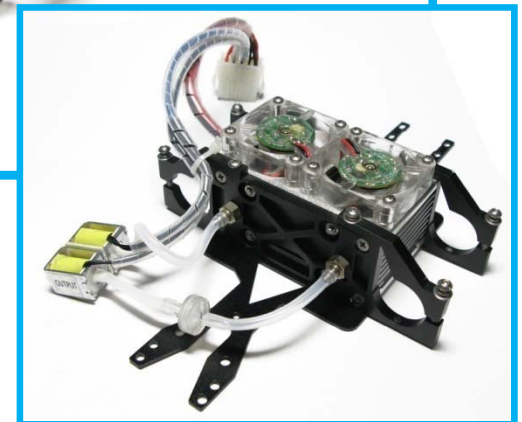

## STEP 10: Assembling the hydrogen fuel cell system

D. Turn the fuel cell (A) upside down and place the aluminum plate (F) exactly as shown below.

Use the spanner to connect the plate to the fuel cell tightly.

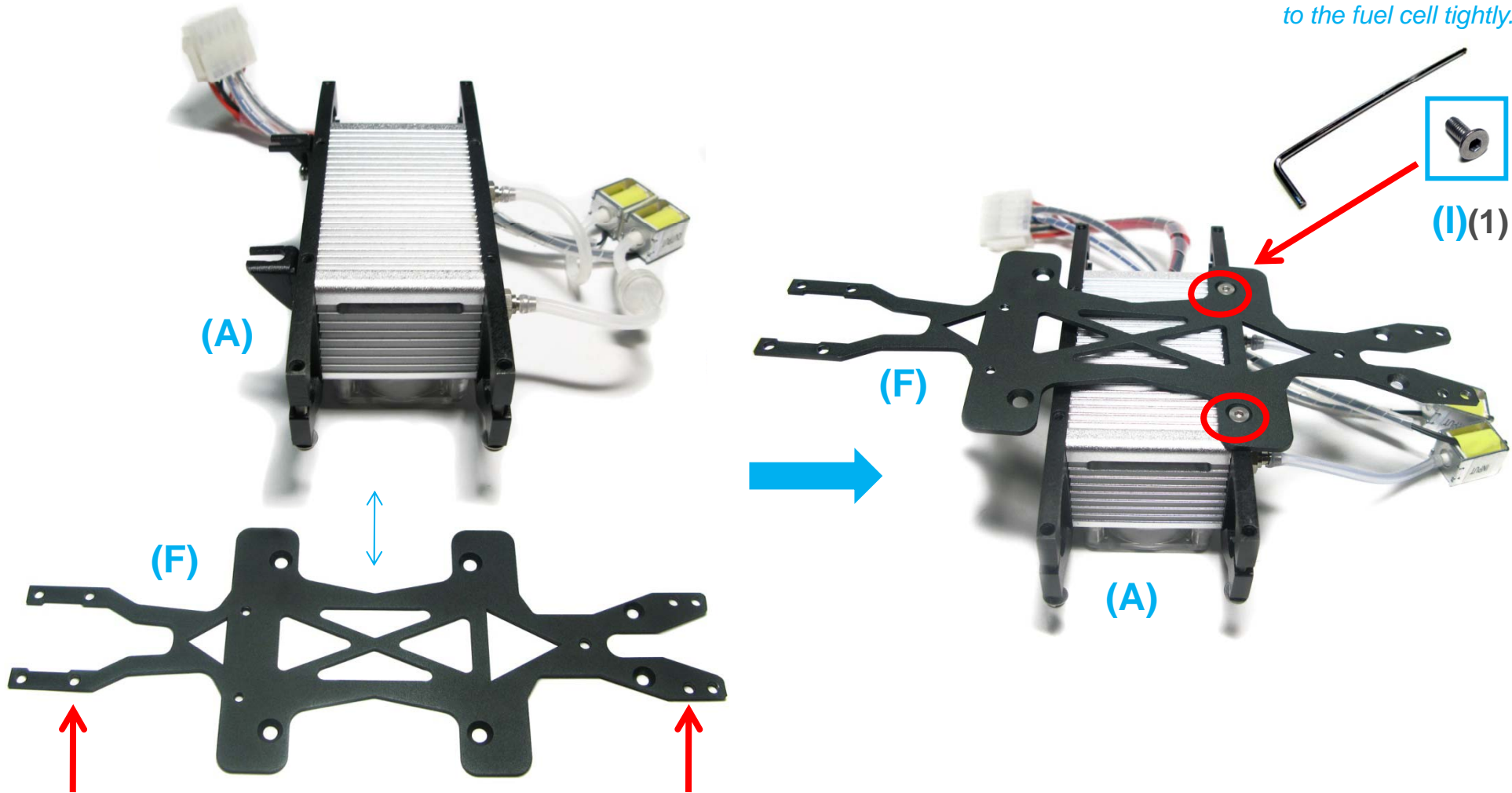

Make sure plate is positioned in the right direction

**STEP 10:** Assembling the hydrogen fuel cell system

E. Use plate connector (L) and screw/washer assembly to connect aluminum plate (F) to the fuel cell (A) as shown below:

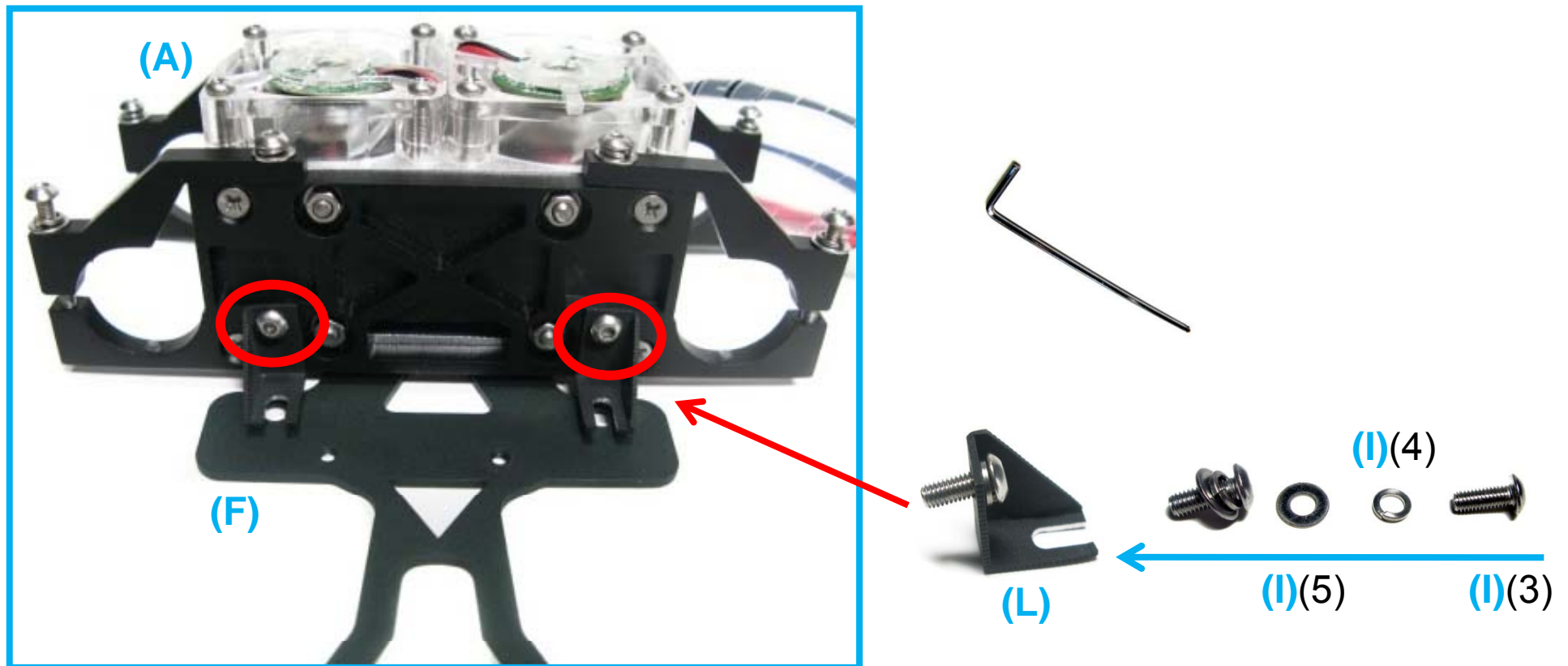

**STEP 10:** Assembling the hydrogen fuel cell system

F. Secure the aluminum plate to the fuel cell. You should obtain the assembly below:

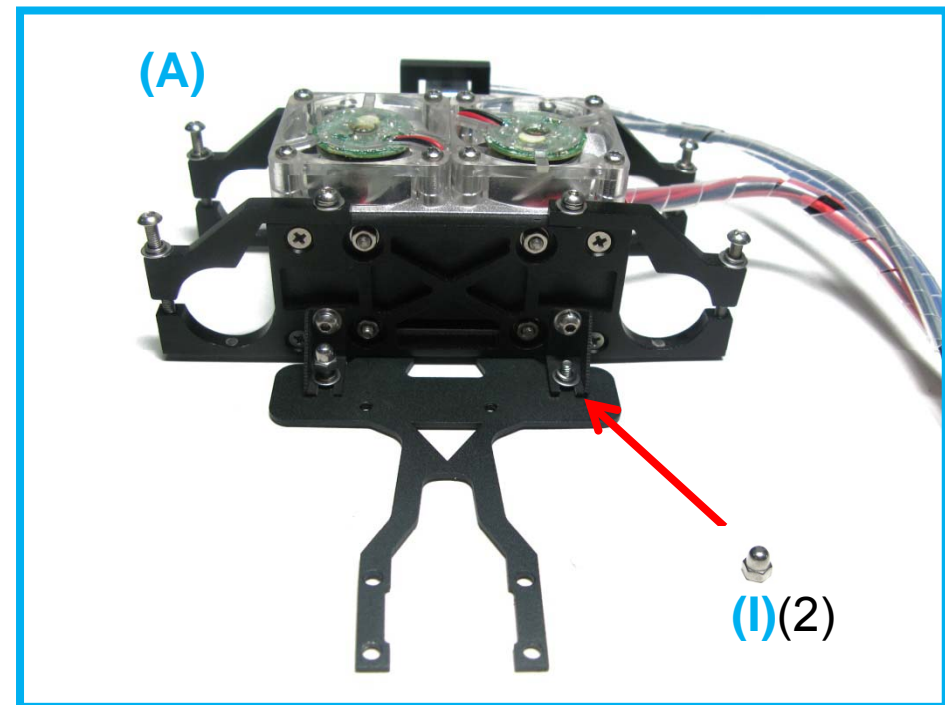
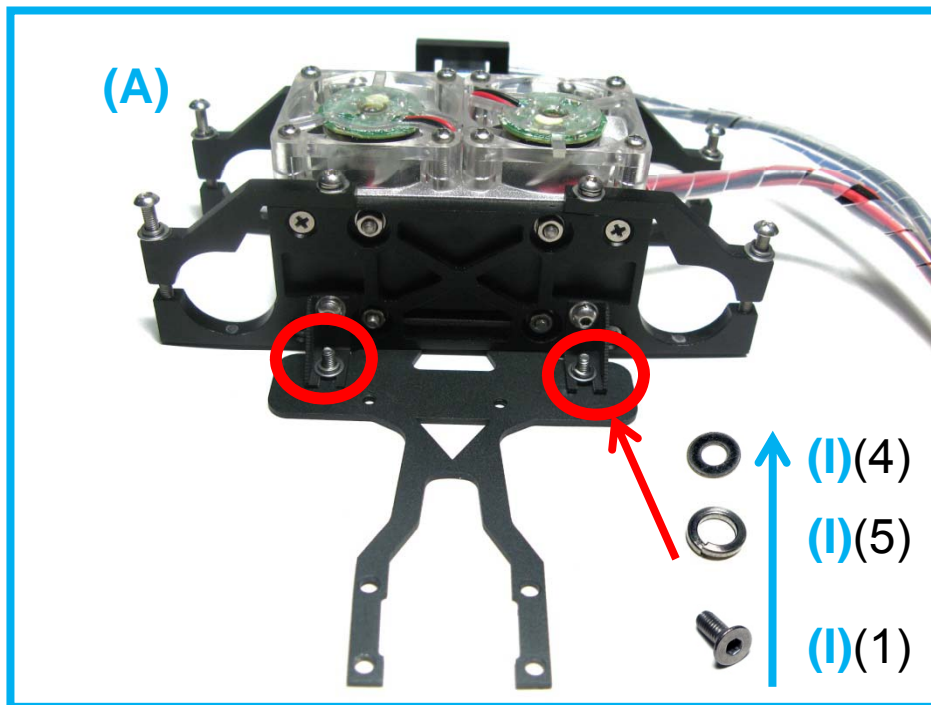

**STEP 10:** *Assembling the hydrogen fuel cell system*

G. *Turn your fuel cell / aluminum support assembly upside down and use your spanner to tighten the nut to the assembly.*

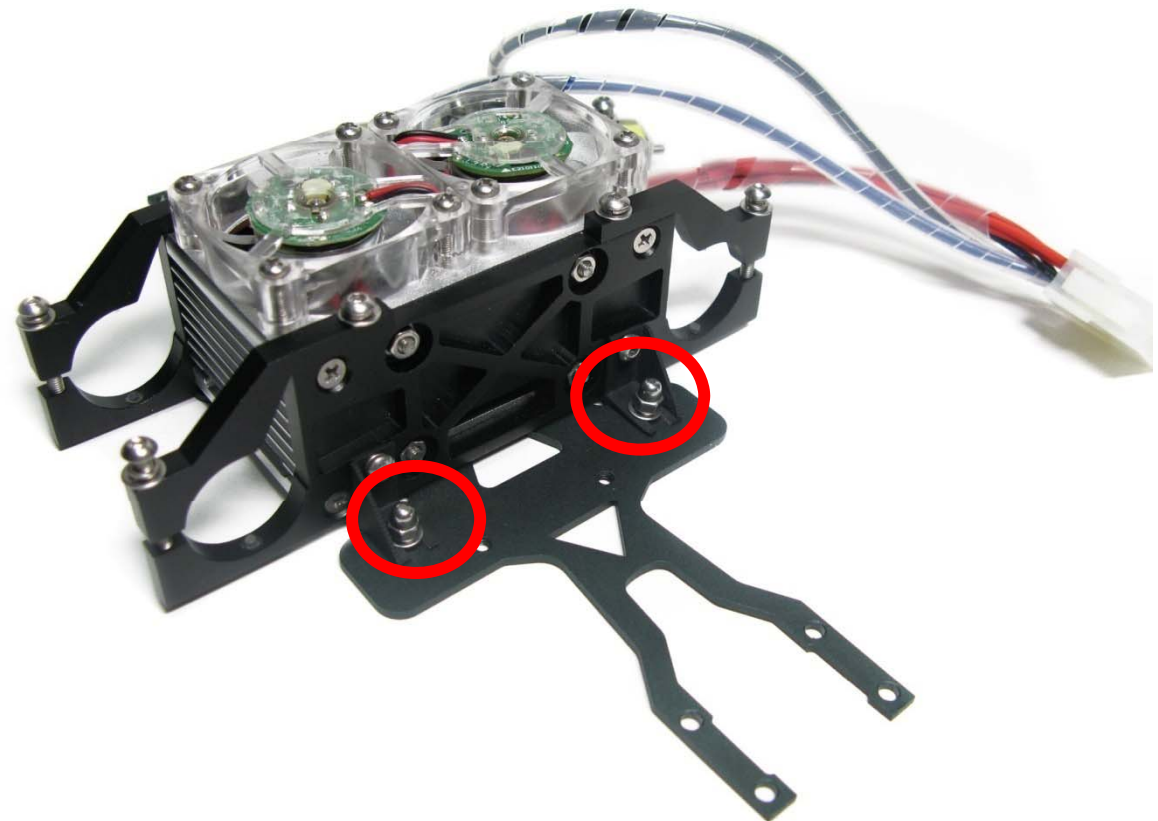
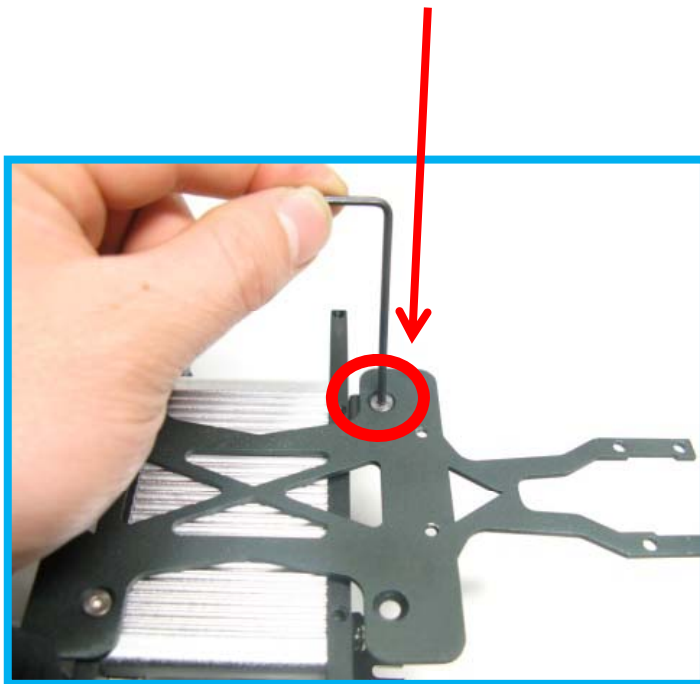

## STEP 10: Assembling the hydrogen fuel cell system

H. Turn your assembly upside down and position the valve holder (D) under the aluminum plate (F) exactly as below. Use the spanner and two screws (I)(1) to connect the valve holder (D) to the aluminum plate (F).

**Note:** Do not tighten the screws yet as you will need to implant the electronic valves into the construction (next step).

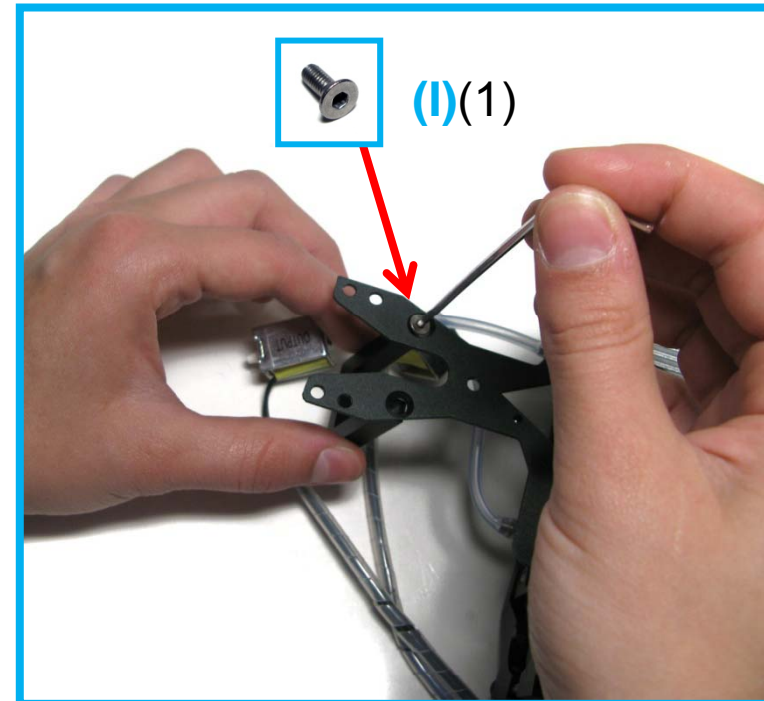
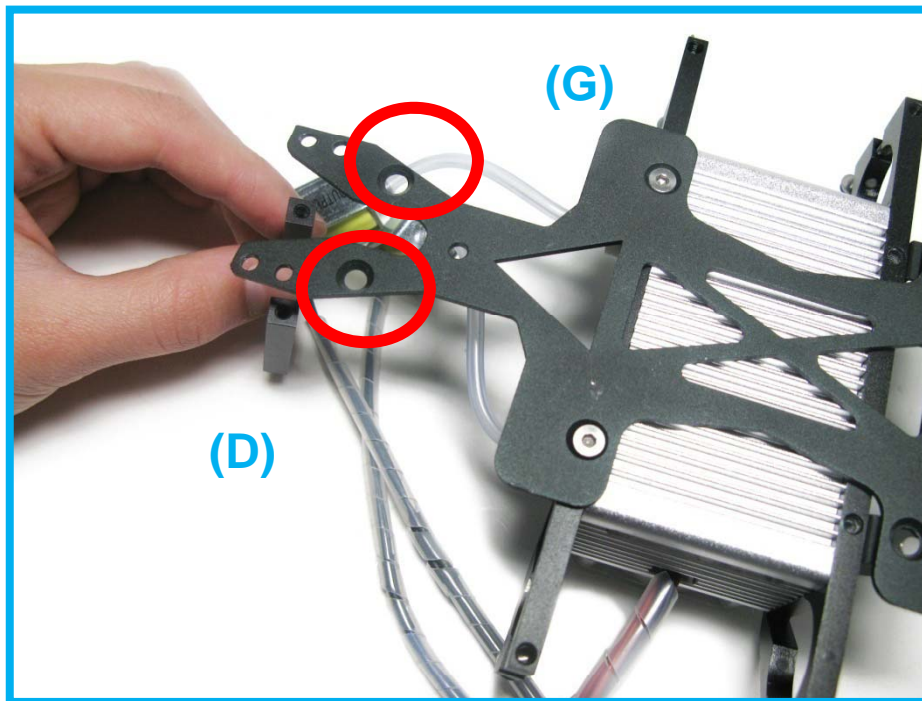

## STEP 10: Assembling the hydrogen fuel cell system

- I. Position the fuel cell's (A) OUTPUT VALVE (see stickers on the valves) on the aluminum plate (F) as below, with the INPUT VALVE positioned below it, into the valve support unit (D).  
Now tighten the screws that connect the valve support unit (D) to the aluminum plate.

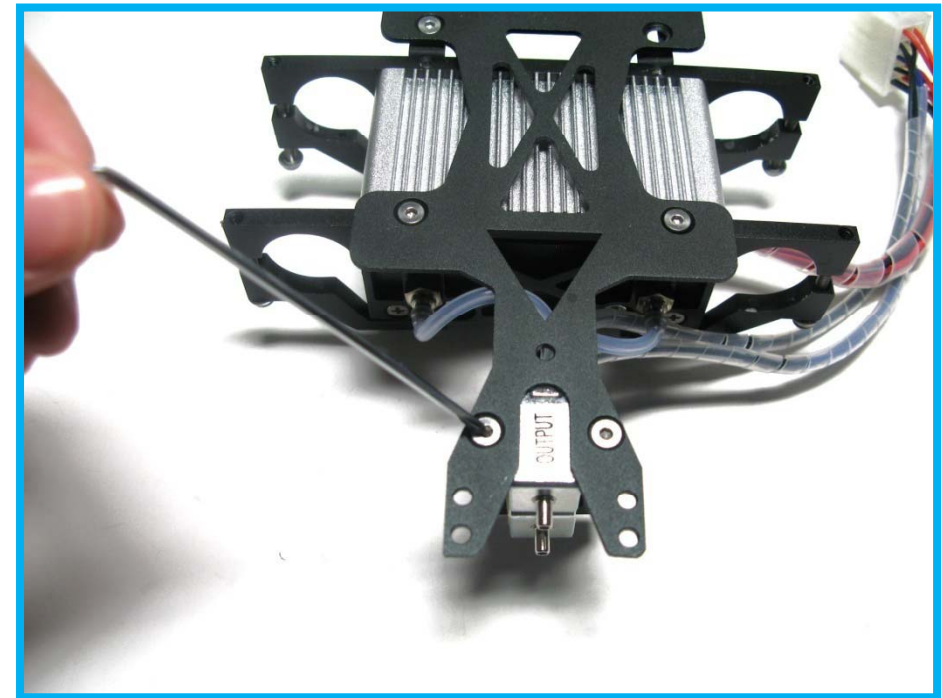
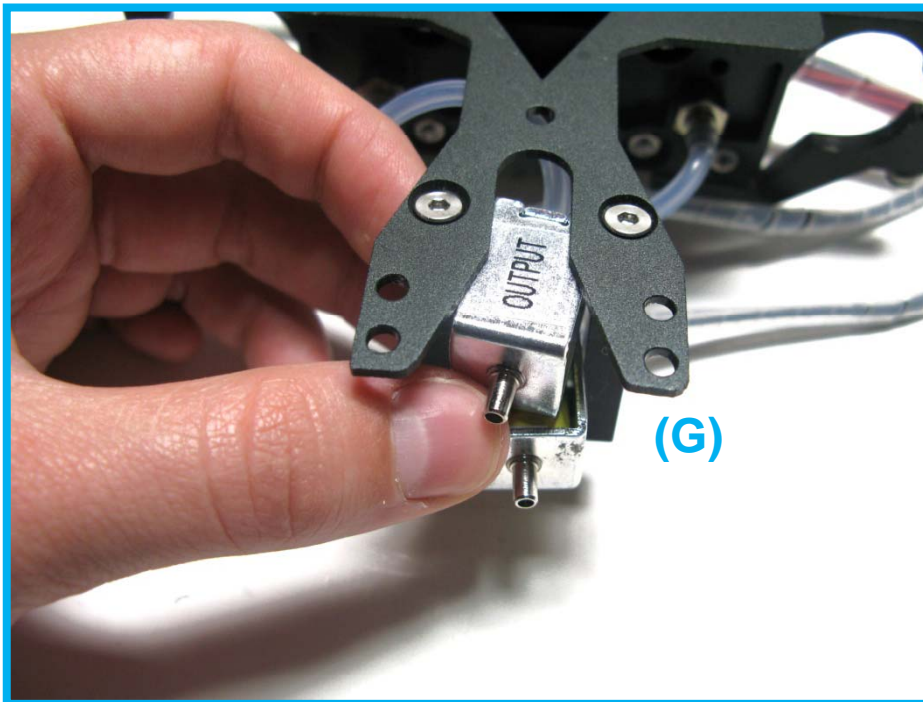

**STEP 11:** Assembling the hydrogen fuel cell system: **COMPLETED!**

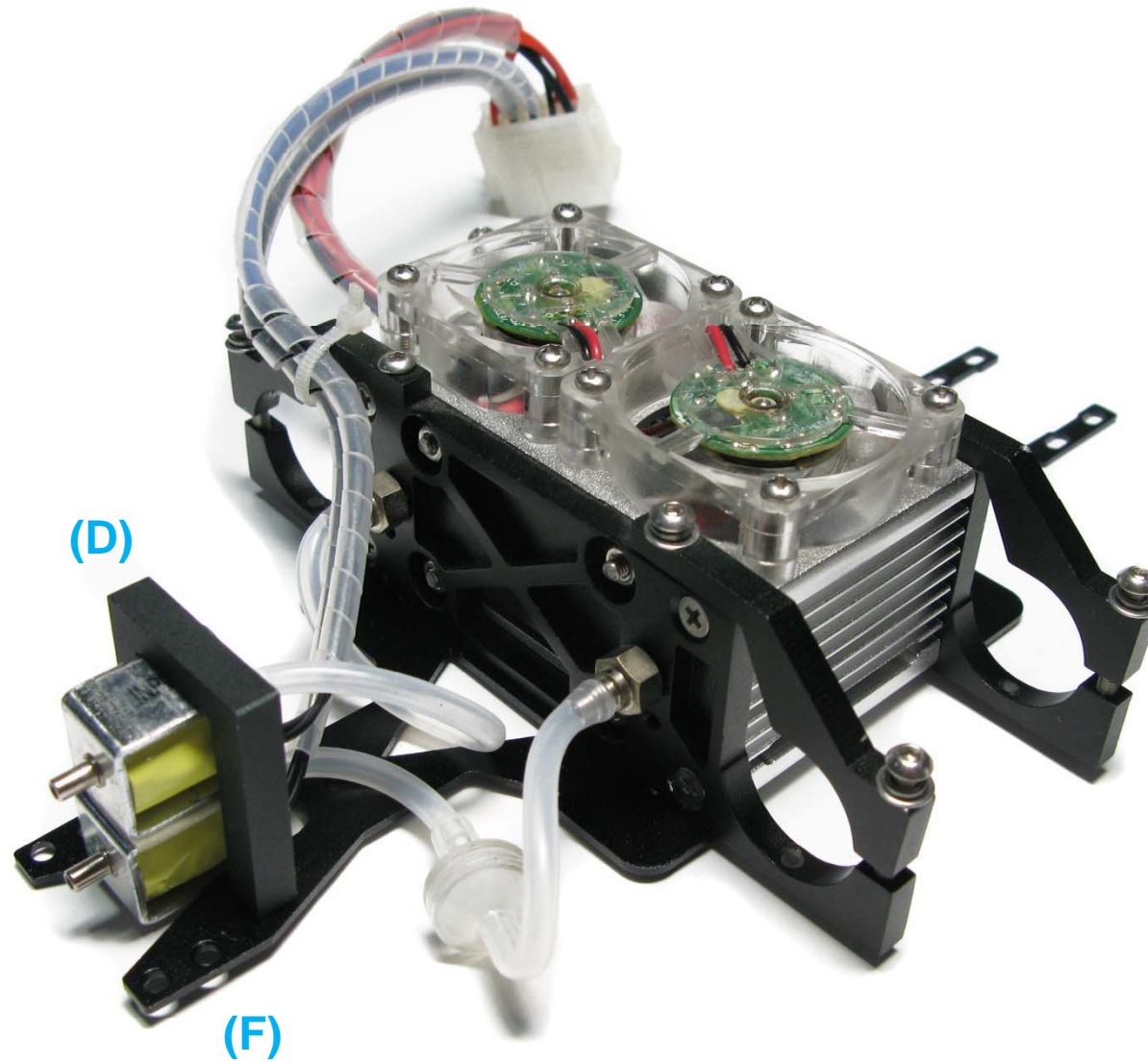

(D)

(F)



**STEP 12:** Connecting the HYDROSTIK hydrogen cartridges to the fuel cell system assembly

A. Connect four silicon rubber tubes (G) to the four-port connector (H) to obtain the assembly below.

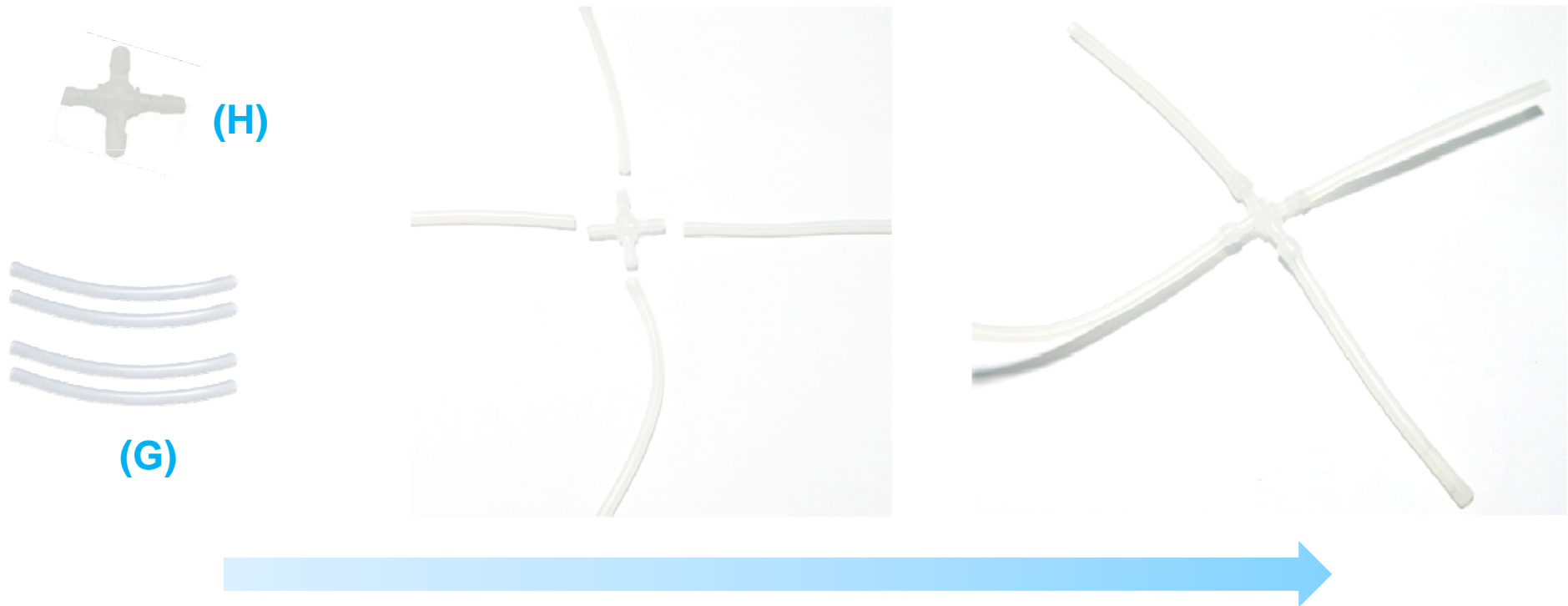

**STEP 12:** Connecting the HYDROSTIK hydrogen cartridges to the fuel cell system assembly

B. Connect two of the four tubes in the previous assembly to the two pressure regulators (B) as shown below.

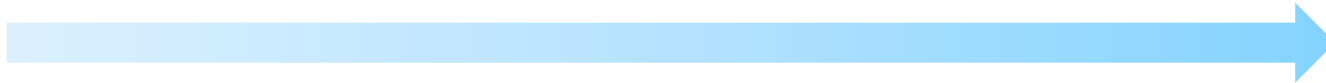
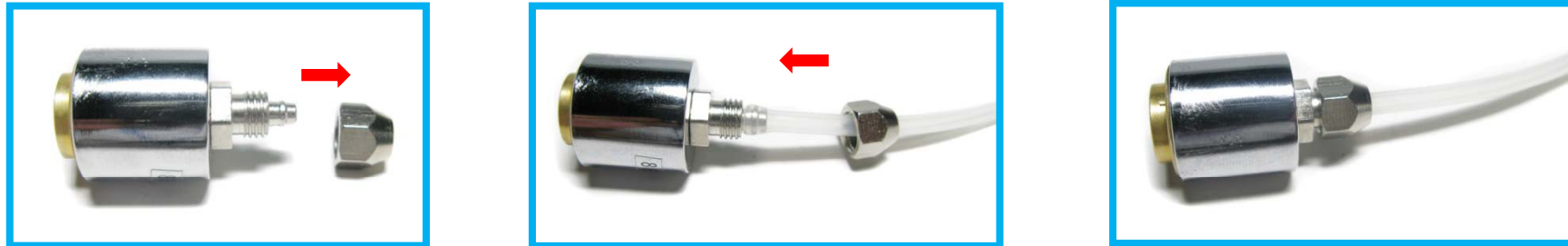

**(B)**



**STEP 12:** Connecting the HYDROSTIK hydrogen cartridges to the fuel cell system assembly

C. Connect one remaining tube to the input valve (located on top) of the fuel cell system assembly.

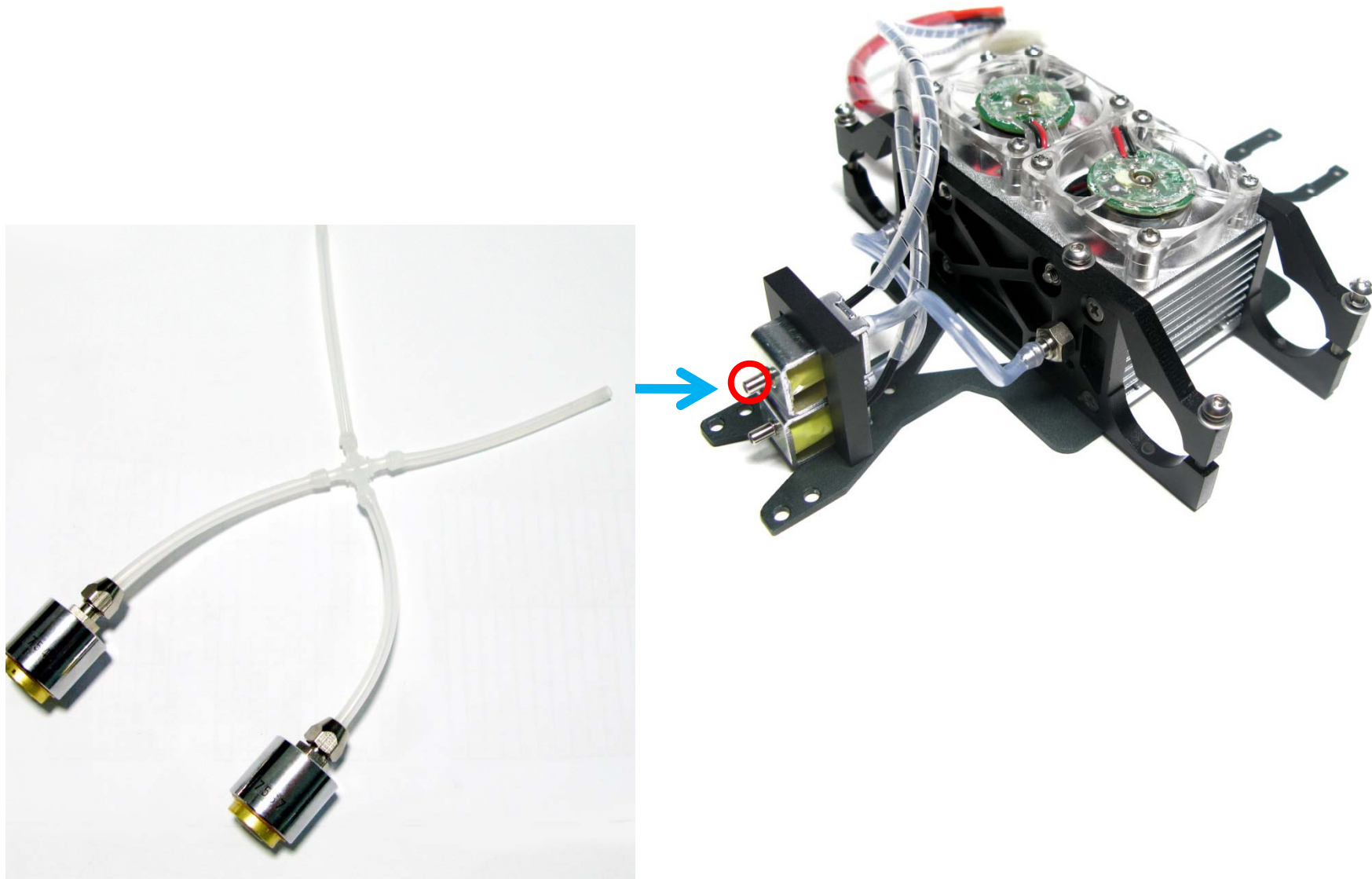

## STEP 12: Connecting the HYDROSTIK hydrogen cartridges to the fuel cell system assembly

D. Connect the **(fully charged)** HYDROSTIK PRO cartridges (C) to both pressure regulators (B).

**Make sure to screw-in the canisters tightly when in use and be sure to disconnect them after use.**

**Note:**

1. Only use the canisters provided in the H-cell packaging.
2. Screw in the canisters quickly to avoid hydrogen gas release.



**STEP 12:** Connecting the HYDROSTIK hydrogen cartridges to the fuel cell system assembly

E. Position both HYDROSTIK PRO cartridges (C) onto both canister support units on the system. Use the screw driver to tighten.

**Note:** Before position both HYDROSTIK PRO cartridges (C) onto both canister support units, place a piece of silicon sheet (M1) on the support unit to protect the canister.

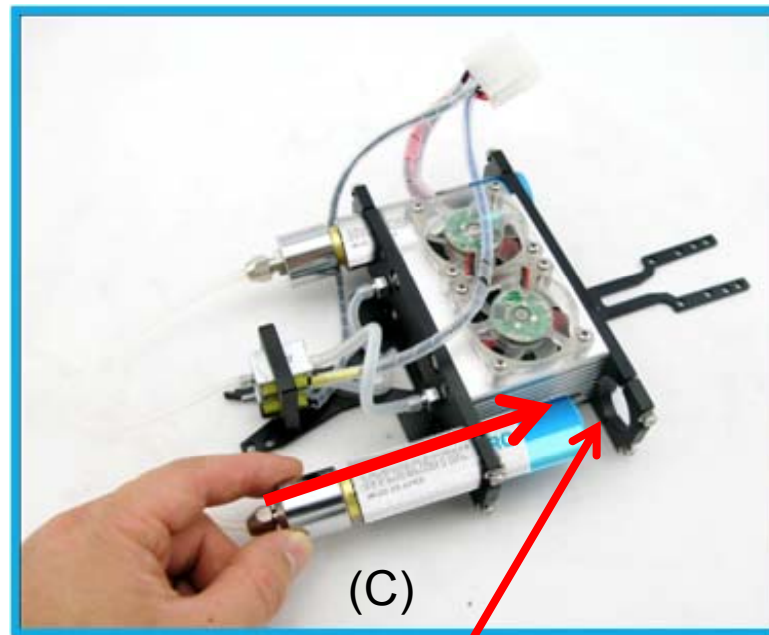

**STEP 13:** Connecting the electronic control box to the fuel cell system assembly

A. Remove cover from the electronic control box (E).

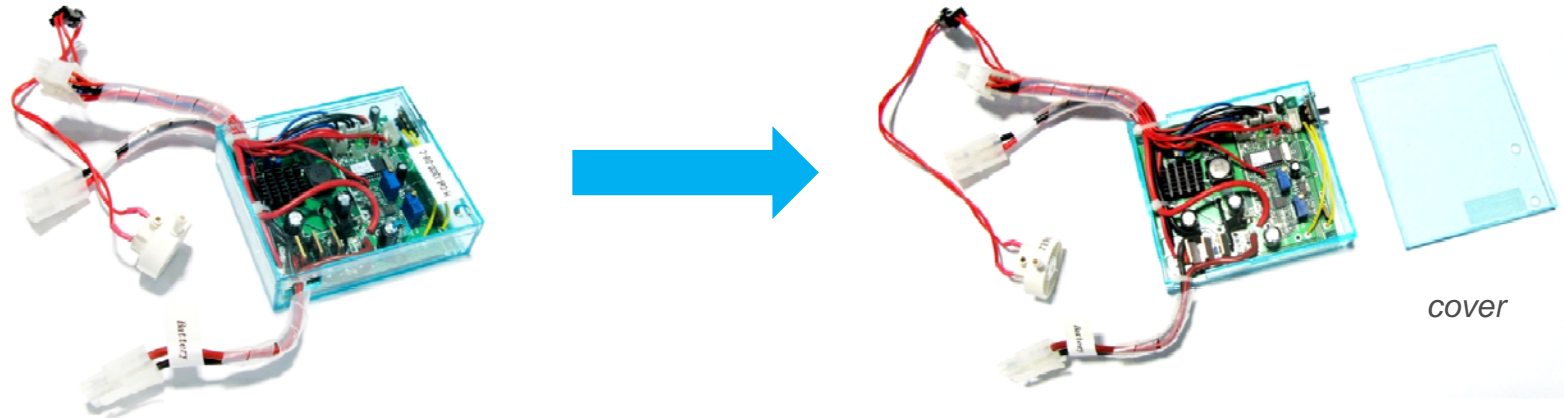

**System controller LED Indicator**

<b>Starting up Period</b>	
<b>Controller LED Indicator</b>	<b>Status</b>
Red LED flashes & Green LED off	Lithium battery voltage <6V
Red LED lights & Green LED off	Fuel cell stack voltage <8.4V
Red LED flashes & Green LED lights	Lithium battery voltage <7V
Red LED off & Green LED lights	Normal Starting up
<b>Operating Period</b>	
<b>Controller LED Indicator</b>	<b>Status</b>
Red LED lights & Green LED off	Fuel cell stack voltage ≤6.7V
Red LED flashes & Green LED flashes	Lithium battery voltage ≤6V
Red LED lights & Green LED flashes	Fuel cell stack temperature ≥65C
Red LED off & Green LED flashes	Hydrogen pressure is too low, the load is cut off automatically
Red LED off & Green LED lights	Normal operating

**STEP 13:** Connecting the electronic control box to the fuel cell system assembly

B. Turn the fuel cell system assembly upside down, and place the electronic control box COVER on the aluminum support plate, aligning the screw holes as below. Use the spanner and two screws (I)(1) to connect the box cover to the aluminum support plate (F).

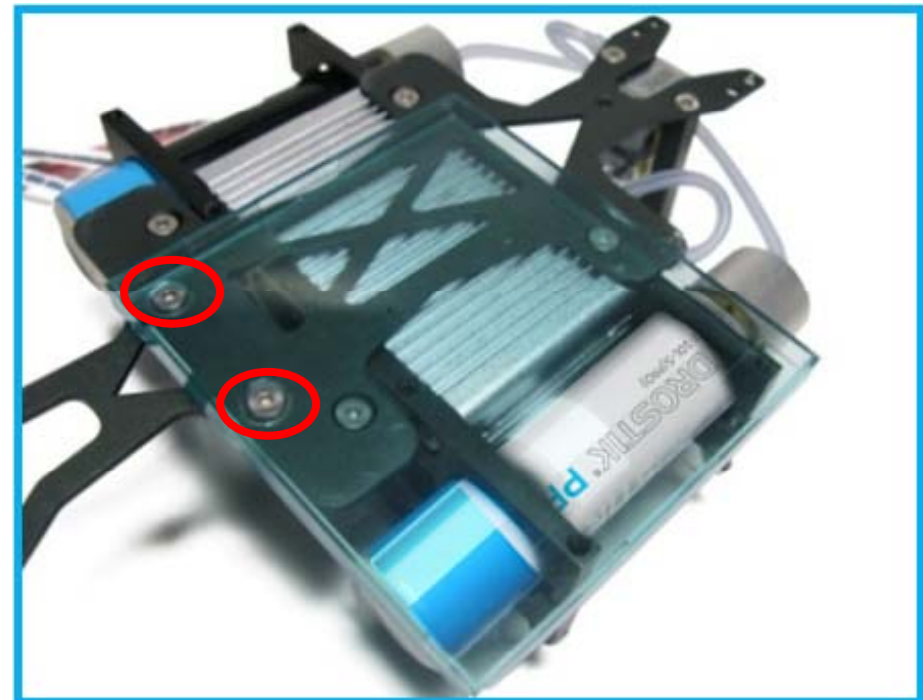
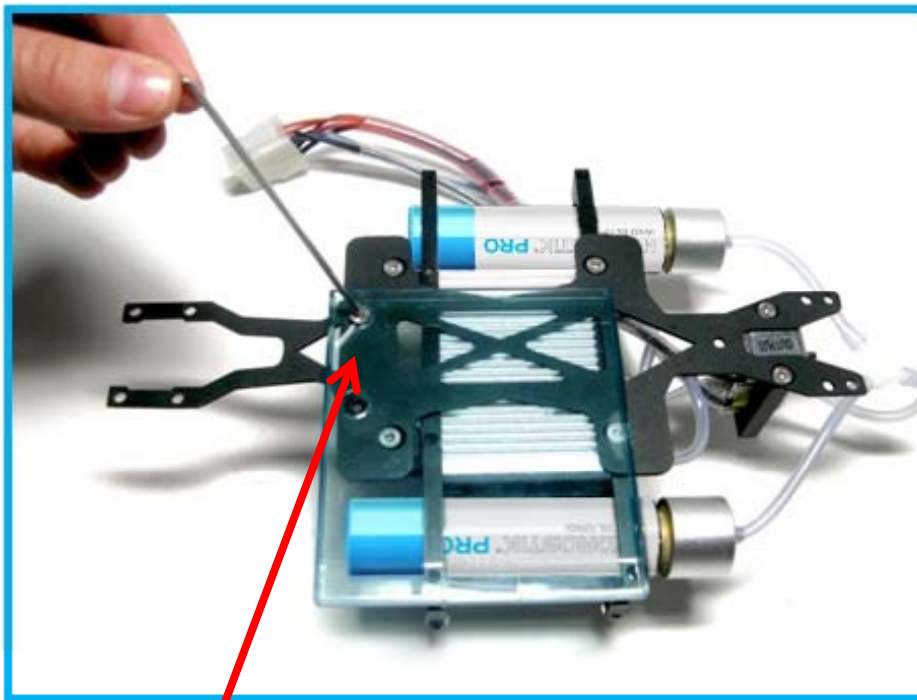

(I)(1)

### STEP 13: Connecting the electronic control box to the fuel cell system assembly

C. Place the electronic box (E) over its cover and press down to connect to the rest of the fuel cell system assembly. Make sure the pressure switch is connected to the four connecting port.

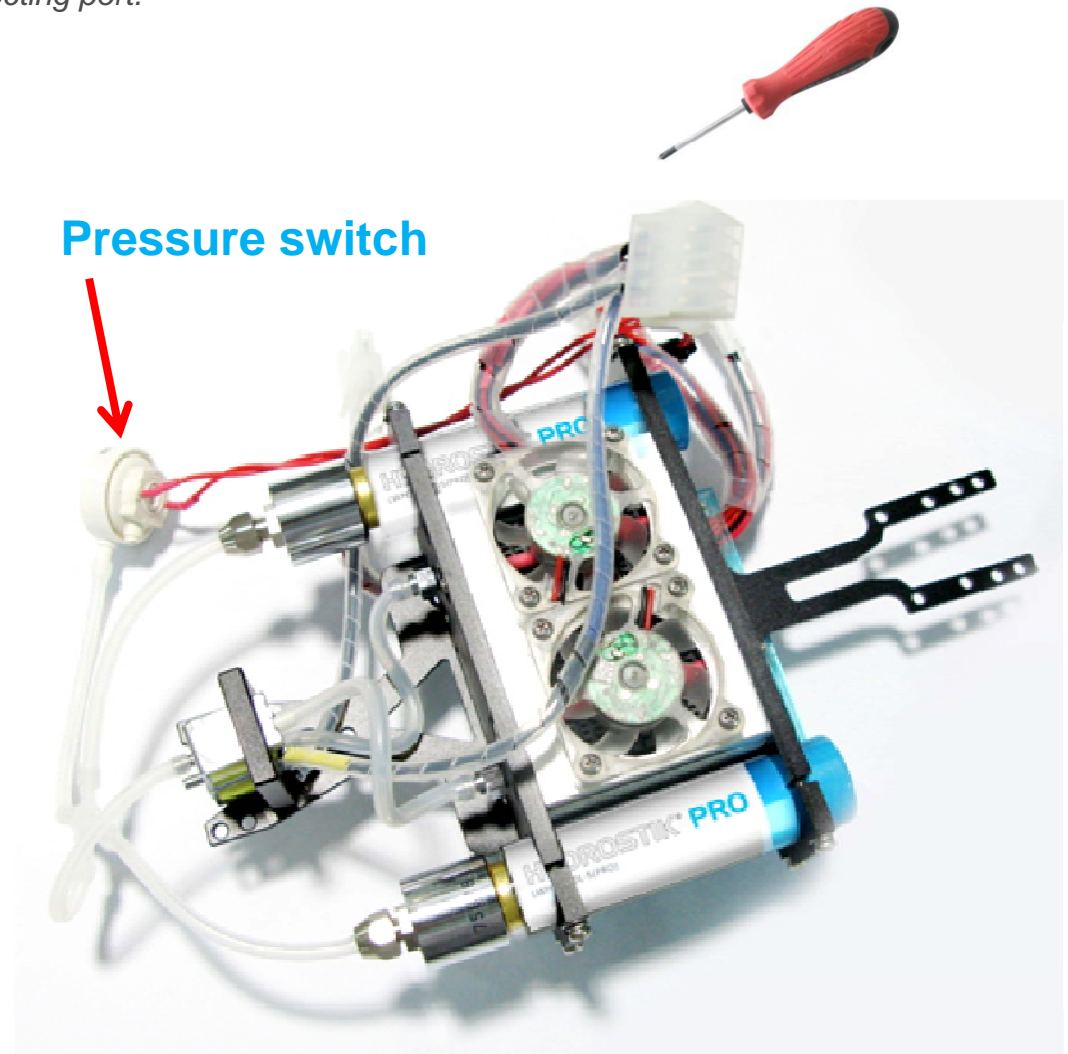
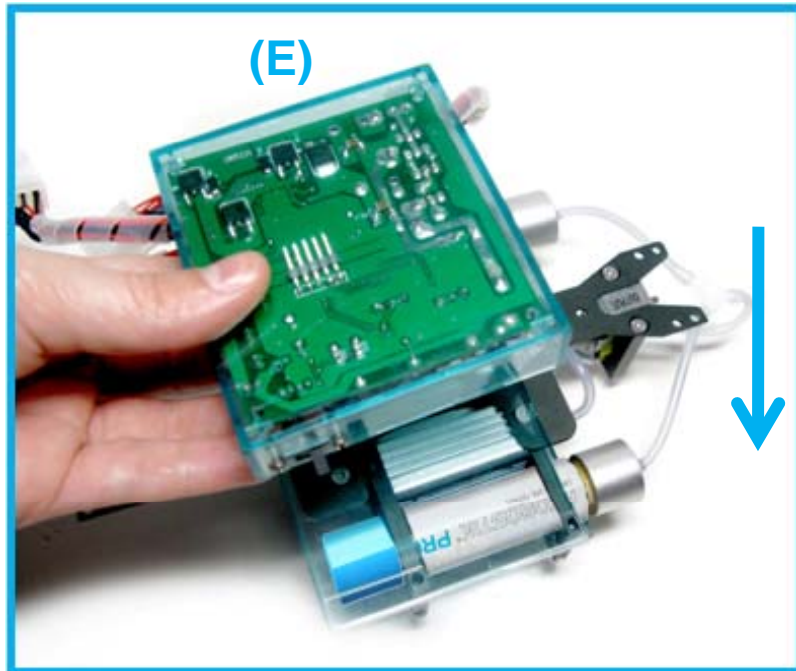



**STEP 14:** Connecting the fuel cell system to the modified vehicle chassis (see step 1)

- A. Position the fuel cell system assembly onto the chassis as below, carefully aligning the screw connection points. Use [the spanner and screws \(1\)\(5\)](#) to connect the support plate to the chassis.

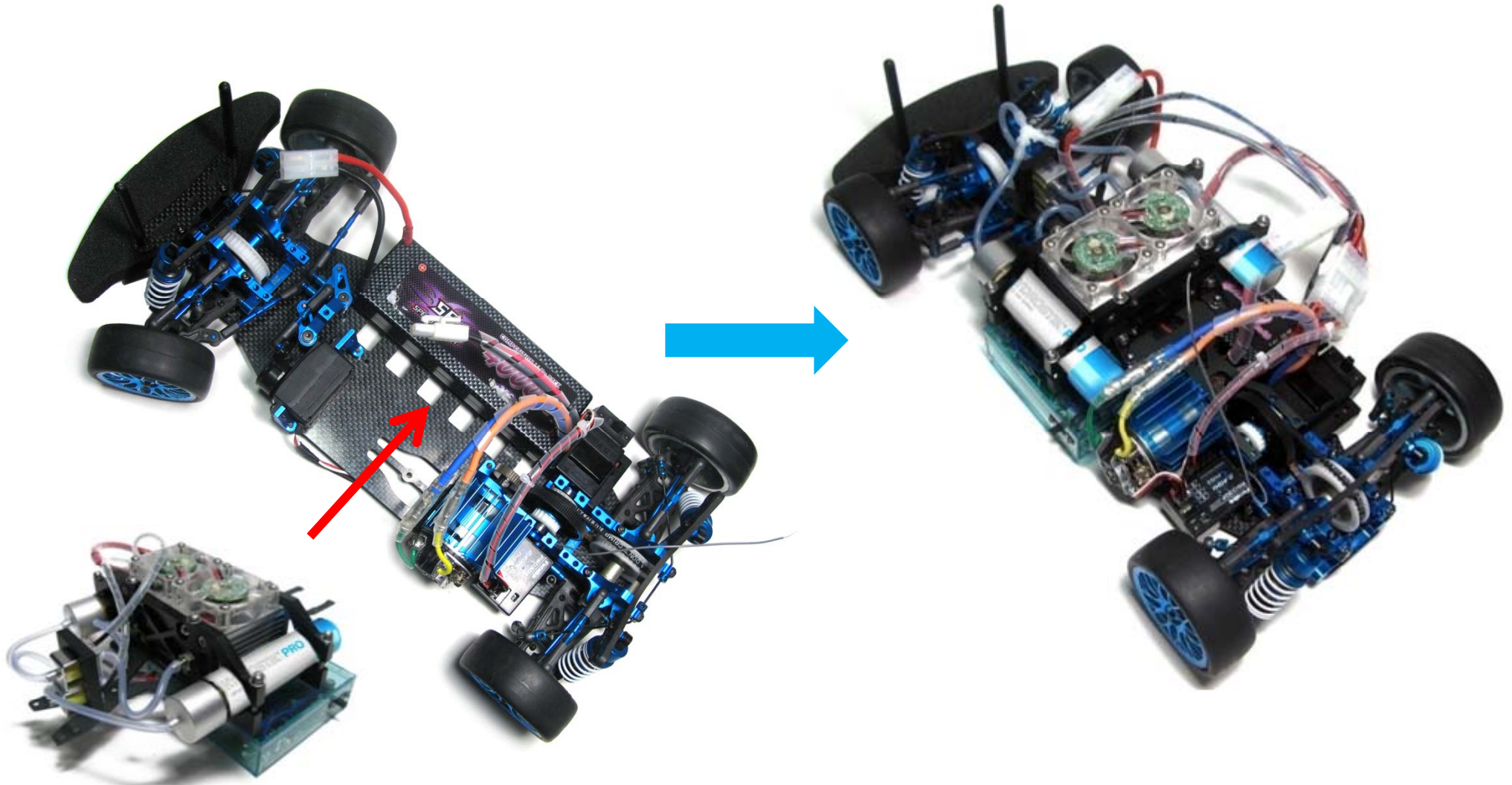

**STEP 14:** Connecting the fuel cell system to the modified vehicle chassis (see step 1)

B. Connect back section of the aluminum support plate (F) to the chassis (N) as below.

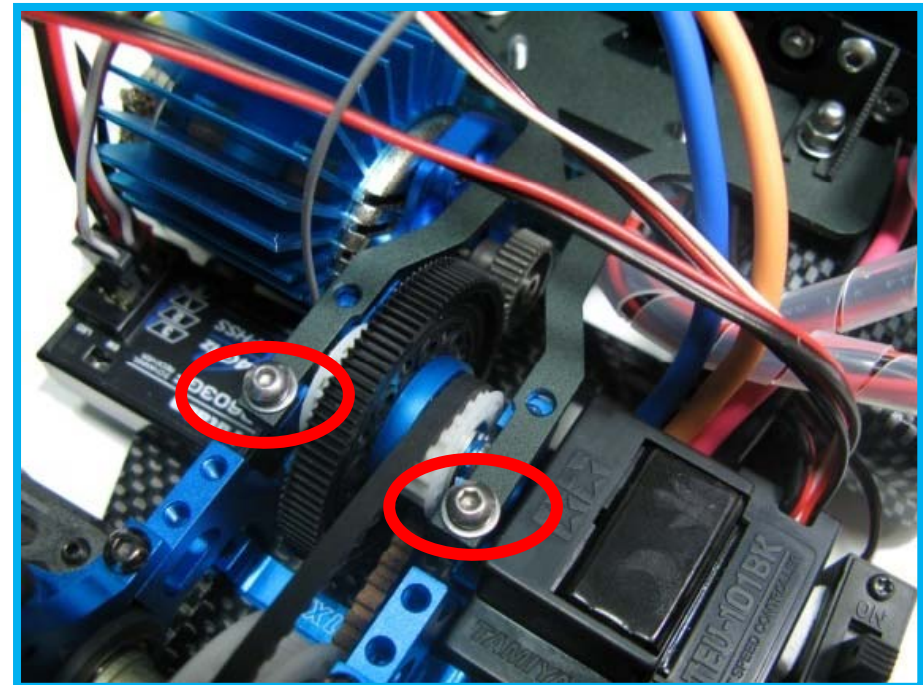
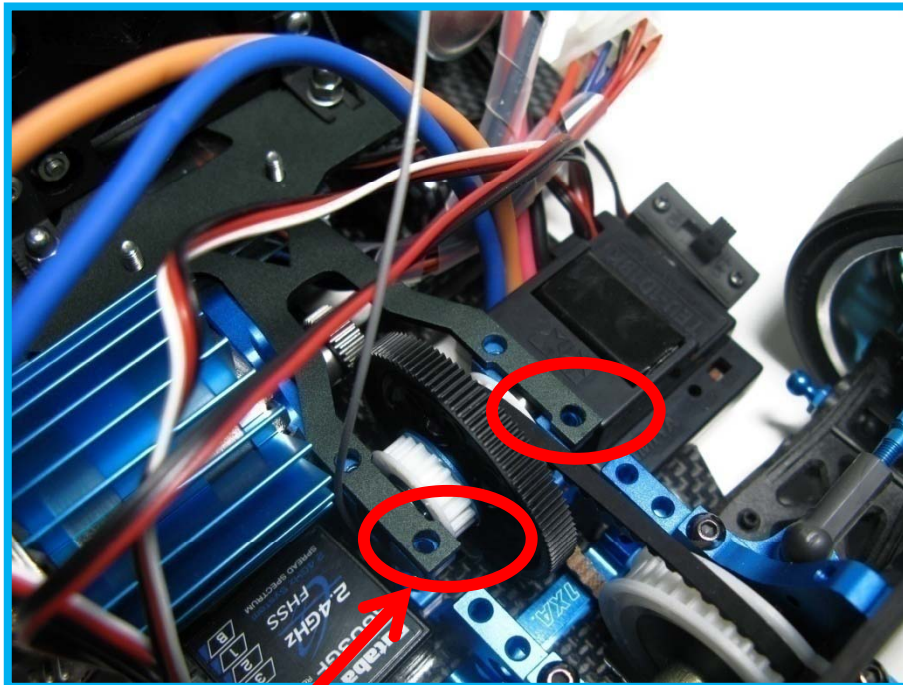

(I)(3,4)



**STEP 14:** Connecting the fuel cell system to the modified vehicle chassis (see step 1)

C. Connect front section of the aluminum support plate (F) to the chassis (N) as below.

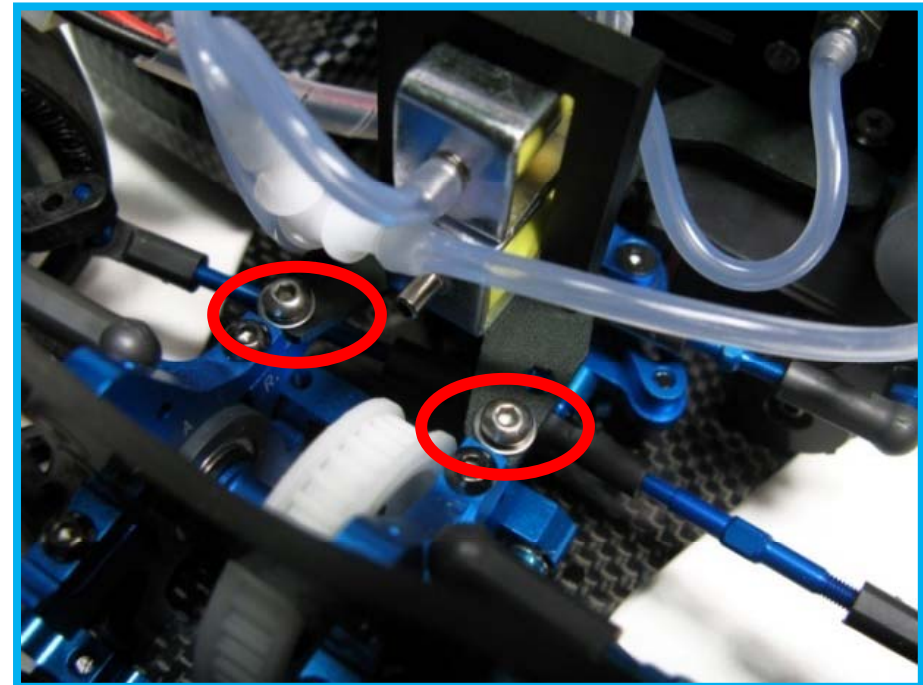
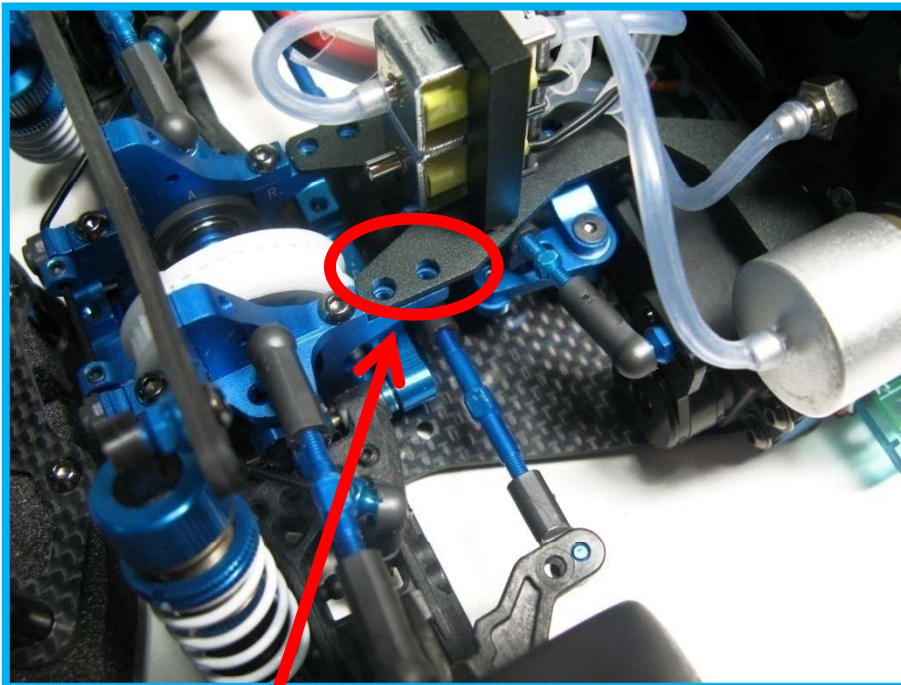

(I)(3,4)



## STEP 15: Electronic connections

A. Connect the fuel cell (A) to electronic control box (E).

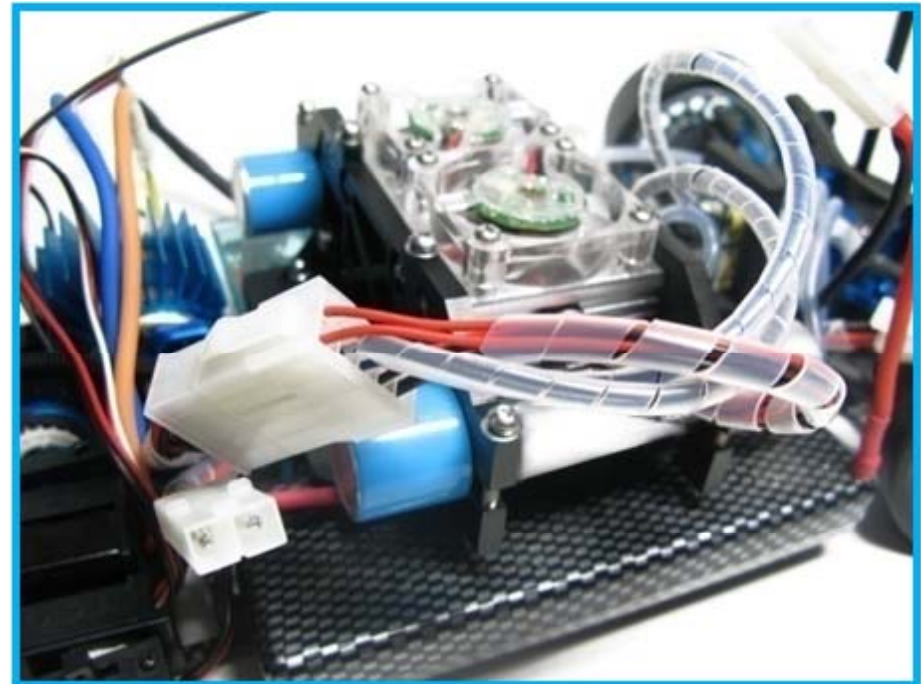
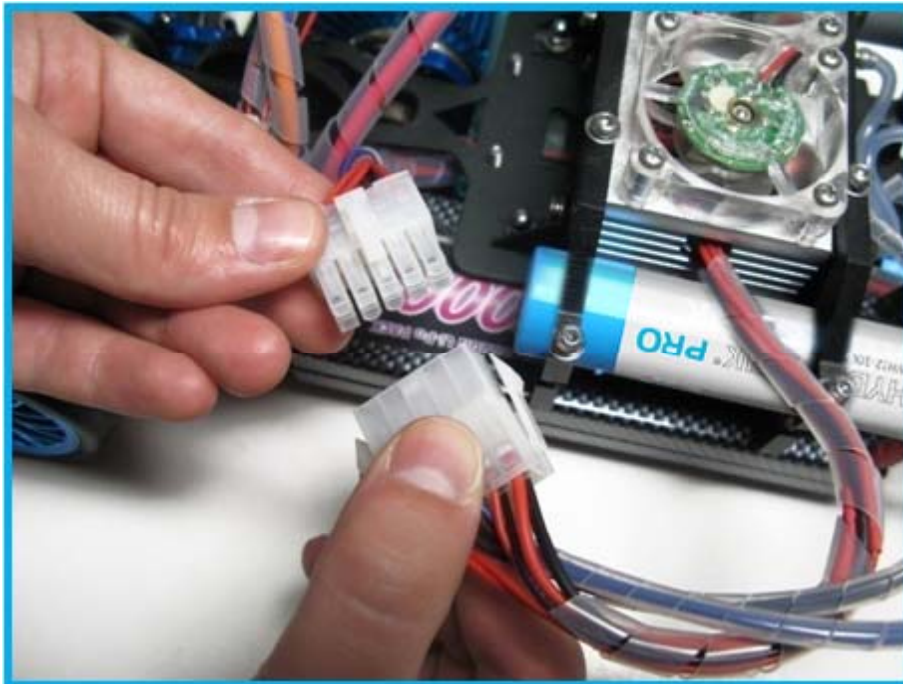

## STEP 15: Electronic connections

B. Connect the electronic controller (A) to the motor (R).

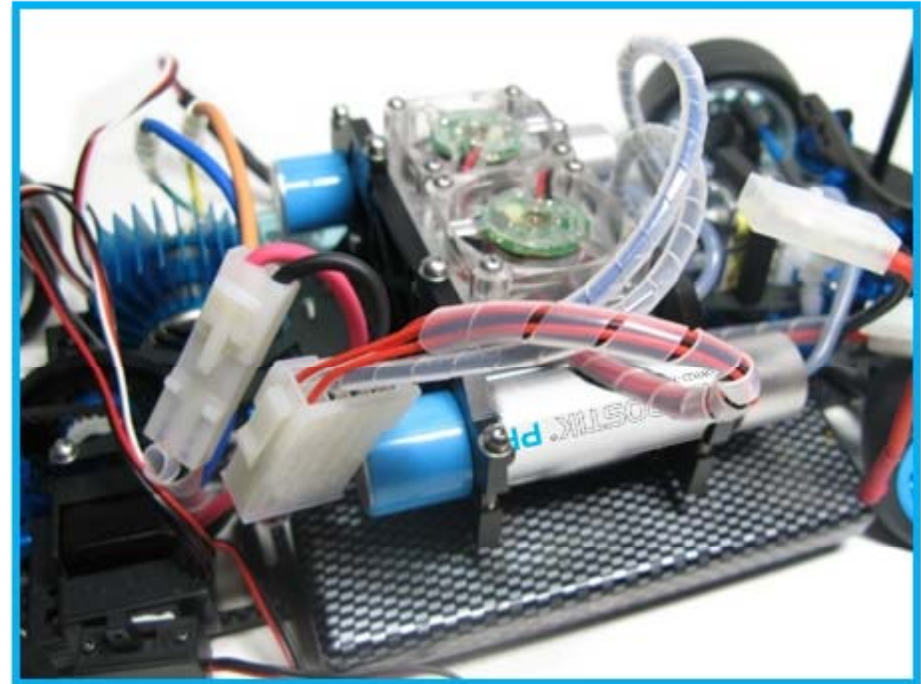
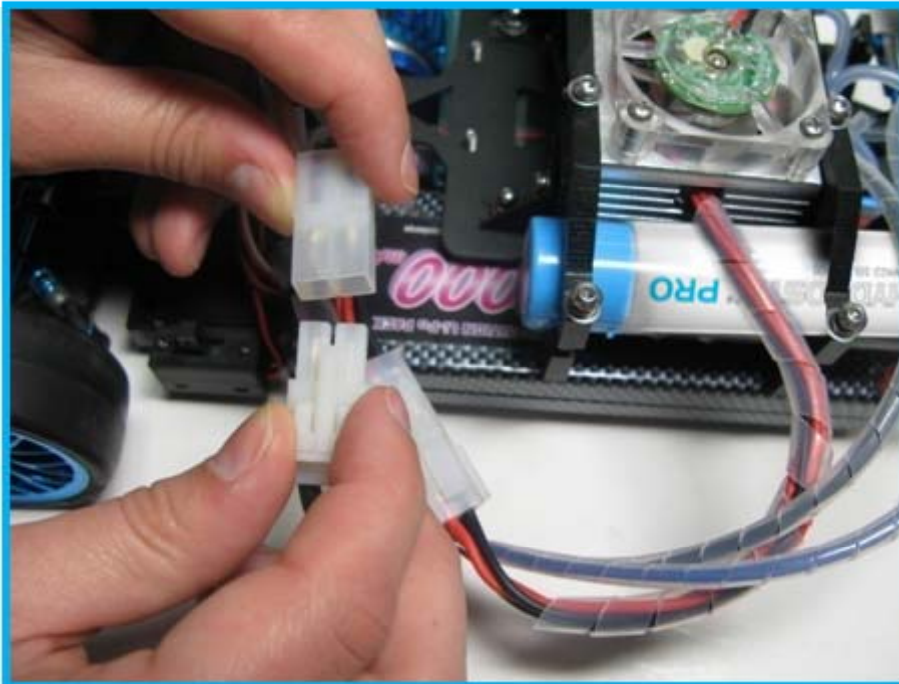

## STEP 15: Electronic connections

C. Follow the steps below to connect the electronic controller to the Lithium Battery.

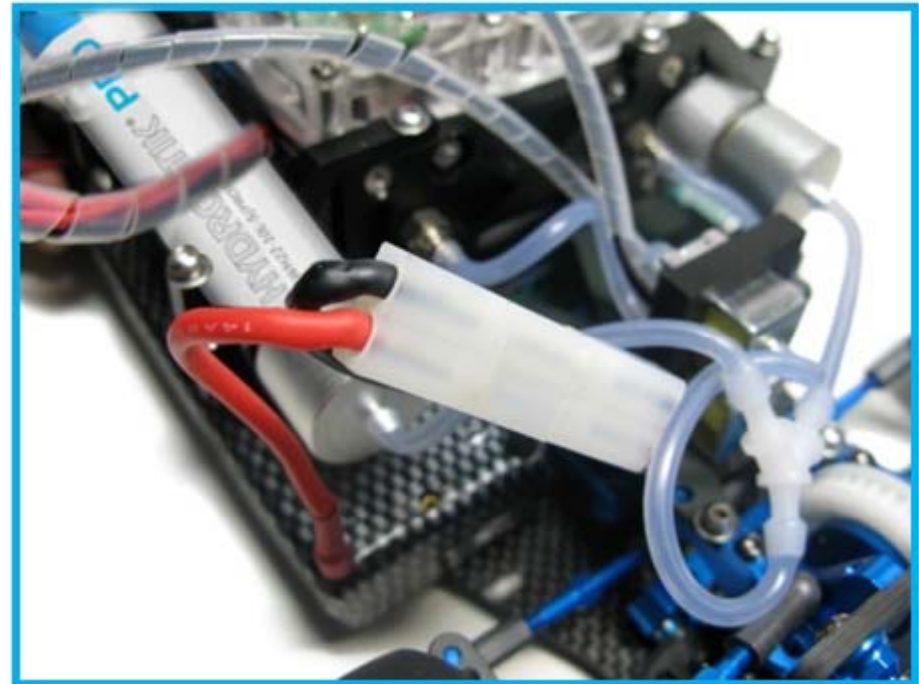
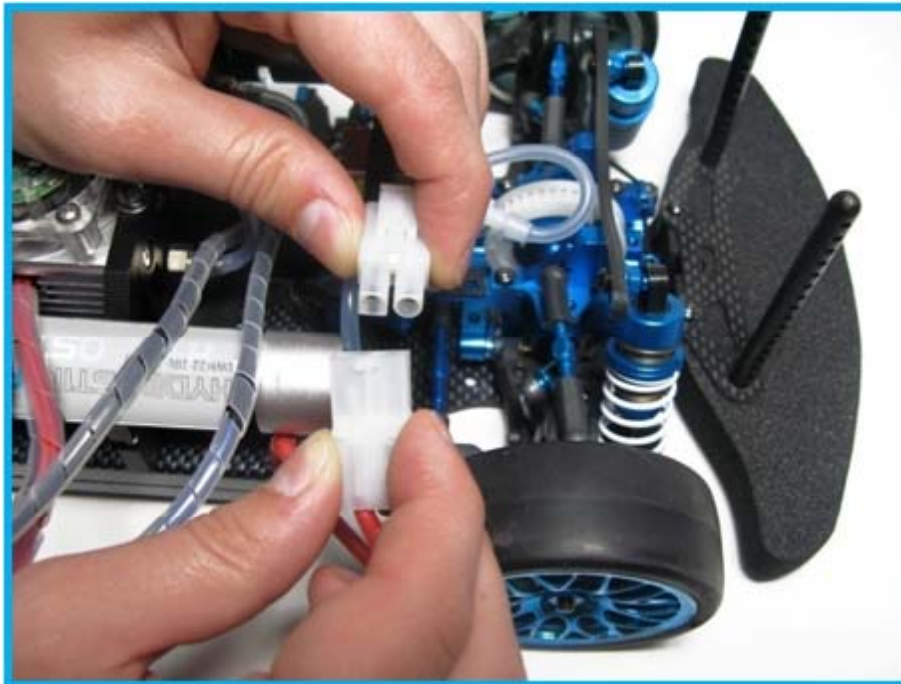

## STEP 16: Antenna connections

Push the antenna wire through the antenna tube. Insert the tube into the antenna base as below.

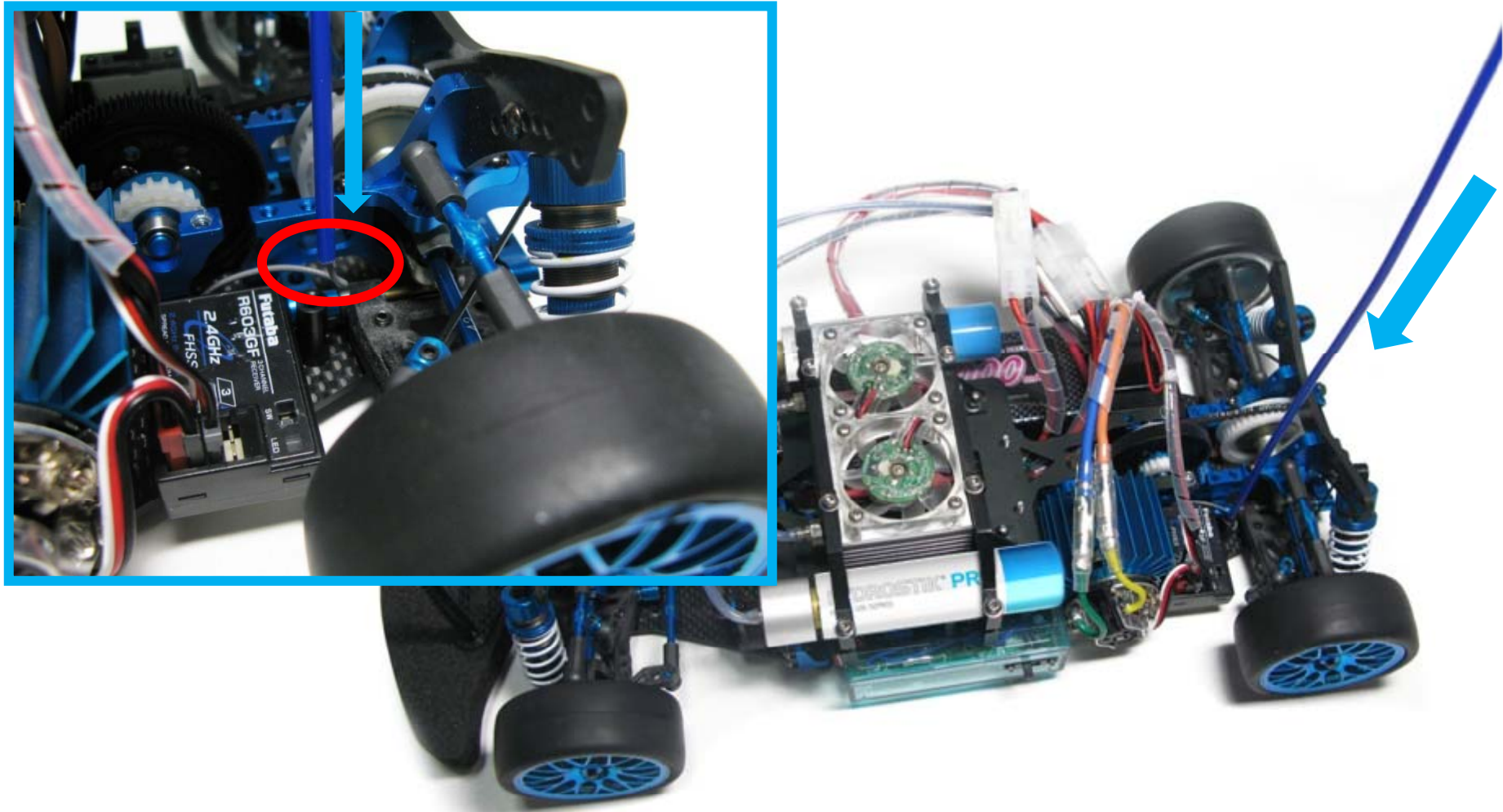

CONGRATULATIONS!

*Your hydrogen fuel cell hybrid RC car is now ready to go!*





## STEP 17: Turning the system “on”

Turn the gas switch to the “ON” position (A). The fans on the H-cell activate and the blue LED lights turn on. Turn on the receiver’s switch and activate the remote control unit. Use the RC unit to steer the car.

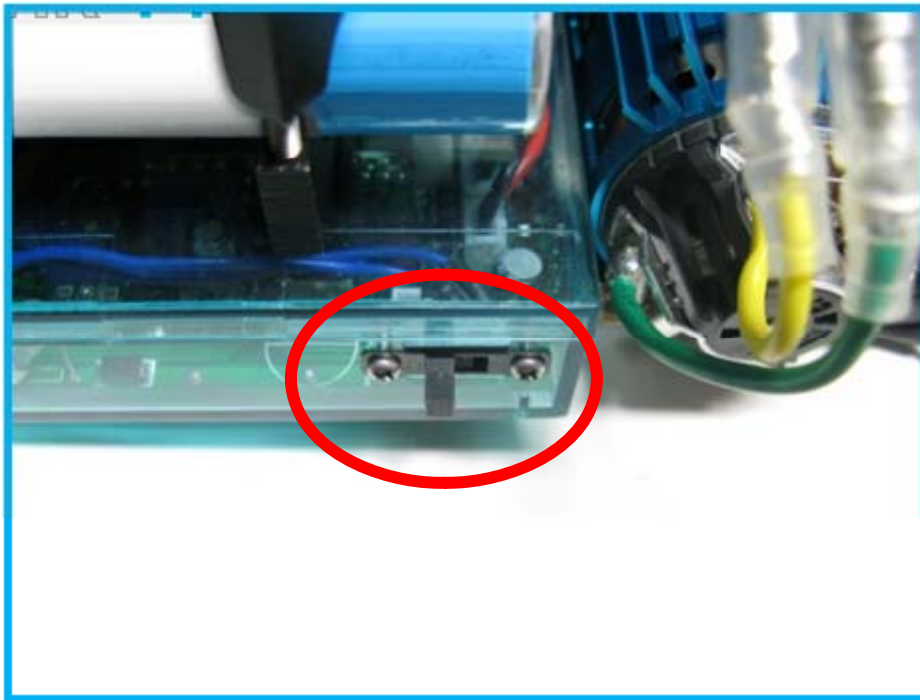

A



B



C

## **Additional recommendations (please read carefully):**

- 1. The electronic valves have input and output connections. HYDROSTIK PRO cartridges should only be connected to the input valve. If connected differently, the system will not function properly.*
- 2. To avoid failure of the control box which can be caused by battery power leakage, please disconnect the lithium battery from the control box after use.*
- 3. To avoid damage to the fuel cell, disconnect the HYDROSTIK PRO cartridges from the pressure regulators after use.*
- 4. If the fuel cell has not been used for a long time, please operate the fuel cell system first for 3 minutes before running the car.*
- 5. Store the fuel cell unit assembly in a ziplock plastic or air-tight box during storage to keep its cells hydrated.*

## Troubleshooting

**1. After turning on the electronic control box switch, the red light in the control box flashes, while the green light disappears. This indicates the Li-battery is drained and needs to be charged.**

### **Solution:**

- 1) Charge the battery.
- 2) Check the battery connection to the fuel cell system and reconnect it again.

**2. After turning on the electronic control box switch, the red light in the control box flashes, while the green light is on. This is a warning indicator that the battery voltage is low. It will be drained if you keep on using it.**

### **Solution:**

- 1) Charge the battery.
- 2) If it is already a newly charged battery, please change to a new one as it may be

**3. When you turn on the electronic controller box switch, the electronic controller box red light goes on, and the green light goes off. It shows the fuel cell voltage is low, but the Li-battery' voltage still meet the running requirement.**

### **Solution:**

- 1) HYDROSTIK cartridge is empty, use fully charged canisters.
- 2) Check the connection between the cartridge and the pressure regulator (B).
- 3) Check all the tubes connection.
- 4) Change a new fuel cell.

**Note:** *When you encounter such problems, first be sure to turn off the electronic control box (E) switch before attempting to resolve them*

**4. The red LED light flashes and then the system stopped automatically.**

### **Solution:**

Refill the metal hydride cartridge to the rated capacity.

## Troubleshooting (continued)

**5. While the car is running, the red light inside the electronic control box turns on and the green light turns off. This is a warning sign that the fuel cell voltage is low.**

**Solution:**

- 1) Canister is empty, use fully charged canisters.
- 2) Check the connection between the canister and the pressure regulator.
- 3) Check all the tubes connection.
- 4) Change a new fuel cell.

**6. While the car is running, the red light inside the electronic control box turns on and the green light flashes.**

**Solution:**

- 1) Please run the car within the temperature of 5-40°C.
- 2) The fuel cell was destroyed – you must use a new fuel cell to run the car.

**7. When the car is running, the both the red and green light flash inside the electronic control box.**

**Solution:**

Charge the battery.

**8. When you turn on the electronic controller box switch, no light turn on.**

**Solution:**

Check all the connections, especially the connections between speed controller to the antenna's signal receiver (see step 6).

- should you encounter additional problems, contact us at [sales@fuelcellstore.com](mailto:sales@fuelcellstore.com).